



THE UNIVERSITY *of* EDINBURGH

This thesis has been submitted in fulfilment of the requirements for a postgraduate degree (e.g. PhD, MPhil, DClinPsychol) at the University of Edinburgh. Please note the following terms and conditions of use:

- This work is protected by copyright and other intellectual property rights, which are retained by the thesis author, unless otherwise stated.
- A copy can be downloaded for personal non-commercial research or study, without prior permission or charge.
- This thesis cannot be reproduced or quoted extensively from without first obtaining permission in writing from the author.
- The content must not be changed in any way or sold commercially in any format or medium without the formal permission of the author.
- When referring to this work, full bibliographic details including the author, title, awarding institution and date of the thesis must be given.

**The Regular Plural Inside English Compounds Within
The Theory Of Base-Driven Stratification**

Amira Abdullah Al-Shehri

**Thesis submitted for the degree of Doctor of Philosophy
Linguistics and English Language
The University of Edinburgh
2014**

ABSTRACT

This literature-based thesis studies the phenomenon of the regular plural inside compounds according to Giegerich's (1999) stratal model of English morphology. The strata of his model are defined by their bases: stratum 1 is root-based and stratum 2 is word-based. The model overcomes the failings associated with earlier stratal models defined by their affixes (e.g., Kiparsky, 1982). However, assigning compounding and the regular plural to the same word stratum following Giegerich's (1999) model leaves an open question in terms of what restricts the interaction between both rules to prevent the generation of ill-formed compounds such as **toys box* and **trucks driver*.

Another question emerges: Should the regular plural inflection be assigned to stratum 2? This question is important because the answer affects how we discuss the interaction between the regular plural and compounding. For example, how do we account for the interaction between a stratum-2 rule and a syntactic rule if we are not dealing with an interaction of two lexical rules at the same stratum? This thesis challenges the theory that inflectional morphology is separate from the lexicon (Anderson, 1988, 1982; Perlmutter, 1988) with supporting evidence from the properties of the possessive inflection.

This research contributes significantly to the literature in its analysis of a number of compounds within texts extracted from books, which demonstrates that the internal regular plural morpheme has an evident semantic function that restricts it from appearing inside compounds (that is, on stratum 2 of the base-driven stratification model). The study thereby challenges Lieber and Štekauer's (2009) view that the internal regular plural morpheme is purposeless and therefore should be regarded as a linking element. I also argue that the possessive inflection is assigned to stratum 2 and can interact with compounding to form possessive compounds, but is restricted by the semantic feature of the non-head element.

ACKNOWLEDGEMENTS

I would like to express my deepest appreciation to my supervisor Professor Heinz Giegerich, who introduced me to the theory of base-driven stratification. Our discussions shaped the ideas in the thesis, particularly on the topic of the place of inflection. I thank him for his suggestions and comments on many drafts. Without his support, patience, and understanding of the challenges I faced as a full-time student and a mother of three, this thesis would not have been possible. From the bottom of my heart, thank you.

I would also like to thank Professor Roger Hawkins, who introduced me to the theory of level ordering in my Master's degree; Dr. Peter Ackema, for giving me time to discuss with him the theory of distributed morphology; Professor Peter Gordon, for emailing me his unpublished manuscript, *Why Compounds Researchers Aren't Rats Eaters: Semantic Constraints on Regular Plurals Inside Compounds*; and Professor Stephen Anderson, whose discussion of the syntactic status of possessive compounds inspired me to write § 5.3 of chapter II as a reply to him. I would like to thank Tabuk University, which generously funded my PhD study and living expenses.

I thank my parents and siblings, who have waited patiently for me to finish this long journey, and also my children Jouri, Rima, and Amjad, who often complained that I was not listening to them. I'm all ears, now.

Finally, my gratitude goes to my husband, Muhammed, who always supported and encouraged me in times of frustration. He took full responsibility of the children in my last six months of finishing this thesis, despite being a PhD student himself. This thesis is dedicated to him.

DECLARATION

I hereby declare that this thesis has been composed by me, and that has not been submitted for any other degree or professional qualification.

Amira Abdullah Al-Shehri

TABLE OF CONTENTS

INTRODUCTION.....	9
CHAPTER I: LEXICAL STRATA AND THE REGULAR PLURAL	
INSIDE COMPOUNDS.....	18
1. LEXICALISM.....	19
1.1 Lexicalism and the Fuzzy Nature of Compounds.....	27
1.1.1 The notion of word and compound.....	28
1.1.2 Phonological criterion: stress.....	34
1.1.3 Syntactic criteria.....	39
1.2 Rejection of Lexicalism	46
1.2.1 Distributed morphology	47
1.2.2 Distributed morphology versus lexicalism.....	53
2. LEXICAL STRATIFICATION MODELS.....	60
2.1 Level Ordering Theory.....	60
2.2 Suffixation is not Constrained by Affix-driven Restrictions.....	69
2.3 The Base-driven Approach to Lexical Stratification.....	76
2.3.1 The root stratum	77
2.3.2 The word stratum	80
2.3.3 The implementation of the base driven stratification	81
2.3.3.1 Morphology of the root stratum	82
2.3.3.2 Morphology of the word stratum	85
2.3.3.3 The Dual membership of affixes.....	86
2.3.3.4 Blocking effect and blocking failure.....	88
2.3.3.5 Compounding.....	90
2.3.3.6 The regular plural inside compounds.....	94

3. CONSTRAINTS AGAINST THE REGULAR PLURAL INSIDE COMPOUNDS.....	96
3.1 Morphological Constraint: Dual-Mechanism and Level Ordering.....	96
3.2 Constraints on the Associative Memory: Connectionism	99
3.2.1 Phonological-semantic constraint.....	100
3.2.2 Processing difficulty.....	111
4. THE ABSENCE OF THE REGULAR PLURAL INSIDE COMPOUNDS IS NOT A ROBUST PHENOMENON.....	113
5. CONCLUSION.....	118
CHAPTER II: THE PLACE OF INFLECTIONS IN THE STRATIFIED LEXICON: EVIDENCE FROM THE POSSESSIVE INFLECTIONS.....	120
1. SPLIT MORPHOLOGY HYPOTHESIS	122
1.1 Relevancy of Inflections to Syntax.....	126
2. THE LEXICAL APPROACH TO INFLECTIONS.....	129
2.1 Criteria of Distinctiveness between Derivation and Inflection.....	131
2.1.1 Productivity and paradigms.....	131
2.1.2 Semantics transparency.....	133
2.1.3 Change of word class.....	135
2.1.4 Obligatoriness.....	137
2.1.5 Affix ordering.....	138
3. THE WEAK VERSION OF SMH.....	140
4. THE POSSESSIVE AFFIX: CLITIC AND LEXICAL ANALYSES.....	144
4.1 POSS-S as a Clitic.....	145
4.2 POSS-S as a Lexical Affix.....	150
5. POSSESSIVE AFFIX IS NOT PHRASAL.....	155
5.1 Idiosyncrasy of Possessive Pronouns.....	155
5.2 Z Haplology.....	160

5.2.1 Zwicky's (1987) observation and analysis.....	160
5.2.2 Exceptions to z haplology.....	164
5.3 Possessive Compounds.....	169
5.3.1 Noun-noun and possessive compounds: structural and semantic comparison.....	175
5.3.2 The fuzziness of possessive compounds.....	179
5.3.2.1 Phonological criterion: stress.....	179
5.3.2.2 Syntactic criteria.....	181
5.3.3 Phrasal compounds.....	190
5.3.4 Onomastic possessives.....	199
6. CONCLUSION.....	202
CHAPTER III: THE FUNCTION OF THE REGULAR PLURAL INSIDE COMPOUNDS.....	206
1. THE MEDIAL S AS A LINKING ELEMENT.....	208
1.1 Linking Elements in German N-N Compounds.....	209
1.1.1 Linking elements as relics of the genitive singular inflection (-es, - s, -en, -e).....	210
1.1.2 Linking elements as relics of the plural inflection (-er, -e, -(e)n, - s).....	213
1.2 The Regular Plural inside English Compounds is not a Linking Element.....	215
2. THE MEDIAL S AS A POSSESSIVE MORPHEME.....	218
2.1 Distribution of the Possessive Inflection inside Compounds	220
2.2 Possessive Compounds and the BDS Model.....	229
3. THE MEDIAL S AS A PART OF THE NON-HEAD NOUN.....	233
3.1 Pluralia Tantum and Compounding.....	238
4. PRE-MODIFIED REGULAR PLURALS INSIDE COMPOUNDS.....	244

5. SEMANTIC FUNCTION OF THE REGULAR PLURAL INSIDE	
COMPOUNDS.....	245
5.1 Polysemy.....	246
5.1.1 Categories of polysemy and regular pluralisation within	
Compounds.....	250
5.1.1.1 Type/ token polysemy.....	250
5.1.1.1.1 ‘One type/ many types’ ambiguity and other overlapping	
factors.....	257
5.1.1.1.2 Mass/ count polysemy.....	259
5.1.1.1.3 Text/ object (or content/ container) polysemy.....	266
5.1.1.1.4 Adjective/ noun polysemy.....	268
6. Discussion and Conclusion.....	271
CHAPTER IV: CONCLUSION.....	277
1. SYNTHESIS.....	277
2. THEORETICAL IMPLICATIONS.....	286
3. FUTURE RESEARCH.....	290
4. CONCLUSION.....	291
REFERENCES.....	292

INTRODUCTION

The present research will address the problem of the regular plural in the juncture position in compounds within Giegerich's (1999) theory of base-driven stratification. In this introductory section, I will discuss the phenomenon, the main problem, and the key issues related to the problem, and then will describe the structure of the thesis.

1. THE PHENOMENON

The left member of most English compounds is uninflected, which is a phenomenon recognised many years ago (e.g. Jespersen, 1954). The head, or final, member of compound specifies the referent and the number of the compound, whereas the first element functions as a complement or an argument to the head. It is usually preferred that the first member remain in uninflected form even if the plural interpretation is intended. Pinker (1999, p. 178) illuminates this idea in the following quote:

We speak of anteaters, bird-watchers, Beatle records, Yankee fans, two pound bags, three week vacations, and all-season tires, even though it's ants that are eaten, birds that are watched, all four Beatles that played on *Sgt. Pepper's* and the white album, and so on.

On the other hand, the irregular plural within compounds is not problematic. In the examples below, irregular and regular plurals are

semantically matched, but only the irregular inflection as an internal inflection is allowed:

- | | | |
|-----|---------------|------------------|
| (1) | feet-first | * heads-first |
| | mice-infested | * rats-infested |
| | teeth-marks | * dentures-marks |
| | alumni club | * students-club |
| | menfolk | * androids-folk |

(Sproat, 1985, p. 413)

The distinction in the behaviour between the regular and irregular plural within compounds demonstrated above has implications for several morphological and psycholinguistic theories, invoking intense discussions about the structure of grammar and morphological processing. Proponents of the dual-mechanism theory (e.g. Berent & Pinker, 2007; Cunnings & Clahsen, 2007; Clahsen, 1995; Pinker & Prince, 1992, 1988) have attributed the dichotomy to the distinct processes underlying the formation of regular and irregular inflection. According to them, a regular plural noun is generated by means of morphological concatenation (e.g. $[\text{car}]_N + [-s]_{\text{PLURAL}} = [\text{car}]_N[-s]_{\text{PLURAL}}]$) in the mental grammar; this prevents the plural noun from feeding back into a lexical rule such as compounding. Irregular plurals, on the other hand, are stored in the mental lexicon and, as a consequence, can be input for compounding. This theory agrees in essence with that of level ordering (Kiparsky, 1982) in that the acceptability of the irregular plural inside the compound is evidence that the irregular plural is qualitatively different from the regular plural. Level ordering differs from dual mechanism with regard to the structure of the lexicon, however. Level

ordering stratifies the lexicon into three levels: the irregular plural is assigned to stratum 1, compounding to stratum 2, and the regular plural to stratum 3. The rules for these levels apply sequentially in the sense that the rules of level 2 cannot apply before the rules of level 1, and the rules of level 3 cannot apply before the rules of levels 1 and 2. Gordon (1985) and Kiparsky (1982) claimed that level ordering gives adequate explanation for the phenomenon in question in that the irregular plural can feed into compounding, while it is too late for the regular plural to do the same.

Proponents of connectionism, on the other hand, argue that both regular and irregular plurals are handled by the associative memory. In general, Haskell et al. (2003) suggest that native speakers of English do not use the regular plural inside compounds because modifiers ending with /s/ or /z/ are not part of their innate knowledge. They suggest that there is a phonological and semantic constraint against adjectival modifiers in English, and that this knowledge is generalised to include modifiers within compounds.

2. THE PROBLEM

The theories described assume that the absence of the regular plural inside compounds is robust. However, the medial *s* in the examples below is a real plural suffix:

- (2) a. publications catalogue
- b. antiques shop
- c. documents analysis
- d. vehicles industry
- e. paintings collection

Publications, antiques, documents, vehicles, paintings reflect the number opposition of their counterparts, *publication, antique, document, vehicle, painting*; in other words, no special meaning is conveyed through the plural morpheme. Examples like those in (2) cast doubt on the efficacy of the theories mentioned above. For the level ordering theory, they violate the stratal constraint and the regular plural is allowed to feed back into compounding. For the dual mechanism theory, the examples violate the restriction against a concatenative form (stem + -s) to interact with compounding. For connectionism, the examples prove wrong the basic assumption that plural modifiers within compounds are inherently avoided by native English speakers. Thus, 'The regular plural never appears inside compounds' is a misleading generalisation.

The structure of the lexicon in the base-driven stratification (BDS) theory, on the other hand, allows for compounds to generate by assigning the regular plural and compounding to the same stratum. This thesis seeks to discover what motivates this interaction to avoid generating otherwise unacceptable compounds such as **trucks driver*. The study of this motivation is related to two issues that illuminate how one may discuss the basic problem. These issues are as follows:

(a) The status of the regular plural: lexical or phrasal?

Before discussing the question concerning the restriction of the interaction between the regular plural and compounding, we must determine whether or not we are dealing with an interaction between two lexical rules. If the regular plural is a phrasal suffix, how can we account for its presence inside compounds? Three theories will be assessed.

1. Inflectional morphology should be separated from the lexicon, which is the basis of a theory known as the split morphology hypothesis (SMH) (Anderson, 1982, 1988, 1992).
2. Inflectional morphology is part of the lexicon (Booij, 1994, 1996, 1998).
3. Unproductive inflections are part of the lexicon, while productive inflections are generated extra-lexically (Perlmutter, 1988).

As far as the BDS model is concerned, there are three possibilities in accordance with the theories of inflectional morphology outlined above:

1. Inflections apply outside the stratified lexicon.
2. Non-productive inflections apply at stratum 1 while productive inflections apply at stratum 2.
3. Non-productive inflections apply at stratum 1 while productive inflections are in syntax.

The investigation of the properties of the possessive inflection, which is largely claimed to be a clitic, concluded that inflections should be part of the lexicon; hence, the original assumption of the BDS model will be maintained.

(b) The regular plural found inside compounds is a linking element

Lieber and Štekauer (2009) claim that the issue of plurality inside compounds should be attributed to linking elements, which are meaningless extensions similar to those found inside compounds in other Germanic languages. Their claim is based on the existence of a pair of compounds such as *programme list* versus *programmes list*; the plural interpretation of the non-head is understood with or without the presence of an internal regular plural. Thus, they argue that the plural is purposeless.

In German compounds, the emptiness of internal elements is evident. For example, the plural interpretation of the non-head in *Kindergarten* 'kindergarten' is felt, but there is no plausible reason to believe that *-er* is a genuine plural suffix for two reasons: (i) the non-head is generic and, most importantly, (ii) other compounds contain the plural suffix *-er* but it does not affect the singular interpretation of the non-head (e.g., *Kinderstar* 'child star').

The present research argues that, for English compounds, the regular plural inside compounds has an evident semantic function, which will also answer the primary question of this research: What motivates the regular plural to interact with compounding at stratum 2?

3. THE STRUCTURE OF THE THESIS

Chapter I starts with an overview of lexicalism in (§ 1); lexicalism stipulates that morphology must have an independent component from syntax. It then discusses the rejection of lexicalism by the theory of

distributed morphology (DM). However, DM does not prove to be a better alternative to lexicalism, as its proponents explicitly claim (e.g. Marantz, 1997); in (§ 1.1.2), I present the weaknesses resulting from the demolition not only of morphology but also of the lexicon itself, with attention to DM's failure to account for the appearance of the regular plural inside compounds. In (§ 2), lexical stratification models are introduced. In (§ 2.1), the basic tenets of level ordering, known as the affix-stratification theory, are described with particular attention to the morphological side. In (§ 2.2) are discussed serious problems associated with the theory, which are the result of the basic motivation of the stratification itself, indicating that the lexicon is stratified primarily according to the characteristics of affixes. In (§ 2.3), the theory of base-driven stratification is presented and shown to be a more successful alternative to affix-driven stratification. It is within the BDS theory that the problem of this research is addressed. Neither model, however, provides a satisfactory solution for the appearance of the regular plural inside compounds. In (§ 3) are discussed constraints proposed in the literature against the regular plural appearing within compounds in comparison to the acceptability of irregular plurals: (§ 3.1) discusses morphological constraints within dual-mechanism and level ordering, (§ 3.2.1) describes phonological and semantic constraints, and (§ 3.2.2) covers processing difficulties resulting from phonological and orthographic effects. The last two are recognised within the theory of connectionism, as summarised in (§ 3.2). However, the accounts of such theories are problematic because the generalisation on

which they are based are in fact inaccurate, as discussed in (§ 4). The regular plural is not robustly absent within compounds. The chapter is concluded in (§ 5).

Chapter II defends BDS with respect to the place of inflection in the stratified lexicon. Three theories will be reviewed. In (§ 1) is introduced Anderson's (1982, 1992) split morphology hypothesis, in which inflections must be separated from the lexicon. As described in (§ 1.1) Anderson (1982, 1992) argued that the relevancy of inflections to syntax is the criterion on which his theory of inflection relies. In (§ 2) Booijs (1994, 1996, 1998) argument against SMH is presented. Booijs (1994, 1996, 1998) showed that inherent inflections have the hallmarks of derivations in respect of five criteria, as discussed in (§ 2.1.1)–(§ 2.1.5): (§ 2.1.1) discusses productivity, (§ 2.1.2) discusses semantic transparency, (§ 2.1.3) discusses change of word class, (§ 2.1.4) discusses obligatoriness, and (§ 2.1.5) discusses affix ordering. In (§ 3), Perlumtter's (1988) weaker version of SMH is discussed. According to him, only regular inflections should be split from morphology.

The rest of the chapter will support Booijs (1994, 1996, 1998) lexical approach to inflections. Evidence comes from the characteristics of the possessive affix, which is a contextual inflection. In (§ 4), the syntactic and morphological analyses of the possessive affix are reviewed. In (§ 5) are discussed in detail three kinds of evidence for the lexical status of the possessive: (§ 5.1) describes the idiosyncrasy of possessive pronouns, (§ 5.2)

discusses *Z* haplology, and (§ 5.3) covers the appearance of the possessive morpheme inside compounds. The chapter concludes in (§ 6).

Chapter III discusses the function of the regular plural inside compounds. In (§ 1), Lieber and Štekauer's (2009) claim that the regular plural should be regarded as a linking element is discussed. In (§ 1.1), the linking elements in German are reviewed. In (§ 1.2), I argue that the regular plural inside English compounds is not a linking element, but rather has a semantic function. Before analysing its function, three issues are discussed: (§ 2) describes the distribution of the possessive morpheme inside compounds, (§ 3) discusses the pluralia tantum and their appearance inside compounds, and (§ 4) covers plural phrases embedded in compounds.

In (§ 5), the semantic function of the regular plural inside compounds is analysed. The relationship between polysemy and internal regular pluralisation is also introduced in (§ 5). Four categories of polysemy are outlined according to their relevance to the issue in question: type/token polysemy, mass/count polysemy, text/object polysemy, and adjective/noun polysemy. The chapter ends with a discussion and conclusion in (§ 6).

Chapter IV presents a synthesis of the arguments discussed in the research in (§ 1), followed by a discussion on the theoretical implications in (§ 2). In (§ 3) is introduced a plan for future research, followed by a conclusion, which is provided in (§ 4).

CHAPTER I

LEXICAL STRATIFICATION AND THE REGULAR PLURAL INSIDE ENGLISH COMPOUNDS

The aim of this chapter is to discuss the rationale behind choosing Giegerich's (1999) base-driven stratification model to approach the phenomenon of the regular plural inside English compounds, as well as the gap that needs to be addressed.

This chapter starts with an overview of the theory of lexicalism (§ 1), followed by a discussion in (§ 1.1) on the hybrid behaviour of compounds that challenges the sharp lexicon-syntax divide. In (§ 1.2), I explore a theory that rejects lexicalism, namely, distributed morphology (DM) (Halle & Marantz, 1993; Harley, 2009; Harley & Noyer, 1999; Marantz, 1997, 2001, 2007), followed by a discussion on why DM cannot replace lexicalism as its proponents explicitly claim; most importantly, words must have a generative system of their own (§ 1.2.2).

In (§ 2), affix-driven stratificational models of English morphology (e.g., Allen, 1978; Halle & Mohanan, 1985; Kiparsky, 1982; Siegel, 1974) will be reviewed. The models encounter empirical and theoretical problems discussed in (§ 2.2) that have led to the rejection of the stratified approach. However, the discussion in (§ 2.3) shows that the stratified approach can be maintained if it is base driven, as convincingly argued by Giegerich (1999). The implementation of the base-driven stratification model will be

demonstrated in (§ 2.3.3), ending with a discussion on the gap associated with the presence of the regular plural inside compounds. The subsequent discussion in (§ 3) will focus on constraints within different theories against the regular plural: morphological constraint within dual-mechanism and level ordering (§ 3.1), phonological and semantic constraint, and phonological and orthographical within connectionism (§ 3.2). As pointed out in (§ 4), these theories used the absence of the regular plural inside compounds as a supportive phenomenon, yet in fact a robust absence is inaccurate. The chapter ends with a conclusion in (§ 5).

1. LEXICALISM

In Chomsky's Standard Theory (1965), word formation processes are handled by syntax; compounding, derivational and inflectional aspects are governed by syntactic transformational rules. In this model, the deep structure of sentences is formed in the base component via a set of phrase structure rules, which then undergoes a set of transformational rules that convert the deep structure by means of deletion, addition or substitution into the surface structure. For Lees (1960) and Marchand (1965a, 1965b), a compound is generated from an underlying syntactic structure. It mirrors one of the eight kinds of the underlying grammatical relations (Lees, 1960, pp. 125-168):

(1) Phrase → compound: eight grammatical relations:

- a. Subject-Predicate: "the plane is a fighter" → *fighter plane*
- b. Subject-Middle Object: "the bone has marrow" → *marrow bone*
- c. Subject-Verb: "the bird wades" → *wading bird*
- d. Subject-Object: "dog which the police use" or "dog which serves the police"¹ → *police dog*
- e. Verb-Object: "(John) pushes the button" → *pushbutton*
- f. Subject-Prepositional Object: "the cream is for coffee" → *coffee cream*
- g. Verb-Prepositional Object: "(John) grinds knives on the stone" → *grindstone*
- h. Object-Prepositional Object: "we teach the grammar in school" → *school grammar*

Chomsky's structure of grammar also contains semantic and phonological components. The meaning of sentences is determined from their deep structures, whilst their phonology is determined from their surface structures (e.g. the alternation between *sane* [sem] and *sanity* [sænitɪ] is dealt with at the phonological component) (Katamba, 1993, p. 11). The components of the grammar are thus able to *generate* well-formed words without the need for an autonomous morphology.

In Chomsky & Halle (1968), morphological rules were divided between syntax and phonology. Both the regular and irregular past tenses are formed in syntax and their outputs are sent to undergo readjustment rules before they are finally realised in the phonological component, the rules that Katamba (1993, p. 11) described as 'morphological rules in disguise'. One example provided in Katamba (p. 12) is the past tense forms of *amend* and

¹ The verb here is omitted and according to Lees (1960, p. 143) it can be assumed.

sing generated in syntax $[_v[_v\text{amend}]_v\text{past}]_v$ and $[_v[_v\text{sing}]_v\text{past}]_v$. Having undergone the readjustment rules, the bracketing is deleted and replaced with *d* in the case of *amend* to be finally spelled out as *amended*. The bracketing of the irregular form and the feature *past* are also deleted, and the vowel /ɪ/ is replaced with * to be eventually realised as [sæŋ] in the phonological component.

In such theories, the role of the lexicon is very limited. Fabb (1984) and Sproat (1985) viewed the lexicon as a component where stems, affixes and idiosyncrasies are stored, and the well-formedness of a word is determined by two kinds of principles: syntactic principles that yield a well-formed syntactic structure (e.g. theta theory, projection principles, binding theory, X-bar theory, case theory) and phonological principles that result in its phonological well-formedness.

In *Remarks on Nominalisation* (1970), Chomsky deviated from the argument in Standard Theory; morphology is a sub-system of the lexicon so it should be recognised as a generative system independent from syntax. The role of the lexicon in this theory is thus widened. It is not only storage of lexical items and idiosyncrasies, but also a locus of lexical operations that are responsible for word formations.² This influential work of Chomsky's has

² There is also another position towards the lexicon: Ackema & Neeleman (2007, pp. 326-327) argued that that morphology is not a sub-system of the lexicon, and syntax and morphology are alike with regards to their relationship with the lexicon:

There is no special relationship between morphology and the lexicon – the relationship between words and the lexicon is not different from the relationship between phrases and the lexicon. Any complex word with

been followed by a period of extensive work on the evolution of generative grammar known as 'lexicalism'.

Proponents of lexicalism strongly argue that morphological constructions cannot be handled by syntactic rules; their substantial differences from syntactic constructions justify proposing a separate morphological component.

According to Standard Theory, derived nominals and gerunds are generated by the same mechanism, i.e. from corresponding underlying syntactic structures. However, Chomsky (1970, p. 188) observed striking differences between these types of nominalisation; as he pointed out:

Derived nominals ... are very different (*from gerunds*) ... Productivity is much more restricted, the semantic relations between the associated proposition and the derived nominal are quite varied, and idiosyncratic, and the nominal has the internal structure of a noun phrase.

On morphological grounds, there is restriction on productivity; all verbs can be transformed into gerunds by suffixation with *-ing*, but not all verbs can be derived into nominals in predictable ways.

- (2) a. John is easy (difficult) to please
b. John is certain (likely) to win the prize
c. John amused (interested) the children with his stories

- (3) a. John's being easy (difficult) to please
b. John's being certain (likely) to win the prize
c. John's amusing (interesting) the children with his stories

fully predictable properties (predictable from the principles of grammar, that is), just like any complex phrase with fully predictable properties, will not be listed in the lexicon. Conversely, any phrase with some unpredictable property, just like any word with some unpredictable property, is listed.

- (4) a. * John's easiness (difficulty) to please
 b. * John's certainty (likelihood) to win the prize
 c. * John's amusement (interest) of the children with his stories
 (Chomsky, 1970, pp. 188–189)

Regarding the internal structure of the noun phrase, there is a similarity between verbs and their gerundive correspondences; this is also observed in example (3c) in which the gerund noun *amusing* can have a direct object whilst that is impossible for the derived noun *amusement*, which is associated with a preposition. Moreover, gerunds and their underlying verbs can be modified by adverbs, whilst derived nominalisation can be modified by adjectives:

- (5) a. Dick's $\left\{ \begin{array}{l} \text{sarcastically} \\ \text{*sarcastic} \end{array} \right\}$ criticising the book
 b. Dick's $\left\{ \begin{array}{l} \text{*sarcastically} \\ \text{sarcastic} \end{array} \right\}$ criticism of the book
 (Spencer, 1991, p. 70)

Gerunds and derived nominalisation also differ semantically. According to Spencer (1991), a gerund is highly transparent. It is just a nominal form that reflects the meaning of its verb base whether it denotes a state or action. The semantics of derived nominalisation, on the other hand, might not reflect the exact meaning of its verb base; the new form may convey an additional meaning. For example, *amusement* in (6a) gives the condition of being amused as a result of Tom's story, a sense that cannot be conveyed if *amusement* is replaced by *amusing*:

- (6) a. Tom's story provided endless *amusement*
b. *Tom's story provided endless *amusing*
(Spencer, 1991, p. 70)

Williams (2007) argued that 'phrasal and word systems'³ should be treated as two different systems, which is strongly supported by the way anaphors are identified in both systems⁴. If an anaphor occurs within a lexical structure, its antecedency must be immediately resolved.

- (7) John told *self destruction* stories
(Williams, 2007, p. 354)

In (7) *self* cannot be identified with *John* because it is not in the immediate constituent. The antecedent that must be identified with is the agent of the predicate *destruction*. The phrasal system, on the other hand, allows for 'delayed resolution'. The antecedent may not be contained within the phrase in which the anaphor appears. In the example below, the anaphor *himself* and its antecedent are separated by a number of constituents [prepositional phrase PP, noun phrase NP, PP, NP, and verb phrase VP].

- (8) John told stories about the destruction of *himself*
(Williams, 2007, p. 354)

Cross-linguistic evidence that morphology has an independent component is discussed in Ackema & Neeleman (2007). There are two kinds

³ Williams (2007) used the terms 'word system' and 'phrasal system' to refer to the components of morphology/lexicon and syntax, respectively. He argued that syntax can be used for words and phrases since both have constituents that are subject to rules and principles that govern their assemblies. He suggested that the term 'word and phrasal systems' should be better used in the discussions of lexical/phrasal interface to avoid confusion.

⁴ The term 'anaphor' refers to an expression that cannot stand on its own and it must refer to something mentioned before, known as antecedents, within the same sentence or phrase.

of heads in languages like Dutch and Swedish: syntactic (e.g. verb clusters, particle-verbs⁵, and resultative-verb constructs⁶) and morphological (as in compounds). Both are constructed in syntax as proponents of syntactic theories of word-formation claim, thereby predicting that their behaviour should be similar. However, Ackema & Neeleman showed that their behaviour is in fact contrastive, which is best explained by lexicalist theories. One criterion of distinctiveness between syntactic and morphological complex X^os is the position of the head in these constructions. As in English, words in Dutch and Swedish are always right-headed. On the other hand, the position of syntactically complex heads in these languages varies because each language has its specific syntactic parameter that governs the position of these heads in verb phrases VPs. For example, Ackema & Neeleman noted that in English and Swedish the verb precedes the object (i.e. VO languages), and consequently the particle-verb construction is left-headed (i.e. the particle is on the right). Conversely, Dutch is an OV language; the VP is right-headed and, consequently, the particle-verb is right-headed⁷:

- (9) a. *Jan zal het feit [V op_P zoeken_V]* Dutch
 John will the fact up look
- b. John [V sat_V down_P] slowly English
- c. *Jag [V bryter_V av_P] kvisten* Swedish
 I break off the-branch

⁵ This is also termed phrasal verbs.

⁶ Resultative verbs are complex verbs in which the second element refers to the result meaning of the verb (e.g. *Fred watered the plants flat* (Goldberg & Jackendoff, 2004, p. 533)).

⁷ Examples (9-12) are taken from Ackema & Neeleman (2007, pp. 337-338).

The second criterion is that syntactic complex heads do not undergo further verb formation, a restriction known as the ‘complexity constraint’. In Dutch, for example, resultative-verbs and particle-verbs do not accept recursion. As in the example below, the sentence is ungrammatical because the resultative-verb is headed by the particle-verb *samenwerken* ‘together-work’:

- (10) **Ik geloof dat Jan en Piet zich [kapot [samen werken]]*
 I think that John and Pete themselves to-pieces together-work
 ‘I think that John and Pete cooperate so much that it exhausts them’

In contrast, the morphological complex X^0 s (e.g. N-V compounds) is not governed by the complexity constraint so it is allowed to head complex predicates.

- (11) ...*dat Jan zich [suf [stijl danst]]*
 ... that John himself drowsy style dances
 ‘...that John ballroom-dances so much that he becomes drowsy’

Finally, the infinitive *te* in Dutch is allowed to appear as a non-head in syntactic X^0 s, but it is not licensed in morphological complexes.

- (12) a. *[[(*te) staan] plaats]*
 (to) stand place
 ‘standing room’
- b. ...*dat hij haar [heeft [proberen te verstaan]]*
 ...that he her has try to understand
 ‘...that he has tried to understand her’

It should also be noted that one of the most controversial issues arising from research in the lexicalist tradition is whether all morphological phenomena should be formed in the lexicon. In this respect, lexicalism has developed two different approaches: strong and weak lexicalist hypotheses.

The strong lexicalist hypothesis holds that derivation, inflection and compounding are formed in the lexicon (e.g., Kiparsky, 1982; Lapointe, 1980; Lieber, 1981; Williams, 1981). Anderson (1992) proposed a weaker version based mainly on the differences between derivation and inflection. Inflectional morphology does not take place in the lexicon; it has a morphosyntactic property, so it takes place at a level where it can interact with syntax—a theory Perlmutter (1988) called the split morphology hypothesis (SMH) (I return to this in Chapter II). On the other hand, other linguists, such as Halle & Mohanan (1985) and Kiparsky (1982), have proposed that inflections and derivations are represented in the lexicon and the differences can be explained in terms of a stratified lexicon. However, the sharp divide between the lexicon and syntax is questioned by the existence of many English compound words that have characteristics associated with syntax. In the following section, I will discuss the fuzzy nature of compounds, followed by a discussion of its implication on the Lexical Integrity Hypothesis (LIH).

1.1 Lexicalism and the Fuzzy Nature of Compounds

In some languages, a compound is recognised easily; for example, in Slovak, compounds are distinguished by the fact that the non-head noun cannot be inflected and it contains the linking element *-o-* (e.g. *rýchlovlak* ‘express train’) (Lieber & Štekauer, 2009, p. 5). In Germanic languages other than English, orthography can be a reliable test for distinguishing

compounds from phrases. German compounds, for example, are written as single words (e.g. *Abendsitzung* 'evening session') whilst phrases are written as two constituents (e.g. *schwarze drossel* 'black thrush') (Giegerich, 2009a, p. 184). Very old English compounds were also written as single words (e.g. *blackbird*), but this convention does not exist with new compounds (Hüning, 2008); some are spelled as single words (e.g. *ashtray, windmill, hotline*); others are separated by a hyphen (e.g. *fast-food, icy-cold*) or without a hyphen (e.g. *income tax increase, education minister*) (examples from Plag, Braun, Lappe, & Schramm, 2009, p. 100). Sometimes a single compound may be written inconsistently; for example, the compound *secondhand* has been shown in its three variations in the *American Heritage Dictionary*, i.e. *secondhand, second hand and second-hand* (Venezky, 1999, p. 23).

In fact, much debate has arisen in the literature in terms of what constitutes a compound, and no satisfactorily appropriate definition has yet emerged. The difficulty in finding a proper definition is linked mainly to two issues that will be discussed herein: (i) the confusion of what constitutes a word and, most importantly, (ii) the difficulty of establishing a clean distinction between compounds and phrases.

1.1.1 The notion of word and compound

(a) *The traditional notion of word:* In traditional grammar, a word is viewed as (i) smallest unit of syntax or the building-block from which phrases and sentences are formed. However, when we look at a word on its

own (i.e., outside sentences), it might be viewed as (ii) “a building-block with a meaning that is unpredictable, or at least sufficiently unpredictable that learners of English, and even sometimes native speakers, may need to consult a dictionary in order to discover it” (Carstairs-McCarthy, 2002, p. 5). The prototypical word is consistent with both definitions (e.g., *coffee* is listed in the dictionary and is used as a building-block). Yet in terms of the first definition, there are units composed of more than one word, like compounds (e.g., *clergyman-poet*), phrasal idioms (e.g., *kick the bucket*), and collocations (e.g., *white coffee*). For the second definition, not all building-blocks are so semantically unpredictable that they require being listed in the dictionary; for example, many people would need to consult a dictionary to discover the meaning of *dioecious*, but once they learn it they can guess or predict what *dioeciously* means (Carstairs-McCarthy, 2002, pp. 7-8). The word *dioecious* is better called a ‘lexical item’; yet, this term is fuzzy since it may include phrases or expressions that have lost their meaning over time and are now eligible for listing. Alternatively, Di Sciullo & Williams (1987) use the term ‘listeme’ to refer to all items listed in the lexicon, regardless of their size; for example, the fixed expression *to put the cat among the pigeons* is a listeme, which is different from another term called ‘lexeme’ explained below:

(b) Lexemes and varying forms: Fabb (1998, p. 66) stated that a “compound is a word which consists of two or more words”. The phrase ‘two or more words’ instead of a compound that it is made up of two words would avoid the problem of compounds whose non-head position is

occupied by more than one element (e.g. *power source requirement, engine communication error, communication technology equipment*; Plag, 2003, p. 133), which is due to the recursive property of compounds⁸. However, the problem with Fabb's definition comes from the ambiguity of the definition of the word itself, which stems from the word being used in different senses. According to Katamba (1993, pp. 17–19), the term word can refer to three senses: the lexeme, word-form and grammatical word. The lexeme is the vocabulary item listed in dictionary, and it may have different realisations. For example, the lexeme (or word) TALK is found in the dictionary and can be realised as *talked, talking* and *talks*. In the other way round, word form refers to the different realisations of the same lexeme; *talked, talking* and *talks* are all word forms of the same lexeme TALK. When word forms of the same lexeme bear morphosyntactic features (e.g. verb, adjective, noun), they are called grammatical words.

In his definition, Bauer (2003, p. 40) used the term 'lexeme': "the formation of a new lexeme adjoining two or more lexemes". According to Lieber & Štekauer (2009), the advantage of using this term is that it excludes

⁸ Plag (2003, p. 133) explained that compounds are 'binary structures'. Consider *university teaching award committee member*, the phrase '*teaching award*' consists of two elements, '*teaching*' and '*award*', the next longer structure '*university teaching award*' consists of two elements as well, '*university*' and '*teaching award*', the following longer structure '*university teaching award committee*' is made up of two elements '*university teaching award*' and '*committee*' and the final structure '*university teaching award committee member*' is formed by combining two elements '*university teaching award committee*' and '*member*'. Moreover, such compounds, mainly noun-noun compounds, can be extended to form new compounds, a property of compound formation called 'recursivity' (e.g. *university teaching award committee member training*).

affixes, but includes roots, stems and free forms. However, there are cases in which affixes can be confused with bound roots or, in other words, between lexemes and non-lexemes. Bound roots bear core meanings, most of which were borrowed from other languages, that are actually free in the source language but must be bound in English (e.g. *-mit* in *submit*, *commit*, *omit*, *remit* and *admit* is borrowed from the Latin *mittere*, which means 'to send') (Brinton & Brinton, 2010, p. 85). The affixes, on the other hand, do not have core semantics and are necessarily bound to roots, but again in some languages (e.g. Native American languages), affixes might bear meaning just like bound roots and they are distinguished in terms of their distribution in the language (e.g. *eat*, *floor*, *nape* and *knob* are affixes that have characteristics different from those of roots) (Lieber & Štekauer, 2009, p. 5).

In another definition, Bauer (2006, p. 485) clarified that the lexemes making up compounds can exist on their own:

Compounds are lexemes in the sense that they have – in appropriate word-classes – the ability and requirement to inflect just like lexemes which do not have a complex internal structure. Compounds are distinguished from other lexemes in that their internal structure shows two or more lexemic bases [...] – forms which in other places in the language inflect independently and can on their own act as the heads of relevant phrases

However, this criterion is challenged by compounds such as *watch maker*; the non-head can stand on its own whilst this is not the case with *maker*. For the same reason, the Danish form *cigarmager* 'cigar maker' and the

English form *warmonger* cannot fall under Bauer's definition of compounds (Padrosa-Trias, 2010, p. 99)⁹.

(c) *Lexicalism and the notion of word*: According to Dixon & Aikhenvald (2002), in linguistics, the notion of word also receives different views depending on the criterion regarded as primary – namely, whether, for example, it is a phonological word (i.e., compatible with the 'phonotactic structure of the language'), a prosodic word (i.e., compatible with the 'accentuation and the rhythm patterning of the language'), an orthographic word (i.e., based on writing conventions such as spaces), a syntactic word (i.e., based on its syntactic distribution), or a morphological word which is the main concern here.

Returning to the theory of lexicalism, it is also supplemented by the theory of lexical integrity; the lexicon is so sharply demarcated from syntax which has implications for the notion of word. The elements of words are impervious to syntactic operations; in other words, syntax cannot manipulate

⁹ *Watch maker, cigar maker, warmonger* are instances of synthetic compounds that are also controversial in terms of definition and status. Several definitions of synthetic compound are suggested in the literature; in one example, Marchand (1969, p. 15) defined it as "combinations whose second element are deverbal derivations from verbs which form a direct syntagma with determinant". The head element of a synthetic compound is complex and derived from a verb, and the non-head element must occur after the verb immediately in the corresponding verb phrase; for example, *truck driver* and *truck driving* 'drive a truck', *fast-acting* 'act fast', *moth-eaten* 'eaten by moth' and *pan-fried* 'fry in a pan' (Spencer, 1991, p. 324). According to Spencer (1991, p. 324), synthetic compounds in general are those ending with the suffix *-er* (e.g. *watchmaker, moneylender*). They may also include those based on gerunds and participles in *-ing* (e.g. *truck driving*). Forms of nominalisations can create synthetic compounds (e.g. *slum clearance*) (e.g. Selkirk, 1982; Sproat, 1985) or passive participles (e.g. *home-bred, moth-eaten, air-borne*) (e.g. Marchand, 1969), whilst Selkirk (1982) and Roeper & Siegel (1987) included compounds formed on adjectives (e.g. *machine readable*). However, the most agreed form of synthetic compounds are those ending with *-er*, gerund or participle *-ing* and passive participle.

the internal structure of words. Different proposals have been suggested; Lieber and Scalise (2006, p. 7) presented the following quotations, all of which agree on that sense of divide:

(13) Generalised Lexicalist Hypothesis

No syntactic rule can refer to elements of morphological structure.

(Lapointe 1980, p. 8)

(14) Word Structure Autonomy Condition

No deletion or movement transformations may involve categories of both W structure and S structure.

(Selkirk 1982, p. 70)

(15) The Atomicity Thesis

Words are “atomic” at the level of phrasal syntax and phrasal semantics. The words have “features,” or properties, but these features have no structure, and the relation of these features to the internal composition of the word cannot be relevant in syntax – this is the thesis of the atomicity of words, or the lexical integrity hypothesis, or the strong lexicalist hypothesis (as in Lapointe 1980), or a version of the lexicalist hypothesis of Chomsky (1970), Williams (1978, 1978a), and numerous others.

(Di Sciullo & Williams 1987, p. 49)

As previously stated, the problem with the definition is also related to a more controversial case; some compounds show characteristics of phrases that cause confusion in their real position, a compound or a phrase. Many compounds can be recognised easily due to their adherence to the criteria of words, but data also suggest that deviations from the expected behaviour do occur. The issue has been discussed widely in the literature, and several criteria have been proposed, none of which has received consensus. Spencer (2000, p. 313) pointed out that ‘the distinction between compounding and phrase formation represents one of the more vexed problems in

morphological theory'. In the following sections, I will discuss a number of criteria employed to distinguish between both constructions, none of which is without exceptions.

1.1.2 Phonological criterion: stress

Phrasal and lexical concatenations have traditionally been distinguished by the placement of stress; a phrase has an end stress as in *salty water*, whereas a compound has a fore stress as in *salt water* (Olsen, 2000). Chomsky & Halle (1968, p. 17) attributed the difference in stress pattern to syntactic phrases being controlled by the nuclear stress rule (NSR), whilst compounds are subject to the compound stress rule (CSR). Chomsky & Halle (1968), as well as Marchand (1969) and Liberman & Sproat (1992), maintained that a noun-noun sequence with a right-hand stress is not a compound but a phrase. Liberman & Prince (1977, p. 257) predicted the following:

(16) In a configuration [cA Bc]:

- a. **NSR (Nuclear Stress Rule):** If C is a phrasal category, B is strong.
- b. **CSR (Compound Stress Rule):** If C is a lexical category, B is strong if it branches.

According to such rules, all NN constructions having a final stress are phrases. For example:

- (17) a. Bill went to an [NP important [N PARTY]]
b. Bill was wearing a [NP black [N SUIT]]

All NN constructions having fore-stress are predicted to be compounds, for example:

- (18) a. Bill went to a [NP [N BEACH party]]
 b. Bill was wearing a [NP [N WET suit]]

If a compound consists of more than two constituents (i.e. NNNs), the CSR in that case assigns two stress patterns according to the manner of its branching as in (19):

- (19) a. [[MONster-movie] marquee]
 b. [childhood [choLEsterol disorder]]
 ((17), (18) & (19) are taken from Olsen, 2000, pp. 57-58)

If the right constituent does not branch (19a) (i.e. [NN]N), stress is assigned to the leftmost element of the left-branching element (i.e. [ṄNN]N), but if it is a right-branching (19b) (i.e. N[NN]), the CSR assigns stress to its left-most noun (i.e. N[ṄNN]).

Restricting the discussion to NNs only¹⁰, the stress criterion as described above seems ideal to draw the distinction, but unfortunately cannot be upheld in reality. The end-stress pattern for phrases is systematic (although not always); however, this does not mean that all end-stressed NNs are phrases (Giegerich, 2009c, 2004; Plag, Kunter, Lappe, & Braun, 2008; Plag, 2003; Olsen, 2000), especially if the semantics of two constructions having different stress placement is similar. In other words, there is no good reason to say that, for example, *Madison Avenue* is a phrase whilst *Mádison Street* is a word based merely on the difference in their stress pattern; both

¹⁰ The generalisation made by the CSR rule about NNN compounds was questioned by Giegerich (2009c). He provided data in which stress on such constructions does not always abide by the CSR rule (e.g. the rule [NN]N is violated by *living room táble*; the rule N[NN] is violated by *gráin store-room*). In fact, there are another six types of predictable stress patterns found on both N[NN] and [NN]N compounds (for detailed discussion on NNN compounds, see Giegerich, 2009c).

are N-N consequences, having similar semantics, and right-headed (Giegerich, 2004, p. 10; Plag, 2003, p. 139).

A recognisable number of cases where variability in the stress pattern of compounds has proved that stress assignment should not be relied upon. In the following examples, N-N constructions argued to be compounds exhibit a stress pattern that deviates from CSR:

- | | | | |
|------|----------------------|-------------------|------------------|
| (20) | geologist-astrónomer | apple píe | scholar-áctivist |
| | apricot crúmble | Michigan hóspital | Madison Ávenue |
| | Boston márathon | Penny Láne | summer níght |
| | aluminum fóil | spring bréak | silk tíe |
- (Plag et al., 2008, p. 761)

There is also another argument that end-stressed compounds – thought to be exceptional – would in fact be systematic. Plag (2003, pp. 138–139) and Olsen (2000, pp. 61–62) argued that the difference in stress pattern in compounds is associated with the semantic relationship between the elements of the construction. A compound receives an end-stress in five cases (examples from Olsen, 2000, pp. 61–62):

- i. Copulative compounds; both elements of a compound refer to the same entity (e.g. *geologist-aSTROnomer*, *owner-Occupier*, *host-MEDiator*, *lawyer Father*).
- ii. Compounds whose non-head denotes a place, i.e. a ‘locative modifier’ (e.g. *hotel KItchen*, *neighbourhood REstaurant*, *corner TAbLe*, *car DOOR*).
- iii. Compounds whose non-head is temporal (e.g. *spring SHOWers*, *may FLOWers*, *Sunday DRIVE*, *winter TERM*, *summar NIGHT*).

iv. Compounds in which the relationship between their members is implicitly interpreted as 'made of' (e.g. *glass WInDow, wool COAT, paper BAG, lead PENcil, silk TIE*). Plag (2003, p. 139) added when it is also interpreted as 'created by' (e.g. *Shakespeare SOppet, Mahler SYMphony*).

v. Compounds in which the relationship between their members is predicative (e.g. *surprise enCOUNter, giant TElescope, senior SCientist, child Actor, student RAdical*).

Nevertheless, there are still gaps in the analysis recognised by Plag himself: (a) there is still the need to know about all the types of semantic relationships that can give a comprehensive account for the end stress behaviour in compounds and (b) this analysis does not explain why there exist two compounds having the same semantic relationship, but a different stress pattern; as just mentioned, *N-street* constructions have a fore-stressed pattern (e.g. *Óxford Street, Máin Street, Fóurth Street*), whereas *N-Avenue* constructions have an end-stressed pattern (e.g. *Madison Ávenue*).

Giegerich (2004, p. 14) discussed the effect of lexicalisation on the variability of the stress pattern in compounds. Lexicalisation is a gradual process; a phrasal construction does not become a member of the lexicon and acquire the characteristics of a lexical item abruptly. A compound, for example, might originally be a noun phrase that enters into the lexicon, preserving its syntactic characteristics such as stress placement, and with the

passing of time alongside other factors such as frequency of usage, this construction starts to lose some of its characteristics, a process that differs from one speaker to another. A well-known example is *ice-cream*, which displays either a fore- or end-stress pattern. Giegerich (2004, p. 14) pointed out that “[i]t is plausible therefore to expect a phrase that has entered the lexicon, say *ice 'cream* in time - for some speakers perhaps faster than for others - to lose its exception feature and become *'ice-cream*”. However, lexicalisation cannot account for all fore-stressed cases. *'Thistle oil* and *avo'cado oil* are fore-stressed recent coinages, and this rules out the effect of lexicalisation. Giegerich (2004, p. 20) speculated that the analogical effect might also be responsible for stress assignment; in other words, some newly coined compounds acquire their stress patterns in analogy to constructions that already exist and share similar semantics. *'Thistle oil* and *avo'cado oil* have their leftmost stress in analogy to fore-stressed compounds such as *peanut oil* and *corn oil*. Analogical effect might also be a plausible account for the fore-stressed N-street and the end-stressed N-avenue and N-road. The problem with this solution, however, is that it leaves an unanswered question about the difference between the process of acquiring fore-stress through analogy and that through the productive process of compound formation (Giegerich, 2004, p. 20).

To sum up, the variability of stress pattern on compounds, especially on compounds having similar semantics, is still inexplicable. Stress cannot be used as a reliable criterion of distinctiveness between compounds and

phrases.

1.1.3 Syntactic criteria

The lexical integrity hypothesis holds that the internal structure of the word is immune to any syntactic operation due to the independence of morphology from syntax (Chomsky, 1970) and, as a consequence, compounds can be distinguished from phrases by employing syntactic tests; an N-N sequence is a word if such tests do not apply (Bauer, 1998).

However, we will see in the following sections that a number of syntactic tests failed to draw a clear-cut distinction between a lexical and syntactic concatenation.

(a) *Compounds as anaphoric islands*: One test related to the syntactic isolation of the first element is that it should not antecede an anaphor¹¹.

(21) Hunters of animals tend to like them. [them = animals]

(22) ***Animal** hunters tend to like **them**.

(Ward, Sproat, & McKoon, 1991, p. 439)

However, this test also faces problematic examples such as those below:

(23) What sharply distinguishes Chomskyan practice from that of his structuralist forebears is ...

(24) So, I hear you're a real cat-lover. How many do you have now?

(25) If you're a small business owner, or interested in starting one ...

(Bauer, 1998, p. 72)

¹¹ See footnote 4 for the definition of the term 'anaphor'.

The example (23) is perfectly grammatical even though *his* is used to refer to the base of the adjective *Chomskyan*, while in (24) & (25) pragmatics is said to play a role against the anaphoric-island constraint.

(b) *Coordination with one*: Another test of syntacticity is the possibility of a construction to coordinate with *one*, so we expect that *one* cannot be used to refer to either the first or second element of a compound (Bauer, 1998; Spencer, 2000); for example, **a white-board and a black one*, **a watchmaker and a clock one*, **a butterfly-net and a mosquito one*, in contrast with syntactic construction in which *pro-one* is very common (e.g. *a white board and a black one*, *a beautiful picture and an ugly one*, *a steel bridge and a stone one*) (Giegerich, 2005, p. 46).

Just as with the previous criterion, this syntactic feature would be available for some compounds as well. Bauer (1998, p. 77) listed some examples of compounds coordinated with *one*:

- (26) a. There were mills dotted all over the landscape, *watermills* and *wind ones*.
b. Do you want *a table-spoon* or *a tea one*?
c. He wanted *a riding horse*, as neither of the *carriage ones* would suffice.
d. I wanted *a sewing machine*, but he bought *a knitting one*.

These exceptional cases were thought to be rare and their acceptability might be gradient, as Bauer's corpus study also showed only seven instances where compounds are coordinated with *one*, all of which are end-stressed, so apparently behaving like syntactic constructions. However, consider the example *Do you have a medical appointment or a dental one?* (Giegerich, 2005, p.

48); the head noun is substituted with *one*, but the N-N sequence is fore-stressed, behaving like other lexical constructions.

(c) *Coordination between the first or second element of two N-N constructions*: Similarly, Payne & Huddleston (2002, pp. 448-450) maintained that amenability of an N-N sequence to coordination is a reliable test of its syntacticity:

- (27) New car
a. [new and used] cars
b. new [buses and cars]
- (28) Ice-cream
a. *[ice- and custard] creams
b. *ice-[lollies and creams]
c. *[two ice- and ten custard-] creams

Examples in (27) & (28) conform to the sharp divide between lexicon and syntax; *new car* consists of two words, both of which can be coordinated. In contrast, *ice-cream* consists of two constituents, which do not allow for sub-lexical coordination. Similarly, it is not acceptable to say, for example, **buttercup and saucer* or *bread and buttercup*, in comparison with noun phrases like *steel and iron bars*, *steel bars and weights* (Bauer, 1998, p. 74).

Bell (2012, p. 64), however, argued that sub-lexical coordination in morphologically complex words can be ‘easily’ demonstrated, especially in the case of ‘neoclassical prefixes and words’:

- (29) a... all dealing with a mixture of **over and underconstrained** problems
b.... one of the best known officers of the **pre and postwar** RAF...
c.... the problems of **inter and intraobserver** variation...

Payne & Huddleston (2002) claimed that sub-lexical coordination is

not possible for compounds even if the elements to be coordinated are semantically related, as they demonstrated with the examples below:

- (30) a. sunrise ~ sunset *[the sunrise and set] were both magnificent
b. backache ~ toothache *[I'm suffering from [back and toothache]
c. swimwear ~ sportswear *This is [a swim and sportswear]
(Payne & Huddleston, 2002, p. 450)

By contrast, Bauer (1998, p. 74) argued that coordination is possible for compounding under some semantic restrictions. One restriction is that the elements coordinated should be semantically governed in the sense that the elements coordinated should be in the same domain (e.g. *cat and dog shows* vs. *?antique and dog shows*), (ii) if the expression is lexicalised, it would be difficult to be coordinated with most of the items (e.g. **buttercup and saucer* vs. *honey and buttercups*) and (iii) the elements coordinated should have a parallel relationship (e.g. *wind- and watermills* vs. *?wind- and flour-mills*). This kind of coordination is called 'natural coordination', unlike 'accidental coordination' between semantically unrelated words (Bell, 2012; Dalrymple & Nikolaeva, 2006).

In general, the diagnostic test of coordination is not as reliable as otherwise widely accepted to draw a sharp divide between lexical and syntactic N-N sequences.

(d) Modification of the elements of a compound: Conforming to LIH, elements of a compound should not be modified independently. The criterion of inseparability, as named by Lieber (1992a, 1992b, p. 13), prohibits a compound from having an item between its elements (e.g. **black heavy*

board), whilst this is normal for phrases. Lieber claimed that this criterion is more reliable in comparison with other criteria¹².

In the same vein, the first element of a compound should not be modified independently. An example like *broad river-bed* is fine since the adjective modifies the whole compound (i.e. *a broad bed for a river*: broad [river bed]), while an example like *?swollen river-bed* is probably ungrammatical as it seems that the adjective modifies the first element *river* (i.e. *?a swollen river*) (Bauer, 1998, p. 73)¹³. However, the prohibition against this kind of sub-modification for compounds can be challenged. There are counterexamples in which the susceptibility of the first element for modification is possible, thereby producing phrases embedded in compounds (i.e. [[NN] N]). In the examples below, two interpretations are possible; one is associated with the possibility that the adjectives modify the whole compounds (i.e. [N [NN]]) (31a), and the other is associated with the possibility that the adjectives modify the non-head nouns only (i.e. [[NN] N]) (31b) (Bauer, 1998, p. 73)::

- | | |
|-----------------------------|----------------------------|
| (31) a. Chinese jade figure | (i) Chinese [jade figure] |
| | (ii) [Chinese jade] figure |
| b. Swedish steel blade | (i) Swedish [steel blade] |
| | (ii) [Swedish steel] blade |

There are also constructions with only one interpretation, in which the

¹² Lieber's main argument (1992b) is that morphology as an independent component should be eliminated.

¹³ According to Bauer (1998, p. 73), *swollen river-bed* is an attested form, so he questioned whether such a construction was produced as a kind of 'rule-breaking creativity'.

non-head in a compound is adjectively modified:

- (32) a. [public lending] right b. [light-rail] system
c. [big-ticket] items d. [Serious Fraud] Office
(Bauer, 1998, p. 73)

Examples such as those in (31) and (32) further call into question the theory of the sharp divide between syntax and lexicon that prohibits phrases from appearing inside compounds (e.g., **Kind of computer you can put in a small suitcase manufacturer*; Spencer, 2000, p. 313) in accordance with Botha's constraint (1981, p. 18) in (33) below¹⁴:

- (33) No Phrase Constraint**
Morphologically, complex words cannot be formed (by WFRs) on the basis of syntactic phrases.

In sum, the question of how we distinguish compounds from phrases proves difficult to answer due to the sharp lexicon–syntax divide that implies categorisation. Giegerich (2009b, p. 1) states:

The syntax-lexicon divide, in the form of the theory's Lexical Integrity Principle, proves more difficult to verify: a number of mismatches between the syntactic and the phonological as well as the semantic behaviour of compounds falsify the assumption of a sharp divide between modules.

Categorisation in morphology will only allow compounds with pure lexical characteristics and fully lexicalised compounds to be classified as words; however, lexicalisation itself is a gradient phenomenon. According to Trousdale (2008, p. 164), the process of 'lexicalization' has three stages. First, the semi-fossilised stage at which the productivity of syntactic expression is

¹⁴ Phrasal compounds will be discussed in detail in chapter II (5.3.3).

gradually decreased; for example, *curry favour with* does not accept manipulation in the structure **Favour was curried with*). The second stage is marked when the phrase changes into a partially idiosyncratic complex form (e.g., the OE forms *wīs* and *dōm* were united into one complex form *wisdom*, where the second element has changed into a suffix). The third stage is marked when the semi-fossilised phrase or the partially idiosyncratic complex form changes into a complete fossilised form (e.g., *lord* is an unanalysable form of the OE compound form *hlafweard* 'loaf keeper'). It is not necessary for a lexicalised item to undergo the three stages; it might be entirely lexicalised without going through the three stages, it might stop at the first stage, or it might go through the second stage without passing through the first stage. What can this tell us about lexicalism – is it false and do we only need a syntactic engine for word and phrases? As previously discussed – and as will be discussed further in the following section – lexical and syntactic constructions are different in terms of their internal structures and rules of formation, implying that two independent systems for morphology and syntax are indispensable. Giegerich (2005) argues that phenomena with hybrid behaviour, such as compounds, necessitate a theory of grammar that allows for modular overlap, which will “facilitate simpler analyses for a number of other constructions known to be close to the interface of the lexicon and the syntax” (p. 45).

1.2 Rejection of Lexicalism

The theory of lexicalism has been rejected by a number of scholars who developed a more modern theory: distributed morphology (DM) (Halle & Marantz, 1993; Harley, 2009; Harley & Noyer, 1999; Marantz, 1997, 2001, 2007). DM is a more extreme theory than earlier syntactic theories as it demolishes not only morphology as an independent component, but also the lexicon. Proponents of the theory deny any special status about the word (e.g. special phonological and morphological rules, the feature of idiosyncrasy), which has led to the assumption that there must be a special place for words. They have claimed that the generation of well-formed words and phrases occurs only in syntax as a sole, but capable, component. In his paper, Marantz (1997, p. 202) said, "This paper brings the reader the following news: lexicalism is dead, deceased, demised, no more, passed on. [... DM is] the alternative that allows us to dump lexicalism once and for all".

In lexicalism, the requirements of a word should be satisfied so that they can generate a well-formed base for syntactic structure; for example, a word like *destroy* should be assigned an agent subject (e.g. *the barbarians*) and a patient object (e.g. *the city*) so as to form an expression like *the barbarians destroyed the city* (Harley & Noyer, 2000, p. 351). This view is radically changed within DM; basically, the features of words can be represented in terminal nodes and manipulated by syntax before being sent to the phonological form for realisation as vocabulary items. We will see in the following section how the arguments in synthetic compounds can be

satisfied. DM has also dealt with compounding and the problem of the regular plural within compounds. I will first review the theory and mention as an example how compounding is processed within a syntactic engine; this will be followed by a comparison of DM and lexicalism.

1.2.1 Distributed morphology

The term distributed morphology is derived from the theory that the lexicon does not exist and its functions should be distributed among other components of grammar, more specifically, syntax and phonology (Embick & Noyer, 2007). Marantz (1997, p. 203) stated, “Distributional Morphology explodes the Lexicon and includes a number of distributed, non-computational lists as lexicon replacements”. Three lists are proposed as replacements for the lexicon (Embick & Noyer, 2007, p. 301):

List 1: ‘The Syntactic Terminal’: These comprise two kinds: abstract morphemes and roots.

List 2: ‘The Vocabulary’: This contains the list of vocabulary items which are competing for the phonological realisations at Phonological Form PF; the winning item is the one whose features do not conflict with the features of the terminal node for which it competes.

List 3: ‘The Encyclopaedia’: This list accounts for the lexicalisation of some roots (e.g. $\sqrt{\text{MOUSE}}$, ‘a computer pointing device’) and syntactic constructions (e.g. *kick the bucket*).

A model of this system is illustrated in Figure 1:

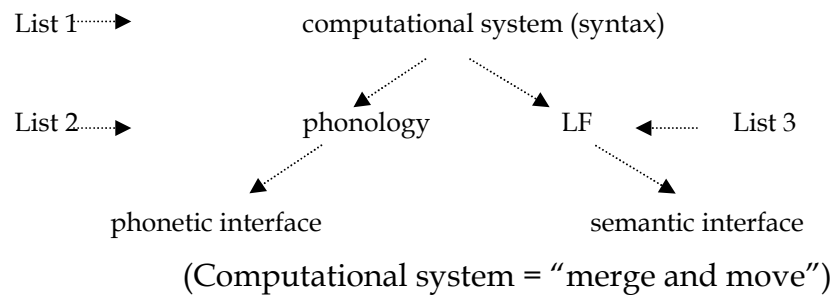

Figure 1. Structure of grammar in DM (Marantz, 1997, p. 205)

As shown in Figure 1, the generative system of grammar consists of three sub-systems:

a. Computational system (syntax): Basically, this system supplies the syntactic rules to generate hierarchal syntactic structures from two kinds of elements that make up terminal nodes, abstract morphemes and roots. The syntactic operations *merge* and *move* manipulate the abstract features to create an appropriate tree structure; the outcome is a sentence structure without phonological content, into which the ‘pieces of words’ are inserted. Some aspects of words are also generated in this system by operations such as merge and move (e.g. head movement).

‘Syntactic hierarchical structure all the way down’ is one of the key features of DM: the kind of relationship between elements that form words does not differ from the kind of relationship between words that form phrases and sentences (Halle & Marantz, 1993), a view contradictory of the most important principles of lexicalism that Katamba (2004, p. 5) described as ‘radical’. According to this thinking, *dogs of war* and *wardogs* are syntactic structures, but the difference lies in the morphological processes involved

and also the vocabulary items realising them; for *wardogs*, the syntactic structure is finally spelled out as one complex word, while *dogs of war* is spelled out as two words separated by the preposition *of* (Siddiqi, 2006, p. 20)¹⁵.

The terminal nodes are of two kinds: abstract morphemes and roots (Embick & Noyer, 2007):

a. Abstract morphemes: a bundle of universal non-phonetic features that make up terminal nodes; features such as gender, person, tense, case and number form the agreement terminal node.

b. Roots: language-specific features of sound and meaning but devoid of grammatical categories. Roots are symbolised by \surd : \surd CAT, \surd OX and \surd SIT.

The distinction between abstract morphemes and roots reflects the distinction between functional and lexical categories in traditional generative theories. Moreover, roots and abstract morphemes are memorized; for abstract morphemes (e.g. number, tense), language speakers innately recognise these features, while they memorise roots as 'bare' items. The list of roots differs from one speaker to another; it is 'expandable', which means that new items can be added to the list.

¹⁵ Another example is the word *grammaticalization*. DM holds that it is a noun phrase which is decomposed into:

- a. The nominalising head *-ation* + the verb phrase *grammaticalise*
- b. The verbalising head *-ise* + the adjective phrase *grammatical*
- c. The adjectival head *-cal* + the root *gramm-*

However, the nature of the vocabulary items realising the functional heads is affixal and, accordingly, the spell-out of these complex features along with the root is a complex word (Siddiqi, 2006, p. 20).

Since a root does not bear a lexical category, it cannot appear on its own unless it merges with a 'category-creating terminal node' (e.g. n° = noun (functional category), a° = adjective (functional category), or v° = verb (functional category)):

(34) Categorisation Assumption

Roots cannot appear without being *categorised*; roots are categorised by combining with category-defining functional heads.

(Embick & Noyer, 2007, p. 296)

Category-creating terminal nodes have semantic content. As Harley (2009, p. 132) illustrated, v° can convey the meaning of "CAUSE as in *clarify* (tr), 'cause to be clear', BE as in *fear*, 'be afraid of', BECOME as in *grow*, 'become grown' and DO as in *dance*, 'do a dance'".

The root also can be merged with more than one feature-creating terminal node. For example, the root of *pennilessness* undergoes three syntactic merge operations; it merges with the creating features nodes n° and a° , and again with n° (Harley, 2009, p. 132):

(35) [[[[*penni*] v°] n]-less] a ness] n

b. Phonological sub-system: Two other key features are involved in this sub-system of DM: late insertion and underspecification. Regarding late insertion, the morphological features manipulated by syntax have no phonological content. At the stage of spell-out, it is assumed that all syntactic processes have completed, so the terminal nodes comprising the manipulated features are ready to acquire phonology, which is supplied by

vocabulary (i.e. vocabulary items) by the mechanism of vocabulary insertion (VI), defined in (36) below.

(36) Vocabulary Insertion

The mechanism supplying phonological features to the abstract morphemes.

(Embick & Noyer, 2007, p. 297)

For example, the vocabulary item *-s /z/* is inserted as an overt inflection to realise a terminal node associated with three features: present, singular and third person (Siddiqi, 2006, p. 19).

At the stage of vocabulary insertion, a number of vocabulary items might compete for realisation of the same terminal node. The selection of an item depends on the compatibility of its features with most of the features of the terminal node. For example, the items *am, is, are, was, were* and *be* compete for the realisation of a terminal node carrying the features [present], [singular], [first person]; obviously, *am* is the winning candidate since all of its features match with the features of the terminal node. An item like *are* fails in this competition because it is only specified for the feature [present]; it appears in four different environments: first-person plural present tense, second-person plural present, second-person singular present and third-person plural present – all of which share the present tense feature (Siddiqi, 2006, p. 30).

As far as compounding is concerned, Harley (2009) proposed that all types of compounds are formed by the operation merge in syntax proper. For synthetic compounds such as *truck driver*, (i) the root \sqrt{TRUCK} merges with a

nominalising head n° first; (ii) it then merges with and incorporates into the root \sqrt{DRIVE} , creating $[[[\sqrt{TRUCK}]_{\sqrt{n}}]_{np} \sqrt{DRIVE}]_{\sqrt{p}}$; (iii) \sqrt{DRIVE} merges with the nominalising head $-er$ and incorporates into it by head-movement, creating the structure $[[[\sqrt{TRUCK}]_{\sqrt{n}}]_{np} \sqrt{DRIVE}]_{\sqrt{p}} n]_{np}$; and (iv) finally, this abstract structure is filled with vocabulary items at the stage of spell-out. The tree structure of *truck driver* is illustrated in (37)

(37) Tree structure of *truck driver*

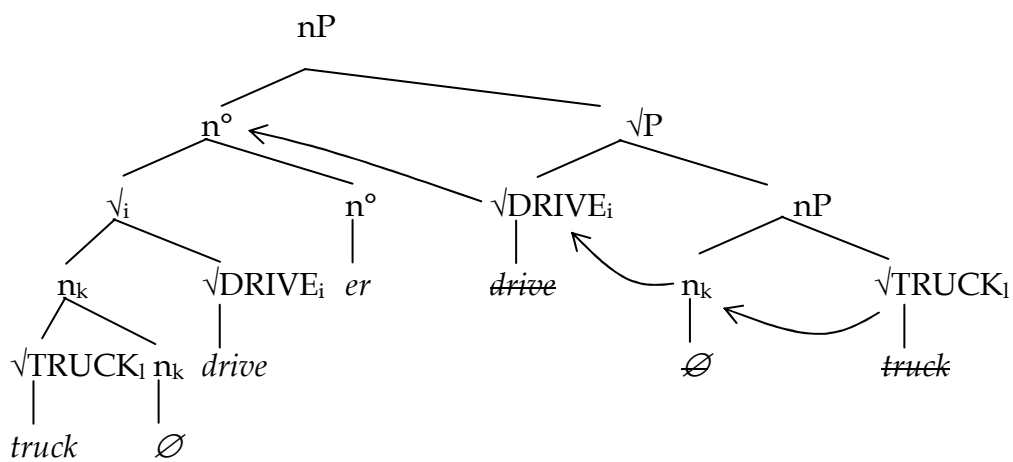

(Harley, 2009, p. 136)

Root compounds have a similar structure despite the relationship between the head and the non-head in the root and synthetic compound being different. In the case of the synthetic compound, the semantic relationship between the head and the non-head is ‘unambiguous’; *truck driver* is a *driver of a truck*¹⁶, whereas it could be ambiguous in the case of root compounds (e.g. *nurse shoes* vs. *alligator shoes*), and here Harley suggested that the semantic sub-system is responsible for providing a plausible

¹⁶ In this case, Lieber (2004, p. 60), however, suggested that synthetic compounds might not be fully transparent; for instance, a *truck driver* would plausibly refer to a *driver with a picture of a truck on his shirt*.

association between the incorporated noun and the head noun; for example, “nurse shoes are [shoes [(for) nurses]] whilst alligator shoes are [shoes [(of) alligator (skin)]]” (p. 139). For *nurse shoes*, as diagrammed in (38), \sqrt{NURSE} merges with a nominalising head n° , forming the structure $[P[n[\sqrt{NURSE}]\nu]_{np}]$, which then merges with and incorporates into the root \sqrt{SHOE} , before it merges with the nominalising head n° and head moves to it. The final structure is realised by vocabulary insertion in the phonological sub-system.

(38) Tree structure of *nurse shoes*

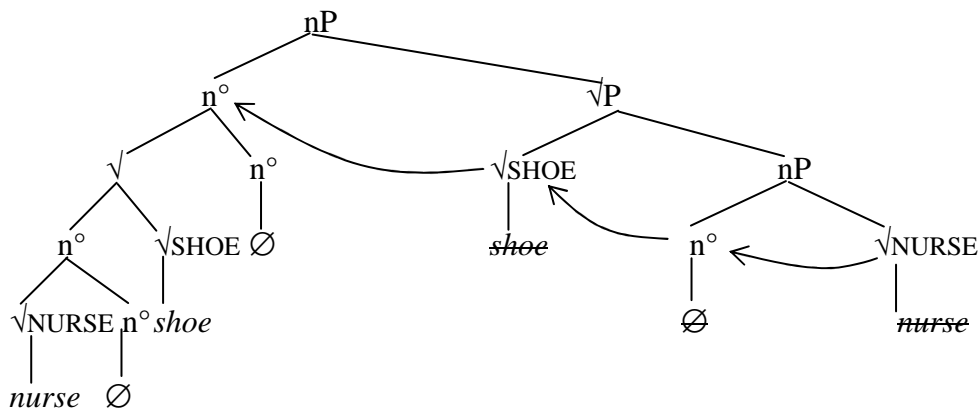

(Harley, 2009, p. 140)

1.2.2 Distributed morphology versus lexicalism

Williams (2007) criticised Marantz’ claim (1997) that DM should be a better substitute for lexicalism. His call for ‘dumping’ lexicalism should be understood knowing that DM has distinctive features, tackling the empirical problems associated with lexicalism and, as Lieber & Scalise (2006) added, providing a better account for the interaction between morphology and

syntax. In fact, DM encounters the classic problem resulting from refuting both the lexicon and the independent system of morphology. I will discuss some of these problems briefly, focusing on the problem of the appearance of the regular plural inside compounds.

First, Williams (2007) commented on Harley & Noyer's claim (1999) that the architecture of grammar in DM is distinguished by its three features: late insertion, underspecification and syntactic hierarchical structure all the way down. In fact, the first two features are not so distinctive because they were proposed in different theories, including lexicalism. For example, the notion of late insertion was discussed long ago within Generative Semantics, and also by Den Besten (as cited in Williams, 2007, p. 358) in a later version of Transformational Grammar (Cann, PC., 2014). Similarly, underspecification was a very old notion employed by Williams (1981) for the modern treatment of inflection.¹⁷

The third property in fact conflicts with the heart of lexicalism; words and phrases have the same syntactic structure and as such they are subject to the same rules and operations. Ackema & Neeleman (2004) demonstrated in

¹⁷ Williams (2007, p. 358) also noted three other notions incorporated into DM, none of which is distinctive: (i) the notion of piece-based words, referring to the theory that words are made of morphemes; (ii) competition, which is when roots compete for vocabulary insertion in a terminal node carrying a bundle of features, and the winner is the one that is compatible with the most features (e.g. $\sqrt{\text{BAD}}$ competes to be realised as either *bad* or *worse* under a terminal node containing the comparative feature; Harley & Noyer, 2000, p. 23); and (iii) impoverishment, which is the operation of deletion of some features of morphemes before being sent to the PF, which will affect the insertion of the vocabulary item requiring those features, leading to the insertion of a less specified item. The last two notions were previously mentioned in Williams (1981). The notion of competition can also be understood from Aronoff's blocking (1976) and Kiparsky's elsewhere principles (1982).

the examples shown below that the formation of words by syntactic movements faces the problem of stranding,¹⁸ which is impossible for compounding and derivation. It is ungrammatical to extract a non-head of a complex word from a complement to form a compound word as in (39- 41bs) and also to form derivative nouns as in (42) (Ackema & Neeleman, 2004, p. 19):

- (39) a. the centre [of [a [prosperous medieval [city [in Northern Italy]]]]]
 b. *the [city_i centre] [of [a [prosperous medieval [t_i [in Northern Italy]]]]]
- (40) a. to tend [to [a [luxurious [bar [in the West End]]]]]
 b. *to [bar_i tend] [to [a [luxurious [t_i [in the West End]]]]]
- (41) a. made [by [the strong [hand [of a blacksmith]]]]
 b. *[hand_i made] [by [the [strong [t_i [of a blacksmith]]]]]
- (42) a. *[parent_i hood] [(of) [a [responsible [t_i [from Glasgow]]]]]
 b. *[wash_i able] [carefully [t_i [by dipping repeatedly in hot water]]]
 c. *[central_i ize] [more [t_i [to our arguments] [than we thought]]]

In (39-41bs) and also in (42), the stranded materials are not licensed by their traces.

Lieber & Scalise (2006, p. 20) pointed out that “proponents of DM are free to explicitly reject the LIH, but in doing so they must explain why the data for syntax/morphology interaction appears to be so limited”. In fact, according to Williams (2007), defenders of DM do not provide strong arguments for how a theory like DM is superior to lexicalism by addressing

¹⁸ To illustrate *stranding* in phrasal formation, a preposition, in a sentence like *they asked [to whom he was referring]*, can be separated from its complement by movement of the complement, *they asked who he was referring to*; in this case, the preposition is stranded (or orphaned) (Radford, 2004, p. 216).

empirical problems associated with lexicalism; rather, they are concerned with the idea that DM can reach the same conclusions as lexicalism (see, for example, Harley & Noyer, 2000; Marantz, 1997; Siddiqi, 2009). For example, Marantz (1997) claimed that differences between gerunds and derived nominals can be explained without the need for a generative component like lexicon: “When the roots are placed in a nominal environment, the result is a “nominalization”; when the roots are placed in a verbal environment, they become verbs” (p. 216).

The refutation of the lexicon has also been trouble for DM. The most important function of the lexicon is that of storage for lexicalised phrases and words. According to Williams (2007), in the lexicalist theory, an idiom such as *kick the bucket* is simply stored in the lexicon as a whole ‘die’. In DM, on the other hand, the situation is complicated; the Root \sqrt{KICK} is encoded with the special meaning ‘die’ if it is triggered by the syntactic context *the bucket*. Here, Marantz (1997, p. 12) suggested that the root with this particular context does not have a functional head (i.e. ‘the little verb *v*’) which assigns an agentive role to the subject. In other words, without that little *v*, the root along with its context will be idiomatic. For an example like *the shit hit the fan*, there is a subject and verb, but the whole structure is idiomatic because the subject here is non-agentive. Williams (2007, p. 361), however, argued that the subject might have an agentive role in idiomatic structures as in *the cat has got your tongue* ‘you’re speechless’, where *the cat* is ‘keeper of your

tongue', and in this case the little *v* does exist, which is supposedly a preventer to assigning the subject an agentive role.¹⁹

DM also faces the problem of inflections inside compounds. Harley (2009) proposed that all compounds regardless of type should have the same syntactic structure. However, Siddiqi (2006) noted that DM fails to account for the dichotomy between regular and irregular plurals in the examples below:

- | | | |
|------|------------------|-------------------|
| (43) | a. lice-infested | b. *rats-infested |
| | feet-first | *heads-first |
| | systems analysis | *logs-cutter |
- (Siddiqi, 2006, p. 84)

If these compounds undergo similar operations, it is not clear why regular plurals inside compounds are not accepted as irregular plurals. With the existence of the lexicon, the explanation is straightforward; irregular plurals and pluralia tantum are listed in the lexicon, so they are available for a productive rule like compounding (see § 2.1 for detailed discussion). A similar explanation is obviously not available for DM since the generative lexicon does not exist. As a way out of the problem, Siddiqi (2006) maintained the basic claim that all compounds go through the same syntactic structure, but they diverge at the stage of readjustment rules where morphological merger occurs. Siddiqi proposed that the incorporated noun and root of the head noun must be adjacent. For the acceptability of *lice-infested*, the root \sqrt{LICE} adjoins the nominalising head n° that also carries the

¹⁹ For more illustration of the problem of idioms within DM, see Williams (2007, pp. 359-361).

feature [plural]. As illustrated in the tree diagram below, *lice* and \sqrt{INFEST} are two adjacent heads so an incorporation merge is unproblematic:

(44) Lice-infested

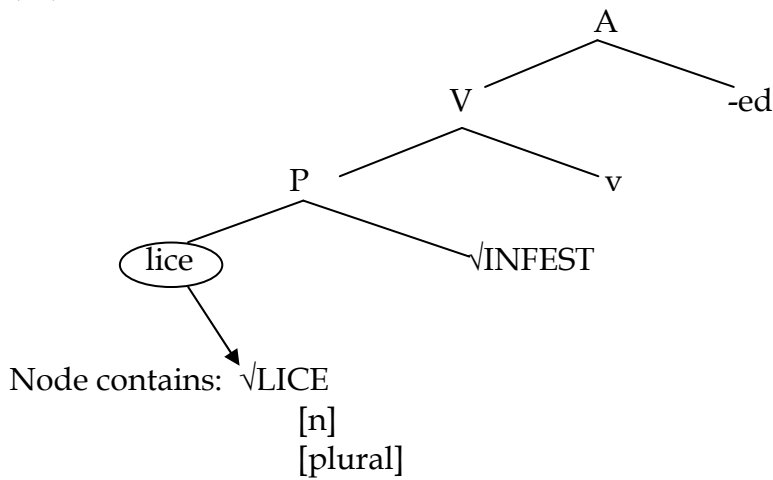

On the other hand, the noun *rats* is originally two vocabulary items (*rat + s*), and here as illustrated in the diagram below, \sqrt{INFEST} cannot merge with the head noun *rat* since *s* occupies a higher node.

(45) *Rats-infested

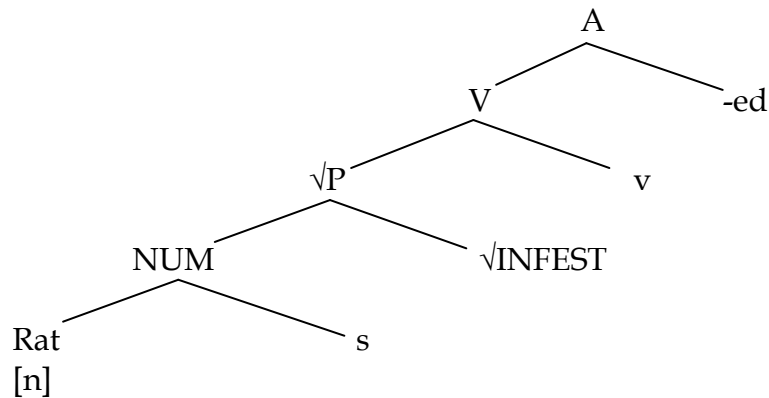

((44) & (45) are taken from Siddiqi, 2006, pp. 90-91)

Pluralia tantum inside compounds are given treatment similar to irregular plurals. *Admissions* does not originally consist of two vocabulary items; hence, it is an adjacent head *n* to \sqrt{OFFICE} .

Siddiqi's solution for the acceptability of irregular plurals and pluralia tantum and the unacceptability of regular plurals inside compounds demonstrates one of William's (2007) criticisms of DM; it aims to reach the same conclusions that lexical theories have reached depending solely on the syntactic component rather than providing solutions for empirical problems. As will be discussed in (§ 2.1), level ordering accounts for the dichotomy of plural inflections within compounds in terms of a stratified lexicon, but the important question that both theories should answer is why a compositional regular plural noun is sometimes allowed. A well-known example is *publications catalogue*; the relationship between *publication* and *publications* is transparent so it should not be attributed to idiosyncrasy. DM mispredicts the ill-formedness of *publications catalogue*; *publication* and *s* are two separate items, where *s* occupies a higher node, and in this case *publication* is not adjacent to *catalogue* so they should not be merged.

To sum up the previous discussions, an independent system of morphology is indispensable; lexicalism cannot be 'dumped'.

The lexical phonology and morphology (LPM) is a strong version of lexicalist hypothesis. In the following section, I will provide a detailed comparison between two versions of LPM: Affix-driven stratification and the base-driven stratification. The latter is the framework within which the problem of the regular plural inside compounds is approached.

2. LEXICAL STRATIFICATION MODELS

2.1 Level Ordering Theory

Most early theories of level ordering are based on the claim that the lexicon is stratified according to the distinction between two classes of affixation. In *The Sound Pattern of English* (SPE) (Chomsky & Halle, 1968), affixes were classified into two types: (i) Class I affixes (e.g. suffixes: *-ion, -ity, -y, -al, -ic, -ate, -ous, -ive*; prefixes: *re-, con-, de-, sub-, pre-, in-, en-, be-*) and (ii) Class II affixes (e.g. suffixes: *-ness, -less, -hood, -ful, -ly, -y, -like*; prefixes: *re-, sub-, un-, non-, de-, semi-, anti-*). The classification of these affixes is based on how they affect the host bases they attach to both phonologically and morphologically. Phonologically, Class I affixation is stress determining, causing a shift in the primary stress assignment of lexical items to which such affixes attach.

(46) **Class I suffixes:** *télégraph vs. telegraphy, elicit vs. élitátion, recóver vs. recòverablílity*

(Siegel, 1974, pp. 111-112)

Class I prefixes: *interdict* (rightward stress shift), *advocate* (leftward stress shift).²⁰

(Siegel, 1974, p. 115)

In contrast, Class II affixation is stress neutral to the host bases. However, Class II prefixes weaken the main stress on the word by attracting it to themselves (i.e. stress subordination), but yet are still stress neutral in

²⁰ Class I suffixes always cause a rightward shift in stress assignment whereas Class I prefixes can create a right- or leftward shift (see Siegel, 1974, pp. 111- 130, for a detailed discussion).

the sense that they do not cause stress retraction off the words. Class II suffixes, on the other hand, do not cause any kind of stress change (Siegel, 1974, 1979):

- (47) **a. Class II suffixes:** *hindrance, remembrance disastrous, burglar*
b. Class II prefixes: *monosyllable, metalanguage, subtreasurer*
(a) & (b) taken from Siegel, 1974, pp. 113 & 132, respectively)

According to Siegel (1979, p. 147), the stress behaviour of Class II affixation supports the argument that words derived from it should be treated like compounds; “stress subordination in class II prefix-derived words is handled exactly like stress subordination in compounds”²¹.

Allen (1978) also observed that Class I affixation might undergo other phonological processes, like nasal assimilation (e.g. *illegal/ *inlegal, irregular/ *inregular*), whereas Class II affixation cannot cause any nasal assimilation (e.g. *unlawful/ *ulllawful, unruly/ *urruly*) (Mohanana, 1982, p. 19).

As a consequence of the differences in the phonological behaviour of Class I and Class II affixation, in SPE Class I affixes are associated with a morpheme boundary + that allows for the cyclic application of stress rules²², while Class II affixes are associated with the word boundary # that blocks it:

²¹ Moreover, Class II prefixes can be coordinated (e.g. *mono- and tri-syllabic, hyper- and hypo-thyroid* just like some compounds such as *chocolate and vanilla pie*) unlike Class I prefixes (e.g. **ex- and se-cretions, * mono- or rhino-cerosus*) (Siegel, 1974, p. 147).

²² A cyclic stress assignment rule refers to the theory that stress assignment is applied after each morphological rule, like affixation or compounding, in a cyclic manner (Mohanana, 1982, p. 12). Cyclic phonology is a distinctive characteristic of lexical phonology.

- (48) **Class I suffixes:** +ion, +ity, +y, +al, +ic, +ate, +ous, +ive
Class I prefixes: re+, con+, de+, sub+, pre+, in+, en+, be+
Class II suffixes: #ness, #less, #hood, #ful, #ly, #y, #like
Class II prefixes: re#, sub#, un#, non#, de#, semi#, anti#
 (Spencer, 1991, p. 79)

Morphologically, Class I affixes attach to stems and words whereas Class II affixes attach only to words²³. The following examples are types of derived words from Class I and II affixation predicted in Siegel (1974, pp. 149-150):

- (49) a. [#pre+]P[stem]S#]W influx, deduce, advent, submit
 b. [#stem]S[+suf]Suf#]W vacate, fluid, optimize, legal
 c. [#pre+]P[#word#]W#]W inability, inequity, delimit, compassion
 d. [#pre#]P[#word#]W#]W paramedical, monosyllable, subhuman
 e. [#word#]W[+suf]Suf#]W legality, action, variant, limitation
 f. [#word#]W[#suf]Suf#]W kindness, peaceful, arrival, refusal

These observations of the phonological and morphological patterns of Class I and Class II affixation, extensively explained in Siegel (1974), have important consequences for the structure of the English lexicon; they constitute the core of the theory of lexical phonology and morphology that describes the interaction between morphology and stress assignment rules (e.g. Allen, 1978; Halle & Mohanan, 1985; Siegel, 1974). According to Kiparsky (1982), the theory of lexical phonology refers to the idea that phonological and morphological rules are applied in parallel and constrained by a level-ordered lexicon.

²³ With the exception of examples like *gruesome*, *winsome*, *fulsome*, *hapless* and *feckless*, in which Class II affixes attach to stems (Siegel, 1974, p. 149).

Siegel (1974) proposed that the lexicon is structured into two strata: stratum 1 consists of Class I affixation, stems and underived words, while stratum 2 is where Class II affixation takes place. Cyclic stress assignment rules occur between the two blocks, so they follow Class I affixation and precede Class II affixation²⁴. Siegel's proposal is known as the level-ordering hypothesis:

(50) Level-Ordering Hypothesis

- A. In English, Class I affixation precedes Class II affixation.
- B. The cyclic stress assignment rules follow Class I affixation and precede II affixation.

(Siegel, 1974, p. 152)

The hierarchy of levels, as Siegel argued, is necessary to account for the different behaviours that the two classes of affixes show both phonologically and morphologically, as previously discussed. The input of stratum 1 is Class I affixes, underived words and stems. The products of concatenation between affixes and words, or affixes and stems, as well as underived words will be sent to the block where the cyclic stress assignment rules take place. The output—Class I-stressed words and stressed underived words—will then serve as input for stratum 2 rules, where stressed Class II prefixes and unstressed Class II suffixes also constitute the input of stratum 2. Due to the sequential property of the rules, the output of stratum 2 will never be affected by the preceding phonological rules.

²⁴ The first level at which phonology has access to morphology is also called the cyclic level, while the second level is called the post-cyclic level (Mohan, 1982).

The morphological distinction between Class I and Class II affixation can also be maintained. Stratum 2 affixation can be derived from stratum 1 affixation, but not vice versa; for instance, *Darwin+ian#ism* is acceptable, whereas *Darwin#ism+ian* is not (Gordon, 1985, p. 74). This also explains why Class I affixes can attach to stems and words whereas Class II affixes attach to words only. A stratum 1 affix like *-ity* can attach to a stem like *prosper* (i.e. *prosperity*), whereas it is too late for a stratum 2 affix like *-ness* to be concatenated with it (**prosperness*) (Sproat, 1985, p. 18). The output of stratum 2 affixation will then be sent to syntax.

Allen (1978) extended Siegel's hypothesis, which became known as the extended level-ordering hypothesis. In addition to the two strata for Class I and Class II affixation separated by cyclic stress assignment rules, Allen assigned compounding a special stratum:

(51) Extended Ordering Hypothesis

Compound formation follows all rules of affixation, and the assignment of external word-boundaries to lexical items is ordered after affixation rules but before compounding

(Allen, 1978, p. 83)

The assignment of compounding to the third level predicts that compound words do not undergo phonological processes like Class II affixes (e.g. *houseboat*). The hypothesis also predicts that level 1 and level 2 affixation

do not occur outside compounds (e.g. **un-college-educated*, **un-factory-built*) (Allen, 1978, p. 66)²⁵.

The structure of the lexicon was further elaborated in Halle & Mohanan (1985), who proposed a four-stratum model²⁶: Class I affixation and irregular inflection are assigned to stratum 1; Class II affixation applies at stratum 2; stratum 3 is the site of compound formation; and stratum 4 is for regular inflections (i.e. regular plural, past tense, past participles of verbs). Halle & Mohanan's model also holds that the rules of phonology be assigned to specific strata and their applications be restricted to the strata to which they are assigned. The principles of the assignment of phonological rules are listed in (52)²⁷:

(52) Principles of Domain Assignment

- a) In the absence of counterevidence, assign the smallest number of strata as the domain of a rule.
- b) In the absence of counterevidence, assign the highest possible stratum as the domain of a rule (where "lowest" = stratum 1).

(Halle & Mohanan, 1985, p. 58)

²⁵ Allen (1978, p. 66), however, observed that *non-* can appear outside compounds (*non-college-educated*, *non-factory-built*), in contrast to *un-* which is associated with # boundary; Allen suggested that *non-* is a level 3 rule so it is allowed to apply to compounds.

²⁶ Halle & Mohanan's proposal that the structure of the lexicon is stratified into four is not claimed to be universal; their model of lexical stratification is specified for the English lexicon. Although the number of strata can vary, there should be at least two strata in any language: one for morphological operations and another for syntactic operations.

²⁷ Halle & Mohanan also proposed a fifth stratum for syntactic rules, called a post-lexical stratum. There might be languages where the rules of phonology are assigned to only the postlexical stratum. For English, however, Halle & Mohanan maintained that phonological rules are assigned to both lexical and postlexical strata; furthermore, some of these rules apply to more than one stratum (for a detailed discussion, see Halle & Mohanan, 1985, pp. 58-63).

To ensure that these phonological rules are applied correctly, each needs to be assigned to a separate stratum. This requirement has been used as justification for the division of the lexicon into four strata: strata 1, 3 & 4 are cyclic, while stratum 2 is non-cyclic (see Halle & Mohanan, 1985, pp. 59-62, for supportive evidence):

- (53) Stratum 1: Class I derivation, irregular inflection (*stress rules, shortening rules, s-voicing*)
 Stratum 2: Class II derivation (*velar softening, vowel shift, vowel reduction,*)
 Stratum 3: Compounding (*vowel tensing, stem-final lengthening*)
 Stratum 4: Regular inflection (*l-Resyllabification*)

As Allen (1978) and Siegel (1974) argued, the placement of Class I and Class II derivational affixes on two sequential strata can successfully encapsulate their differences. The general rule that the regular plural should not show up inside compounds justifies the separation between compounding and the regular inflection. The problem, however, revolves around the separation between Class II affixation and compounding (Allen, 1978; Siegel, 1974); derivational affixes do not appear outside native compounds, a generalisation that rules out well-formed compounds in (54) to which Class II affixes attach on their peripheries:

- (54) Adjectives: a. **un**-self-sufficient, **non**-weather-related
 b. turnover-**less**, painstaking-**ly**
- Nouns: a. **ex**-frogman, **non**-earthquake, **arch**-birdbrain
 b. laidback-**ness**, pickup-**ful**
- (Selkirk, 1982, p. 92)

The separation between compounding and Class II affixation in Halle & Mohanan's model is necessary for phonological reasons. Maintaining this interaction and avoiding any problem in the morphological distribution resulting from the separation requires a device that allows for compounding to feed back into Class II affixation. The loop device first suggested in Mohanan (1982, p. 35) "allows two adjacent strata to be inputs to each other":

- (55) Stratum 1: Class I derivation, irregular inflection
 ↖ Stratum 2: Class II derivation
 ↖ Stratum 3: Compounding
 ↖ Stratum 4: Regular inflection
- (Halle & Mohanan, 1985, p. 64)

Drawing on these previous models of stratification, Kiparsky (1982) also organised inflectional and derivational rules into a series of strata. Each stratum is associated with phonological rules to which are sent the products of word-formation processes of the same stratum. Kiparsky divided the English lexicon into three strata: stratum 1 includes the rules of Class I affixation, irregular inflections and pluralia tantum. This stratum is characterised by its idiosyncrasy that partially accounts for the low productivity of its rules. Stratum 2 includes the rules of Class II affixation and compounding. Its semantics are predictable, with some exceptions (e.g. the words *height* and *highness* are not synonyms; Bauer, 2005, p. 322), and accordingly this stratum is more productive than the previous one. Stratum 3 is the site of regular inflections. It is characterised by its full semantic uniformity and productivity. The lexicon is then followed by a postlexical stratum, where syntactic operations take place.

As with any other stratification models, application of the inflectional and derivational rules proceeds through the three strata; rules at a higher (or later) stratum cannot apply prior to another rule at a lower (or earlier) stratum.

Kiparsky formulated the following rule by which inflectional affixes are concatenated with their bases (p. 134):

- (56) Insert A in env. $[Y_Z]_X$
[Y_Z]= "subcategorisation frame" of A, X= "inherent categorical information"

Following from this, for an irregular formation process of *oxen*, which is a stratum 1 rule, /en/ must be inserted after the insertion of the noun *ox* in the subcategorisation frame as in (57):

- (57) Insert /en/ in env. $[OX_]_{\text{Noun, + Plural}}$

Regular plural nouns such as *boys* undergo a rule as in (58):

- (58) Insert /z/ in env. $[X_]_{\text{Noun, + Plural}}$

The application of inflectional and derivational affixation is constrained by a number of specific rules. The blocking effect refers to the idea that the application of a rule precludes the application of another; for example, the application of the suffix *-en* to the noun *ox* at stratum 1 to indicate plurality blocks the application of the regular suffix *-s* to the same noun at stratum 3, and this constraint accounts for grammaticality unacceptable forms such as *oxes* and *foots*. The blocking effect is, therefore, a consequence of the level-ordered morphology in the sense that the rule applied at a lower stratum blocks another rule applied at a higher stratum.

Kiparsky assumed that the former rule is a special rule, whereas the latter is a general rule. This also accounts for the productivity of rules that apply at higher levels; for example, irregular inflections (stratum 1) are special rules whose applicability is restricted, whereas the regular inflection *-s* (stratum 3) is a general rule whose applicability is less restricted.

The corollary principle of the elsewhere condition in (59) stipulates that the specific rule must apply before the general rule:

(59) Elsewhere Condition

Rules A, B in the same component apply disjunctively to a form \emptyset if and only if:

- i. The structural description of A (the special rule) properly includes the structural description of B (the general rule).
- ii. The result of applying A to \emptyset is distinct from the result of applying B to \emptyset .

In that case, A is applied first, and if it takes effect, then B is not applied.

(Kiparsky, 1982, pp. 316-137)

2.2 Suffixation is not Constrained by Affix-driven Restrictions

According to the previous discussion, the stratal constraint on affixation predicts the following neat generalisations:

- a. Class I affixes appear inside words derived from Class II affixation (e.g., *Darwin+ian#ism*).
- b. Class II affixes cannot appear inside words derived from Class I affixation (e.g., **Darwin#ism+ian*).

The theory, however, has been seriously challenged both theoretically and empirically by many instances of affixation that do not conform to level-

ordering generalisations that have ultimately led to its rejection. I will briefly survey these problems, and then discuss Fabb's alternative affix-driven restrictions, which is itself questionable. The discussion ends with the conclusion that affixation is not affix-driven restricted.

(a) *Class I affixes attach to Class II affixes*: Fabb (1988) noted that in *un#grammatical+ity* a Class I suffix *+ity* attaches to a word already prefixed with a Class II member *un#*. Strauss (1982, p. 697) suggested that the generalisation of affix ordering does not apply to the ordering of prefixes and suffixes with each other: "[T]he ordering restrictions do not hold between left- and right-adjoining elements, i.e. that prefixation and suffixation are independent of each other". There are indeed examples of derivations where Class I suffixes attach to class II suffixes; for example, it is evident that in words ending with *#ist+ic*, *#ment+al*, and *#abil+ity*, neutral-stress affixes (Class II) precede stress-shifting affixes (Class I) (Fabb, 1988, p. 527). This phenomenon highlights the duality of a substantial number of presumably Class II suffixes discussed below.

(b) *The dual membership of affixes*: as Class I and Class II affixes are strictly associated with their strata, the most serious problem with the theory is the existences of affixes whose behaviour is compatible with both strata (Giegerich, 1999). Regarding the suffix *-able*, *appreciable* is non-compositional 'substantial' (i.e. a stratum 1 rule), while *appreciatable* is compositional 'able to be appreciated' (i.e. a stratum 2 rule); *-able* also can be stress-shifting (*cómparable*) and also stress-neutral (*compáritable*) which again affects the

semantic transparency ('roughly the same' and 'able to be compared', respectively) (Giegerich, 1999, p. 29). Accordingly, the theory wrongly excludes the existence of one of these examples (Plag, 1996, p. 771). For the suffix *-ment*, it is assumed to belong to stratum 2; however, it is also compatible with the characteristics of stratum 1 outputs in terms of phonology, semantics, and productivity and this is further supported by examples such as *fragmental* where a stratum-1 suffix *-al* attaches to it. Giegerich (1999, pp. 26-50) discussed a number of affixes whose behaviour is not confined to one stratum: *-esque*, *-ant/-ent*, *-ess*, *-ee*, *-ette*, *-er/-or*, *-ise*, *-(e)ry*, *-ism/-ist*, *-ous*, *-y*, *-less*, *-ness*, *-ful* and *-some*.

(c) *Affix stacking failure*: the theory also fails to restrict the stacking of suffixes of the same level – namely, which suffix has precedence to apply; for instance, the theory does not explain why the pair of suffixes in **sensu+ous+ize* fails to attach (Giegerich, 1999, p. 12).

As a result of these problems, as well as other issues not mentioned here (see Giegerich, 1999, for a comprehensive critical review), doubts have been cast on the theory such that even the predictions that were successfully demonstrated by other data have been given alternative accounts.

Fabb (1988) was among many linguists who discredited the theory. Alternatively, he claimed that affix stacking is constrained only by the idiosyncrasies of the suffixes involved; in other words, every suffix is diacritically marked with what it selects for. Fabb tested the combinatorial possibilities of 43 suffixes with free forms, categorising them into four groups,

as organised in Table 1 below (examples were taken from Plag, 1996, pp. 775-791).

Table 1. *Suffixes and their selectional restrictions.*

Category	Selectional restriction
Group 1: Suffixes attach only to underived words	<p>a. abstract-noun-forming suffixes: Deverbal: -ment (government), -age (steerage), -ance (annoyance), -al (betrayal), -y (assembly) Denominal: -hood (nationhood), -ism (despotism), -age (orphanage), -y (robbery)</p> <p>b. person-noun-forming suffixes: Deverbal: -ant (defendant) Denominal: -ist (methodist), -an (librarian)</p> <p>c. Relational-adjective-forming suffixes: Deverbal: -ful (forgetful), -ory (advisory), -ive (restrictive), -ant (defiant) Denominal: -ous (speacious), -y (hearty), -ful (peaceful), -ly (costly), -an (reptilian), -ish (boyish), -ed (moneyed) Deadjectival: -ly (deadly)</p>
Group 2: Suffixes appear on the periphery of one other suffix	<p>Noun-forming -ary follows -ion (revolutionary) Adjective-forming -ary follows -ion (revolutionary) Denominal -er follows -ion (vacationer); -ic follows -ist (modernistic); -(at)ory follows only -ify (modifier) Deadjectival -y follows -ent (residency)</p>
Group 3: Suffixes show only one restriction involving parts of speech	<p>Denominal -able: attaches to nouns Deverbal -er: attaches to verbs Deadjectival -ness: attaches to adjectives</p>
Group 4: Problematic suffixes	<p>Denominal -al attaches to -ion, -ment, -or The nominalising suffix -ion attaches to -ise, -ify, -ate The nominalising suffix -ity attaches to -ive, -ic, -al, -an, -ous, -able The deadjectival suffixes -ism, -ist, -ise attach to -ive, -ic, -al, -an</p>

Fabb's influential account of suffixation has not remained unchallenged. Plag (1996) refuted it, arguing that it itself suffers from empirical and theoretical shortcomings resulting from the core concept shared with Kiparsky's level ordering—namely, the suffixation is governed by affix-driven restrictions. On the other hand, Plag (1996) and Giegerich (1999) argue that the selectional restrictions should be base driven. Most interestingly, for Giegerich the stratified approach to English morphology can be maintained if it is base driven; hence, it is called the base-driven stratification. As we shall see later in the subsequent sections, unlike Kiparsky's and Fabb's affix-driven restrictions, the predictive power of the base-driven stratification theory is neither too strong by predicting impossible combinations of bases and suffixes nor too weak by ruling out well-formed derivations. I shall first discuss some of the problems associated with Fabb's account. The main aim here is to clarify that the selectional restrictions driven by affixes cannot be maintained. I will mention only one or two counterexamples cited from Plag (1996) for each of the groups in Table 1, accompanied with a very brief defence of the base-driven stratification, as this model will be discussed in more detail in the next section.

For group 1, Fabb's account has been proven to be weak because it excludes well-formed words, such as the denominal abstract-noun-forming suffixes *-hood*, *-ism*, and *-age* are assumed to attach to underived nouns, thereby wrongly ruling out forms such as *expansionism*, *libertarianism*,

Absenteeism, farmerhood, beggarhood, loverhood, portorage, and lighterage (Plag, 1996, p. 782).

With respect to the selectional restriction of the denominal person-noun-forming affix *-an*, some forms are problematic because it is difficult to identify whether they are simple or complex forms, such as whether *library* is a simple or complex form analysed into the bound root *libr-* and the suffix *-ary* ('a place for' OED2). It will be an obvious problem if it is analysed as a complex form because, according to Fabb's account, *-an* attaches to underived nouns (Plag, 1966, p. 783). As we shall see later in (§ 2.3), this question is unproblematic within the theory of base-driven stratification because the answer depends on the speaker's analysis of the base: (i) if it is a bound root *libr-* it will then have *-ary* listed in its lexical entry to form *library*, and the lexical entry of the output will have *-ian* in its list to form *librarian*; or (ii) if it is analysed as a simple form *library*, then the lexical entry is listed with the suffix *-ian* to form *librarian*.

For group 2, Fabb's generalisation 'the deadjectival abstract-noun-forming *-y* attaches only to *-ent* (e.g. *resident* → *residency*)' excludes examples in which *-y* attaches to *-ate*, such as *intimate* → *intimacy*, *private* → *privacy*, and *literate* → *literacy*. As we shall see in the next section, bases such as *resident*, *intimate*, *literate*, and *private* are assigned to the root stratum on which the lexical entries of each of these root bases will have the suffix *-y* in its list as a concatenation option.

For the third group, Fabb's generalisation assumes that *-able*, *-er*, and *-ness* are fully productive in the sense that they always apply successfully to nouns, verbs, and adjectives, respectively. This account, however, is too strong because it predicts impossible combinations such as **inhabiter* and **longness*. In fact, the stratified approach, whether affix or base driven, posits that *-er* and *-ant*; *-ness* and *-ity*; *-ness* and *-th* are competitors. Suffixes applied at stratum 1 forbid rival suffixes from application at stratum 2 (e.g., *-th* blocks *-ness*; *'length* blocks **longness'*; *-ant* blocks *-er*; *'inhabitant* blocks **inhabiter'*). The suffix *-able* not only attaches to nouns, but also to verbs (e.g., *appreciatable*, *demonstratable*, *navigatable*, *toleratable*) and bound roots (e.g., *appreciable*, *navigable*, *demonstrable*, *tolerable*) (Giegerich, 1999, pp. 28-29). The suffix *-able* attaching to a part of speech only as suggested by Fabb faces the problem that bound roots in fact lack lexical-category specification which is motivated by bound roots that can be labelled with more than one lexical category (e.g., [matern-]_{N or Adj}; [bapt-]_{V or N}) (see § 2.3.1, for further details). The base-driven stratification, on the other hand, does not restrict *-able* to a part of speech; rather, the characteristics of the base identify whether *-able* attaches to it or not. To say it briefly here, *appreci-* which does not bear a lexical category is assigned to stratum 1 (root stratum); *able* is listed in its lexical entry as a concatenation option. However, the productivity, phonology and semantic compositionality of *appreciatable* supports the view that it has undergone the affixation rule at stratum 2 (word stratum) (i.e., *-able* is inserted in the environment of [appreciate__]_N). For the suffixes of the

final group, Fabb regarded them as problematic as their selectional restrictions cannot be sharply defined. Mentioning one example, the suffix *-al* should not attach to already suffixed nouns; however, there are examples in which *-al* attaches to *-ment* (e.g., *fragmental* vs. **discernmental*). In addition, the base-driven stratification provides very compelling evidence for the importance of the base suffix in determining whether *-al* can attach to it or not (see § 2.3.3.3 for more details).

To sum up, any account for suffixation that is affix driven is unsustainable; it will face the problem of predicting ill-formed derivations or excluding well-formed ones.

2.3 The Base-driven Approach to Lexical Stratification

Selkirk (1982) proposed an early model of base-driven stratificational model of English morphology. The lexicon consists of two disjunctively ordered strata: root and word. Giegerich (1999) greatly elaborated on it in his book *Lexical Strata*, arguing that the stratified approach that provides a systematic explanation for English morphology is achievable if it is primarily driven by the characteristics of affixation bases. The drivenness of the base is mainly motivated by the characteristics of the root stratum. In this section, I will first review the properties of the two strata and then discuss how the model successfully tackles the problems causing the affix-driven stratification approach to fail, by providing examples of derivations within the model. Finally, but most importantly to this research, I will discuss the

gap resulting from the assignment of the regular plural inflection to stratum 2 along with compounding.

2.3.1 The root *stratum*

The definition of ‘root’ in this theory is completely different from the traditional definition because it can be complex. Its complexity arises from ‘recursivity’, which is an essential feature of this stratum first proposed in Selkirk (1982). Forms such as *sensation*, *sensational*, and *sensationality* are categorised as roots, unlike previous affix-driven models that give these forms the status of wordhood.

As in other stratification models, stratum 1 is defined by its cyclic phonological rules (e.g., stress shifting ‘*télégraph* versus *telegraphy*’; trisyllabic shortening ‘*nation* versus *national*’; base allomorphy ‘*deep* versus *depth*’). The stratum is also generally characterised by its non-productivity, which is attributed to its bound roots whose suffixation is synchronically inexplicable. The bound roots of each of the groups in (60) below are semantically related, yet their affixation patterns cannot be given a systematic account:

- (60) a. spir- -ant *-ant
 conson- -ant *-ent
 sonor- -ant *-ent
 obstru- *-ent -ent
- b. mater- *-ar -al -ity *-ise
 patern- *-ar -al -ity *-ise
 fratern- *-ar -al -ity -ise
 avuncul -ar *-al *-ity *-ise
- (Giegerich, 1999, p. 63)

The relationship between roots and stratum-1 affixes are redundant and cannot be subject to affixation rules; for example, the generalisation '–ise attaches to members of the lexical category N to form verbs' excludes forms in which the suffix –ise can attach to bound roots, as in *baptise*, and to adjectives such as *velarise* and *publicise*. The restrictions on productivity then necessitate 'listing' at that stratum; the lexical entries of the root bases are listed with potential suffixes.

Non-productivity is strongly linked with semantic non-compositionality (Aronoff, 1976; Giegerich, 1999). Stratum-1 formations are generally characterised by their semantic non-compositionality for two reasons. First, the meaning of the complex form is not derivable from the concatenation of the root and the affix; for example, *-ity* (a stratum-1 suffix) and *-ness* (a stratum-2 suffix) are rival suffixes that form abstract nouns from adjectives (e.g., *intensity* and *goodness*). However, the meaning of abstractness is not always derivable by *root + -ity* because the meaning of a count noun is also conveyed by that concatenation (e.g., *fatality*, *calamity*). Second, and more interesting, semantic non-compositionality can be attributed to the meaninglessness of many bound roots. Bound roots, whether recurrent (e.g., *fraternise*, *opportunity*, *receive*, *deceive*, *reduce*, *conduce*) or non-recurrent (e.g., *gormless*, *modify*, *regiment*), do not contribute to the meaning of their complex forms. In addition, the notion of listing here manifests itself; each of the outputs of stratum-1 morphology must be listed

for its special meaning (e.g., *appreciable* is listed with the meaning ‘substantial’).

In sum, the affixation rule on stratum 1, like the one proposed by Kiparsky (1982) (see (56) above), is abandoned due to the unproductivity and semantic non-compositionality of its morphology. I shall discuss with examples later in (§ 2.3.3.4) how listing contributes to blocking failures (e.g., *learned/learnt*).

Another feature is that the members of the root stratum are not specified for syntactic category. The lack of categorisation is strongly motivated by Giegerich’s observation (1999, p. 74) that not all bound roots can be labelled with a syntactic category. For example, *moll-* is an ‘adjective root’ as *-ify* only attaches to it, forming the verb *mollify* (i.e., in analogy to $\text{false}_{\text{Adj}} \rightarrow \text{falsify}_{\text{V}}$); *gorm-* is labelled as a ‘noun root’ as *-less* only attaches to it, forming the adjective *gormless* (i.e., in analogy to $\text{hope}_{\text{N}} \rightarrow \text{hopeless}_{\text{Adj}}$). However, Giegerich noted that it is problematic to label a bound root like *matern-* because it has two potential suffixes: *-ity* that attaches to nominal bases and *-al* that attaches to adjectival bases. An important consequence of this feature is that it distinguishes between roots and words as both members are alike in terms of recursivity.

A final point regarding this stratum is that the lexical entries of stratum-1 members must be listed with the rule of root-to-word conversion in (63) below, along with the lexical category it specifies; it simply associates outputs of stratum 1 with their lexical category as a closing process before

they get access to either the next stratum or to syntax (Giegerich, 1999, pp. 76 & 78):

(61) Root-to-Word Conversion

$[]_r \rightarrow [[]_r]_L \quad (L = N, V, A)$

I shall provide later in (§ 2.3.3.1) examples of how this rule can be implemented.

2.3.2 The word stratum

This stratum comprises words (i.e., the inputs of root stratum, derived or underived); derivational (e.g., *-ly*, *-hood*, *-like*) and inflectional affixes (e.g., the regular plural suffix *-s*, the past tense suffix *-ed*) that only figure in the affixation rule proper. Unlike the preceding stratum, the output here is defined by its non-cyclic phonological rules, productivity (i.e., forms can be predicted or generalised unless they are blocked by the elsewhere condition in (59) above), and semantic compositionality (i.e., the constituents of the complex form contribute to the meaning of the whole word). The morphological and semantic properties of this stratum motivate the affixation rule in (56) to operate on it.

Compounding is assigned to this stratum. As discussed in (§ 1.1), the notion of word in lexicalism posits a sharp divide between the lexicon and syntax (Di Sciullo & Williams, 1987); however, the clear-cut separation is undermined by the hybrid behaviour of many compounds. Kiparsky's (1982) level-ordering model sharply separates the stratified lexicon from syntax. Even if the interaction was allowed, this would happen between stratum 3

and syntax. However, compounding occurs at stratum 2, which means that all compound words should show pure lexical characteristics, but as shown in (§ 1.1), this is not true. The BDS model evades this problem by supporting an overlap between stratum 2 and syntax. Yet the mechanism is not clear. As a notion, it provides a possible explanation for lexical structures like compounds that bear features associated with syntax.

Furthermore, the BDS model faces the problem of assigning compounding and regular inflections to this stratum because it will allow for ill-formed compounds to be generated (e.g., **toys box*). I will return to this issue in (§ 2.3.3.6)

2.3.3 The implementation of the base-driven stratification

The base-driven approach to lexical stratification addresses the problem associated with affix-driven models; in addition to the phenomenon already discussed regarding the dichotomy between root- and word-stratum outputs in terms of productivity, semantics, and phonology, the model also shows that its predictive power is neither too weak or too strong by successfully predicting the possible formations and excluding the impossible ones. In this way, it is able to account for affix stacking on the same stratum and for the duality of suffixes. The model is also able to account for the blocking failures. However, as far as the morphological side of the theory is concerned, the most obvious problem encountered in BDS is that the assignment of the regular plural and compounding to the word stratum

predicts that both rules can interact freely, an issue that will be addressed in (§ 2.3.3.6).

2.3.3.1 Morphology of the root *stratum*

At this stratum, basic roots and affixes constitute lexical entries listed with potential affixes, offering what is called ‘concatenation options’, as illustrated below:

- (62)
- a. *serene* $\left\{ \begin{array}{l} \text{-ity} \quad \text{‘attach -ity to [serene]’} \rightarrow \text{[[seren]ity]} \\ \text{-ade} \quad \text{‘attach -ade to [serene]’} \rightarrow \text{[[seren]ade]} \end{array} \right.$
- b. *warm* $\left\{ \begin{array}{l} \text{-th} \rightarrow \text{warmth} \end{array} \right.$
- c. *nation* $\left\{ \begin{array}{l} \text{-al} \rightarrow \text{national} \left\{ \begin{array}{l} \text{-ity} \rightarrow \text{nationality} \\ \text{-ise} \rightarrow \text{nationalise} \left\{ \begin{array}{l} \text{-ation} \rightarrow \text{nationalisation} \end{array} \right. \end{array} \right. \end{array} \right.$

The root *serene* has two concatenation options; with *-ity* to form *serenity* and *-ade* to form *serenade*, while the lexical entry of the root *warm* has only one affix in its list. Similarly, roots ending with the suffix *-al* have two concatenation options (e.g., *national* → *nationality*; *national* → *nationalise*), while the suffix *-ise* has the suffix *-ation* listed in its lexical entry (e.g., *nationalise* → *nationalisation*). Affixes such as *-th*, *-ity*, and *-al* are diacritically marked exclusively for the root stratum because they only appear as options listed for particular stratum-1 bases in contrast to affixes that only involve affixation rules at stratum 2 (e.g., *-hood*). The concatenation option(s) of each

base is idiosyncratic and its ‘implementation...constitutes what we mean by “the morphology of stratum 1”’ (Giegerich, 1999, p. 96).

The above examples demonstrate that the model can account for affix stacking; *-ity* cannot precede *-al* (e.g., **nation-ity-al*). The affix-driven stratification fails to account for the stacking of affixes of the same stratum, and this is one of the flaws that Fabb has taken in support of his rejection of a stratal approach. The BDS model has no problem with this because the explanation lies in the base, not the suffix. Stratum-1 suffixes *-al* and *-age* are not listed in the lexical entries of roots ending in *-ise*, *-ify*, and *-ate* (e.g., **magnify-age*, **concentrate-al*, **verbalise-al*) (Plag, 1996, p. 776). The suffix *-ation*, on the other hand, is found in their lists:

- (63) a. magn- { -ify } → magnify { } → magnification
 b. verbal { -ise } → verbalise { -ation²⁸ } → verbalisation
 c. concentr- { -ate } → concentrate { } → concentration

The root *steer* has *-age* in its list, forbidding other unlisted suffixes such as *-al*:

- (64) a. steer { -age } → steerage
 b. *steer { -al } → *steer-al

Recall that the outputs of stratum 1 are not specified for lexical categories, a feature that distinguishes between roots and words. The rule in (61) above is probably the only solution that enables the outputs of stratum 1

²⁸ [-ification] in *magnification*, [-ation] in *verbalisation*, and [-ion] in *concentration* are phonologically conditioned allomorphs of *-ation* (Plag, 1996, p. 776).

to be inputs for the word stratum or to gain access to syntax; for example, the root *accident* cannot be suffixed with the regular plural on the next stratum unless it is associated with the lexical category N. Once the rule of conversion has been carried out on the inputs of stratum 1, no further morphological process can operate as the inputs become words ready for transfer into the next stratum or directly to the syntax.

(65) **nation** $\left\{ \begin{array}{l} [1] \text{ -al} \\ [2] \text{ (rule of root-to-word conversion)} \end{array} \right.$

(66) **-al** $\left\{ \begin{array}{l} \text{-ity} \\ \text{-ize} \\ \text{(rule of root-to-word conversion)} \end{array} \right.$

However, without another mechanism, all roots—including bound roots—would be allowed to undergo this rule. Giegerich proposed that roots are diacritically marked; each root has a lexical entry in which all information about the morphological processes these roots can undergo is listed. For example, *matern-* is specified as a bound root, which prevents it from going through the rule in (61) above until it selects one of its potential affixes, *-al* or *-ity*:

	Cycle 1	Cycle 2
(67)	{	$[[\text{matern}]_r \text{ al}]_r$
[matern] _r		$\left\{ \begin{array}{l} \rightarrow \dots (?)^{29} \\ \rightarrow [[[\text{matern}]_r \text{ al}]_r]_A \rightarrow (\text{to stratum 2}) \end{array} \right.$
		$[[\text{matern}]_r \text{ ity}]_r$
		$\left\{ \begin{array}{l} \rightarrow \dots (?) \\ \rightarrow [[[\text{matern}]_r \text{ ity}]_r]_N \rightarrow (\text{to stratum 2}) \end{array} \right.$
		$*[[\text{matern}]_r]_L (n/a)$
		(Giegerich, 1999, p. 78)

2.3.3.2 Morphology of the word *stratum*

Listing on stratum 1 is significantly motivated by the morphology of the *stratum*. On the other hand, the productivity and semantic compositionality of stratum-2 morphology motivate Kiparsky's affixation rule, repeated below, to operate on the word *stratum*:

- (68) Insert A in env. [Y_Z]_X
[Y_Z]= "subcategorisation frame" of A, X= "inherent categorical information"

Words are inserted into the categorical frames which are associated with a number of features. Derivational and inflectional affixes are inserted in the context of the appropriate lexical category.

For derivational morphology, the suffix *-er* can appear in the affixation rule to form a deverbal:

- (69) Rule: Insert *er* in env. [V__]_{Noun, +Agent}
a. Insert *er* in env. [employ__]_{Noun, +Agent}
b. [[employ]_V -er]_{Noun, +Agent}
c. employer

²⁹ This depends on the speaker's list, i.e. on his/her knowledge of how many affixes can attach to the root (Giegerich, 1999).

Many verbs allow nouns to be formed by a suffix such as *-er*, unless it is blocked by a semantically rival stratum-1 suffix *-ant* in accordance with the elsewhere condition:

- (70) a. inhabit { -ant (agent) → inhabitant }
 b. account { → accountant }
- (71) a. *inhabiter
 b. *accounter

Note here that *stimulant* does not block *stimulator* because they do not share the same meaning; the former refers to a substance whereas the latter refers to a person or device (Kiparsky, 1982, p. 7).

Regular inflections are also subject to the affixation rule:

- (72) a. Insert /z/ in env. [boy__]_{Noun, +plural} = boys
 (73) a. Insert /ɪd/ in env. [hunt__]_{Verb, +past} = hunted

As the strata are disjunctively ordered, stratum-1 affixes cannot attach to the outputs of the affixation rule:

- (74) a. **Root stratum:** Darwin { [[[[Darwin]_r ian]_r]_A } → to the word stratum
- b. **Word stratum:** Insert *ism* in env. [Darwinian__]_{Noun} = Darwinianism³⁰
 *Insert *ian* in env. [Darwinism__]_{Noun} = Darwin-ism-ian

2.3.3.3 The dual membership of affixes

As mentioned earlier in (§ 2.2), one of the serious flaws encountering Kiparsky's model is the non-conformity of affixes to the ordering of the

³⁰ The form *Darwinianism* is taken from Gordon (1985, p. 74)

strata; for example, *-ment* is assumed to be diacritically marked for stratum 2 but in some cases we find a stratum-1 affix attached to it (e.g., *fragmental*), thereby jeopardising the concept of lexical stratification (Fabb, 1988). As also discussed in (§ 2.3), the stratified approach can be strongly defended if the base is seen as the source of information for English morphology; for the duality of affixes, the BDS provides a principled explanation, as Giegerich (1999, p. 96) states:

An English affix may or may not figure in the affixation options (for stratum 1) with the roots of the language; and it may or may not figure in an affixation rule proper. If both are the case then the affix can be said to 'occur' on both strata. If only the former is the case then the affix attaches on stratum 1 only. And if only the latter is the case the affix attaches on stratum 2 only.

I cite examples of two suffixes that show dual-stratum affiliation; their locus of application is determined by their bases:

a. -ment can attach to bound roots at stratum 1 or words at stratum 2.

At stratum 1, roots such as *orna-*, *inre-*, *regi-*, and *frag-* have the suffix *-ment* in their lists, and the output of concatenation conforms to the general characteristics of the root stratum—namely, unproductivity and semantic non-compositionality. The suffix *-ment* in such cases is a stratum-1 member that can accept another stratum-1 member *-al*. On the other hand, *-ment* can also appear in the affixation rule to be attached to words such as *employ*, *contain*, *discern*, and *derange*. The outputs conform to the characteristics of stratum 2 in terms of productivity and semantics. The stratified approach here manifests itself in that such formations do not accept the attachment of

the stratum-1 suffix *-al*. Giegerich (1999, p. 55) demonstrated in (75) below that the behaviour of *-ment* is systematic:

(75)	a.	ornament	*ornav	ornamental
		increment	*increv	incremental
		regiment	*regiv	regimental
		fragment	*fragv	fragmental
	b.	employment	employv	*employmental
		discernment	discernv	*discernmental
		containment	containv	*containmental
		derangement	derangev	*derangemental

b. *-less* attaches to bound roots (e.g., *gormless*, *feckless*) as well as to word bases (e.g., *hopeless*, *homeless*). The sequential property of the model forbids the stratum-1 suffix *-ity* to attach to *-less* (e.g., **homelessness*). Similarly, *feckless* and *gormless* do not accept another stratum-1 member like *-ity* either (**gormlessness*, **fecklessness*). Here the straightforward explanation within the BDS model is that *-ity* is not one of the concatenation options for the lexical entry of the suffix base *-less*, thus forbidding the formation *-less-ity*. Again, the BDS model here successfully accounts for the stacking of affixes on the same stratum – a problem associated with affix-driven restrictions.

2.3.3.4 Blocking effect and blocking failure

The notion of listing discussed in (§ 2.3.1) above has an implication for the phenomenon of blocking. In Kiparsky's model, blocking is a consequence of the affixation rule that operates on stratum 1. Blocking takes effect when the special rule competes with the general rule; the winner should always be the special rule in accordance to the elsewhere condition (e.g., *oxes* is blocked

by *oxen*). Meanwhile, in Giegerich's model, blocking occurs as a consequence of listing when other factors such as semantics and blocking failures are taken into consideration. The suffixes *-th* (on stratum 1) and *-ness* (on stratum 2) are semantically rivals: Both derive abstract nouns from adjectives. However, **longness* fails to occur because it is blocked by the special form *length* (Giegerich, 1999, p. 61).

Blocking might also fail, especially in cases of inflectional morphology resulting in 'doublets' (e.g., *learnt/learned*; *spelt/spelled*; *cacti/cactuses*; *referenda/referendums*) (Kiparsky, 1982; Giegerich, 1999). Recall that the present model does not have to answer the question of whether a root is a simple or complex form (e.g., whether *library* is analysed into 'lib- + -ary' or an underived form) because it depends on the speaker's analysis of the form. Similarly, for doublets, one of the forms is used according to the speakers' analysis or even taste. For example, speaker A might prefer the Latin plural form *referenda* (a stratum-1 output) whereas Speaker B might prefer to regularly pluralise *referendum* 'referendums' (a stratum-2 output). For speaker A, two analyses are possible: (i) a bound root + a suffix or (ii) an underived form with the plural semantics. The three options for deriving *referendums/referenda* are illustrated in (76) and (77) below:

(76) Speaker A (*referenda*; a stratum-1 output)

a. referen- { -da 'attach -da to [referen]_r → [[[referen]_r da]_r]_{N+ plural} }

OR

b. [referenda]_r → [[referenda]_r]_{N+plural}

(77) Speaker B (referendums; a stratum-2 output)

Insert /z/ in env. [referendum__]_{N+plural} → referendums

2.3.3.5 Compounding

I will tentatively incorporate Lieber's lexical semantic approach to compounding and will explain the reason for that at the end of the section.

Lieber's analysis is characterised by three major elements:

(a) *The semantic skeleton*: The lexical item is made up of a combination of semantic features that are binary in value. Lieber (2009) proposes seven features: [±material], [±dynamic], [±location], [±Inferable Eventual Position or State], [±Bounded], [±Composed of Individuals], and [±scalar]³¹. For example, [+material] characterises a concrete noun, while the negative value characterises the mass noun; a lexical item with the [+dynamic] feature refers to an event/process in contrast to the concept of a situation. In English, these features are important for syntax; they constitute functions that take one or more arguments; in (78), the functions and their arguments are organized hierarchically:

(78) a. [F1 ([argument])]
b. [F1 ([argument], [F2 ([argument])])]
(Lieber, 2004, p. 16)

(79) **Lexical item** **Skeleton**
a. chef [+ material, + dynamic ([])]
b. kiss [+ dynamic ([], [])]
c. red [dynamic, + scalar ([])]
(Lieber, 2009, p. 81)

³¹ Lieber (2004, 2009) states that these features might be expanded in future work.

(b) *The semantic body*: Lieber (2009, pp. 82-83) suggests that the semantic body encodes:

various perceptual, cultural, and otherwise encyclopaedic aspects of meaning including shape, size, or dimension, colour, orientation, origin, use, and so on, and that precise contents of the semantic body can differ from one speaker to another.

Part of the semantic body is systematic which includes 'the universal semantic features' that speakers should be aware of (e.g., *dog* <animate>). Another part of the semantic body is available for speakers' specific knowledge or interpretation (e.g., colour, origin, use). The semantic body of *bed* is demonstrated below; the information between the curly brackets is variable among speakers:

- (80) *bed* <- animate>
<+artefact>
<3 dimensions>
{for sleeping, contains comfortable surface, etc.}

(c) *The principle of co-indexation*: As far as compounding is concerned, the mechanism described in (81) below concatenates two skeletal parts to form compounds (Lieber, 2004, p. 61).

- (81) **Principle of Co-indexation**: In a configuration in which semantic skeletons are composed, co-index the highest nonhead argument with the highest (preferably unindexed) head argument. Indexing must be consistent with semantic conditions on the head argument, if any.

As the indexes of the two stems are shared, the reference and the interpretation are shared as well (i.e., a single referential unity). The concatenated form will then be treated as a single word in syntax. In the

schema below, the skeletons of the two stems are put together ‘in a relationship of sisterhood’:

(82) [α F1 ([])] [β F2 ([])]

In an ideal situation, the principle of co-indexation achieves ‘the complete identification of the reference’ (i.e. the stems are predicted of the same entity), but this is not always the case as the lexical skeletons and the semantic bodies of the two stems involved play a role in that. For example, for copulative compounds (e.g., *clergyman-poet*, *producer-director*), the skeletons of the stems share similar properties, as shown below:

(83) Skeleton	[+material, dynamic ([i])]	[+material, dynamic ([i])]
	Clergyman	poet
Body	<natural>	<natural>
	<human>	<human>
	<male>	<writes poetry>
	<cleric>	

(Lieber, 2004, p. 51)

The two stems are substantially similar— namely, both are natural and human; the skeletons are also identical. The mechanism of co-indexation has a strong effect for giving complete identification.

The picture, however, is different with endocentric attributive compounds (e.g., *dog bed*), as demonstrated below:

(84) Skeleton	[+material ([i])]	[+material ([i])]
	dog	bed
Body	<natural>	<artefact>
	<animate>	<furniture>
	<canine>	<horizontal surface>
		<for sleeping>

The effect of co-indexation in this compound is not strong. The skeletons are identical, but the bodies are different. As a result, the mechanism is able to identify that the second stem is semantically the head of the compound, and both stems have only a single referent, but cannot identify the ultimate interpretation of the concatenated form. As the head of the compound is *bed*, the question here is how a substantially different stem like *dog* relates to it. Here Lieber argues that the juxtaposition of the two stems create the meaning of association (e.g., '*a dog bed is a bed that somehow associated with a dog*'). The ultimate meaning will vary from one speaker to another depending on the context or one's encyclopaedic knowledge. For example, the head in *daybed* and *dog bed* is somehow associated with *day* and *dog*, respectively, but the context or speaker's interpretation would tell us that the former means '*a bed that is used during the day*' while the latter means '*a bed that a dog sleeps in*'.

Having briefly discussed some of the features of Lieber's theory, the relevant property of interest is what Lieber (2009) describes as follows:

Body features clearly also play a role in the likelihood that a compound will be coined. For example, given the choice between the nouns *van* and *peanut butter* as the first element of a compound in which the second element is the noun *driver*, clearly the features of *van* are more compatible with *driver* than are the features of *peanut butter*.

As far as the regular plural and compounding are concerned, the question here is what makes it possible for *enemies list* to be coined but not **toys box*. The failure of co-indexation in the latter can be seen in that the non-

head *toys* still maintains the meaning of ‘many individuated items’, while in the former *enemies* acquires the meaning of ‘type’ as a result of the concatenation. This suggests that the semantic feature of the first stem plays ‘a role in the likelihood that a compound will be coined’. Indeed, I will argue in Chapter III that the semantic property of the first stem is very important for allowing the regular plural to appear inside compounds. Possessive inflections will also be considered. With respect to the stratificational model adopted in this research, I will incorporate Lieber’s analysis as I aim to address the gap associated with the model regarding the assignment of the regular plural and compounding to the same stratum (stratum 2). I shall discuss the problem in the following section.

2.3.3.6 The regular plural inside compounds

As mentioned earlier in (§ 2.1), affix-driven stratificational models such as Kiparsky’s (1982) and Mohanan’s (1982) posit a third or fourth stratum, respectively, for the regular inflection, motivated by the observation that the regular plural never appears inside derivations (e.g., **eventsful*) or is found on the left member of a compound (e.g., **cups dispenser*). For plurals inside compounds such as *drinks cabinet* or *alms-giving*, they are formed at stratum 1 for their idiosyncrasy so they can be inputs for compounding at the next stratum (stratum 2 for Kiparsky’s model or stratum 3 for Mohanan’s model). However, this motivation has been considerably weakened by many examples of compounds whose left member is a semantically compositional

regular plural noun (e.g., *appliances industry, weapons inspector, antiques shop*). Sproat (1985), who rejects the stratified approach, used such counterexamples as further evidence for his argument. The BDS model which is proved superior to the affix-driven approach finds no motivation for a third stratum for regular inflections either; alternatively, it assigns them to the word stratum. However, the problem with which this research is mainly concerned is that the model does not posit any constraint that governs the interaction between the rules of regular pluralisation and compounding. We would then expect that the regular plural can appear freely inside compounds; yet this is undoubtedly wrong. Accordingly, the main question the present research seeks to answer within the BDS model is what motivates the regular plural to appear inside compounds. If we reverse the question, we can ask what forbids the regular plural to appear inside compounds. Psycholinguistically, the latter question takes the form of why people dislike the regular plural inside compounds—a question that has been extensively investigated to support theories such as level-ordering, dual mechanism, and connectionism. Different constraints have been suggested. Within level ordering and dual-mechanism, it is attributed to morphology (e.g., Kiparsky, 1982; Berent & Pinker, 2007, respectively); within connectionism, it is attributed to phonology and semantics (e.g., Haskell et al., 2003) or phonology and orthography (e.g., Buck-Gengler, Menn, & Healy, 2004). I will discuss these constraints in (§ 3). I shall argue in (§ 4) that the failure of these constraints is ascribed to the generalisation that assumes that

the absence of the regular plural is a robust phenomenon. The BDS model, on the other hand, does not rule out the phenomenon, but the gap mentioned above needs to be addressed.

3. CONSTRAINTS AGAINST THE REGULAR PLURAL INSIDE COMPOUNDS

3.1 Morphological Constraint: Dual-Mechanism and Level

Ordering

The morphological constraint against the regular plural appearing inside compounds rests on the original assumption that regular inflections are qualitatively different from irregular inflections. The constraint originated from two different theories, dual-mechanism and level ordering, both of which concur that irregular morphology is memory-based, whereas regular morphology is rule-based. Both are consistent with the idea that the rule governing the formation of regular inflection occurs after the stored forms and the rules of compounding (Berent & Pinker, 2007; Haskell et al., 2003; Kiparsky, 1982).

According to the dual-mechanism model, the mind has two different systems capable of processing regular and irregular inflections³²: a mental grammar and a mental lexicon (or an associative memory),³³ respectively. In

³² Clahsen, Sonnenstuhl, & Blevins (2003, p. 125) also argued that derivational morphology can be explained within the model of dual-mechanism.

³³ The memory is called associative because it establishes a link between stored forms, e.g. *sing/ sang/ sung; child/ children*. According to Pinker & Prince (1992), frequency and

the associative memory, irregular forms are stored as wholes. For example, a word pair like *mouse* and *mice* is stored in the lexicon separately in the sense that they are retrieved as *mouse* and *mice*. In the mental grammar, lexical stems and inflectional suffixes supplied by the lexicon undergo combinatorial operations; the regular plural noun of *cat* does not occur in the lexicon but is a product of the application of the plural marker *-s* to the stem noun *cat*.

The combinatorial operations are productive and yield morphologically complex forms with predictable meanings. Moreover, the two systems interact in the sense that the retrieval of an irregular item will block the application of the rule (e.g. Clahsen, 1995; Clahsen, Rothweiler, Woest, & Marcus, 1992; Marcus, Brinkmann, Clahsen, & Pinker, 1995; Pinker & Prince, 1988, 1992).

The organisation of the lexicon proposed by Kiparsky (1982) predicts the following:

a. The regular plural suffix should not appear within compounds; once a compound is created at stratum 2, its internal element cannot receive the regular suffix *-s* (a rule that occurs at stratum 3).

similarity affect the irregular inflection system. For example, children over-regularise an irregular form if they do not hear the correct irregular form frequently (e.g. *mouses*, *tooths*, etc.). As for similarity, Pinker & Prince noted that, in the associative memory, overlaps occur between words sharing similar features that make them easier to learn. For example, the irregular forms *string* → *strung* and *shrink* → *shrunk* can be easily learned because they share phonological features. In contrast, regular plural forms are not affected by these factors because they are rule-governed. This contrast illustrates the dissociation between regular and irregular inflectional systems.

b. Irregular plurals, on the other hand, can be used within compounds as this rule occurs at a stratum prior to that at which compounds are created (e.g. *teeth marks, lice-infested*).

c. As in the case of irregular plurals, pluralia tantum (stratum 1) can also appear within compounds. Kiparsky argued that they inherently carry the feature [+ Plural], making them different from the regularly inflected nouns created at stratum 3 and, accordingly, the underlying representation of such pluralia tantum carries the -s morpheme that consequently should appear within compounds.

Psycholinguistically, the three predictions were confirmed by an experiment Gordon (1985) conducted on 33 English-speaking children between the ages of three and five. Gordon argued that the level ordering of the lexicon is innate. He predicted that children who learnt the use of the regular plural should be able to produce compounds without an internal regular plural³⁴. For irregular plurals, they produce it within compounds, once they have learned to stop over-regularizing the irregular plurals.

The task was designed to elicit singular, plural and compound forms. Three sets of stimuli were introduced to the children: (i) a set of five nouns (*mouse, man, tooth, foot, goose*) that are irregularly pluralised; (ii) a set of regular nouns *rat, baby, bead, hand, ducks*; and (iii) a set of four pluralia tantum nouns (*clothes, pants, sunglasses, scissors*). Before the main experiment

³⁴ According to Gordon, children's acquisition of the regular plural is evidenced by their over-regularisation of irregular forms such as *tooths, mans*, etc.

was conducted, the researcher trained the children to say compounds by using mass nouns (e.g. rice, wood, etc.); for example, the child was asked “What do you call someone who eats rice?”, and s/he was trained to answer *rice-eater*. The main experiment consisted of three steps. First, the children were asked to produce a singular noun by showing them a single object and asking them to name it. Second, they were required to produce plural nouns by showing them a number of objects and asking them to name them. In the third step, the children were shown a number of objects and were asked a question like “what do you call someone who eats X?”, where X was the same plural form previously used by the child in response to plural-form elicitation questions.

The results were compelling; almost all the children did not use the regular plural noun within compounds (on 161 out of 164 items), but they used the irregular plurals. According to Gordon, children employed level ordering, which is an “innate structural property of the lexicon” (Gordon, 1985, p. 73)—in other words, such ordering does not come about through learning.

3.2 Constraints on the Associative Memory: Connectionism

A connectionist view of inflections favours a single associative system for the representation of the regular and irregular morphologies without recourse to a mental grammar for the regular inflection. The distinction between the behaviour of the two types of inflections can be explained by a

number of factors. For example, Haskell et al. (2003) claimed that native speakers in their experiments did not like regular plural inside compounds because they learned that modifiers within phrases are always unmarked for number, and this learned information was generalised to include modifiers within compounds. Buck-Gengler et al. (2004) suggested that phonological and orthographic factors caused processing difficulty that has affected people's decision on the use of the regular plural inside compounds. Each of these claims will be explained in detail in the following sub-sections. The claims were severely criticised by proponents of the dual-mechanism (Berent & Pinker, 2007; Cunnings & Clahsen, 2007). However, both dual- and single-mechanism theories ignore the very important fact that the regular plural inside a compound is not always absent³⁵.

3.2.1 Phonological-semantic constraint

Haskell et al. (2003) dismissed the role of morphology in the absence of the regular plural inside compounds. A theory like level ordering predicts that regularly inflected non-heads are prohibited from evolving into compounding, whereas irregular plurals can feed into compounding in the same way as uninflected nouns. An expected corollary to this is that both

³⁵ It should also be noted that the aim of including the basic tenets of a non-morphological theory like connectionism is not to evaluate it, but rather to serve as a short introduction to the constraints claimed to govern the appearance of the regular plural in compounds. Morphological theories like level ordering and dual mechanism ascertain the importance of morphology to account for the phenomenon and refute a theory that basically depends on the generalisation of a linguistic experience to other linguistic phenomena, like connectionism, within which a number of constraints have been suggested.

singular and irregular plural nouns will exhibit the same behaviour as non-heads within compounds (i.e. both are perfectly acceptable). Haskell et al. have shown through subsequent experiments that the plural form, whether regular or irregular, is rated as significantly less acceptable than singular forms. Irregular plurals in terms of acceptability are positioned between singulars as the most preferred and regular plurals as the least preferred, which means that there is a graded effect on the acceptability of compounds—a generalisation for which level ordering fails to account.

They alternatively argued that the associative memory is capable of distinguishing between regular and irregular plurals. They suggested two constraints associated with associative memory: semantic and phonological properties of modifiers. The basic idea behind the proposal arises from their observation that first language users, when learning a word, must know how the word sounds, what it means and in what context it should occur (Haskell et al., 2003, p. 131).

Haskell et al. (2003) claimed that two kinds of constraints are imposed on modifiers in adjective–noun sequences: semantic and phonological. They claimed that the semantic constraint is derived from a ‘universal tendency of modification’. Adjectives in English adjective-noun sequences can refer to one or more entities, but may not carry the number feature:

For example, in an adjectival phrase such as red table, the notion of redness is neither singular nor plural; in general, adjectives can apply to one or many entities but do not themselves have number meaning.

(Haskell et al., 2003, pp. 137-138)

Moreover, they claimed that speakers' knowledge about such restrictions on modifiers in adjectival phrases is generalised to include modifiers in noun-noun compounds: the non-head noun in a compound is a modifier and it is unmarked for number semantics:

...the *kitchen* in *kitchen table* does not refer to any specific *kitchen* or *kitchens*, but to the abstract concept of *kitchen-ness*, which is neither singular nor plural. What the child learns from such examples, then, is that there is a strong tendency for modifiers to lack number, including but not limited to modifiers in noun compounds. Thus our semantic constraint applies to all modifiers, for which abundant evidence is available to the child.

(Haskell et al., 2003, p. 138)

Haskell et al. (2003) further argued that the constraint against number should work in conjunction with a phonological constraint; otherwise, irregular plural nouns would never be allowed within compounds. Modifiers ending with /s/ and /z/ are not part of an English speaker's knowledge; accordingly, modifiers that do not exhibit the phonological features typical of singular nouns are disliked within compounds. In this way, the phonological constraint creates the distinction among the types of plurality within compounds. This proposal will accordingly make a number of predications:

1. Unmarked non-head nouns should be fully acceptable because they fulfil two conditions: they are (i) semantically singular and (ii) phonologically singular.

2. In contrast, regular plural non-head nouns should be fully unacceptable because they violate the two conditions: they are (i) semantically plural and (ii) phonologically plural.
3. Irregular plural non-head nouns should be partially acceptable because they fulfil one condition: they are (i) semantically plural but (ii) phonologically singular.
4. Birfucate pluralia tantum non-head nouns should be partially acceptable because they fulfil one condition: they are (i) semantically singular and (ii) phonologically plural.

Haskell et al. (2003) conducted three grammaticality judgment tasks in which the participants had to judge novel compounds on a 7-point scale, with 7 indicating the best compound and 1 indicating the worst.

The first task was to rate compounds containing regular and irregular plurals and their corresponding singular forms:

- (85)
- a. Amy's **toes** had been hurting for several days, and she wanted someone to check them out. She called the clinic to schedule a **toe** examination.
 - b. Amy's **toes** had been hurting for several days, and she wanted someone to check them out. She called the clinic to schedule a **toes** examination.
 - c. Amy's **teeth** had been hurting for several days, and she wanted someone to check them out. She called the clinic to schedule a **tooth** examination.
 - d. Amy's **teeth** had been hurting for several days, and she wanted someone to check them out. She called the clinic to schedule a **teeth** examination.

(Haskell et al., 2003, p. 128)

The second task was to rate compounds containing regular plurals and their corresponding singular forms as well as bifurcate pluralia tantum nouns that were semantically matched (e.g. *hammer, hammers, and pliers*):

- (86) a. I last saw Jason in the trousers/ jacket/ jackets section
b. If you're going into the laundry room, make sure you don't mess up the stockings/mitten/ mittens pile
c. Put that back on the pliers/ hammer/ hammers rack
e. Don't forget to sign out whatever you take from the goggles/ flipper/ flippers locker.

(Haskell et al., 2003, pp. 158-159)

The third task was to rate compounds containing voicing-change (VC) plurals and their singular counterparts as well as singular nouns that are semantically matched (e.g. *knife/knives, fork*). A VC plural is semantically and phonologically plural; thus, as a non-head in a compound, it is expected to behave like a regular plural non-head. In the task, the sentences are similar to those in (85), replaced with compounds such as *knife/knives/fork collection*.

Table 2 summarises the overall results of the tests, indicating preference for different modifiers in compounds that are analysed on the basis of phonological and semantic factors (adapted from Haskell et al., 2003, p. 131):

Table 2. Results of tests for preference of different modifiers in compounds.

Example	Semantically plural?	Phonologically plural?	Acceptability
Rat, mouse	No	No	Preferred
Mice	Yes	No	In the middle (marginal)
Scissors	No	Yes	In the middle (marginal)
Wolves	Yes	Yes	In the middle (marginal)
Rats	Yes	Yes	Not preferred

As shown in Table 2, graded effects exist among all forms, with singular forms rated as the most acceptable and regular plurals as the least. Singular nouns were rated as fully acceptable, which in the study was attributed to the non-violation of the semantic and phonological constraints. The participants rated compounds with irregular plurals as partially acceptable, which can be accounted for by the violation of the number constraint. The phonological constraint against the regular plural allomorph is not violated. Irregular plurals ending with the [s] allomorph (e.g. *mice*, *lice*) are not competing with the allomorph that is indicative of the regular plural because the latter is preceded by a voiceless consonant (as in *rats* and *cups*), not a vowel (as in *mice* and *lice*)³⁶. Compounds with bifurcate pluralia tantum non-heads received marginal acceptability. According to Haskell et al., such

³⁶ Three allomorphs indicate plurality: [s], [z] and [ɪz], depending on the final phoneme of the word. If the final phoneme is a voiceless consonant (e.g. *cats*), the choice is the [s] allomorph; if it is a voiced consonant or a vowel, the choice is [z] (e.g. *dogs*); but if the final phoneme is strident, the choice is [ɪz] (e.g. *houses*) (Haskell et al., 2003, p. 140).

nouns are semantically singular, but they violate the phonological constraint against the plural [s] allomorph on modifiers. However, VC plural non-heads did not pattern with regular plurals, although both are similar semantically and phonologically. Haskell et al. (2003, p. 134) pointed out the status of this type of plural is controversial; for Pinker (1999), a VC plural is a sub-type of regular plurals, and in this case the result of the task is problematic because neither type patterned together. A VC plural might be categorised as an irregular plural because the stem is phonologically deformed as a result of pluralisation, for example, *loaf* → *loaves*, in which the final voiceless /f/ changes into the voiced /v/. Moreover, the idiosyncrasy of this type is illustrated by an example like *oaf* → *oafs* in which the stem is kept unchanged. To account for its partial acceptability, Haskell et al. (2003) suggested that a VC plural is an independent type from the regular plural and should be treated as a subclass of the irregular plural, and that is why it patterned with irregular non-heads. Regarding the phonological similarity with the regular plural, Haskell et al. claimed that the constraint has a graded effect; it is stronger against the ordinary regular plural because the stem is not altered due to pluralisation.

Berent & Pinker (2007) and Cunnings and Clahsen (2007) questioned Haskell et al.'s use of the bifurcate pluralia tantum and VC plurals to assess the impact of phonology on the acceptability of modifiers within compounds. The counter-argument is based on evidence from verb attraction errors discussed in Bock & Eberhard (1993), Bock, Eberhard, Cutting, Meyer &

Schriefers (2001), and Senghas, Kim, Pinker, & Collins (1991). Attraction errors refer to “speech errors in which speakers mistakenly select morpho-syntactic features of the most recent phrase to agree with the verb” (Cunnings & Clahsen, 2007, p. 480).

Bock & Eberhard (1993) found that errors are produced more often if the most recent phrase noun is a plural (e.g. **the trap of the rats were...*). Similarly, errors are induced more significantly when the most recent noun is a bifurcate pluralia tantum (e.g. **the advertisement of scissors were...*) (Bock et al., 2001, p. 96) or VC plurals (Senghas et al., 1991). The main point here is that errors induced by ordinary plurals, bifurcate pluralia tantum and VC plurals indicate that all have the same morphological structure [[stem] + [s]] (e.g. [thiev]_N + [-s]_{PLURAL} = [thiev]_N[-s]_{PLURAL}]_N) and, accordingly, their lower acceptability within compounds in Haskell et al.’s (2003) experiments were due to the participants’ sensitivity to morphology rather than phonology (Berent & Pinker, 2007; Cunnings & Clahsen, 2007).

Furthermore, Berent & Pinker (2007) argued that Haskell et al.’s results can be re-interpreted morphologically. First, they observed a considerable number of compounds where the non-heads are in their singular forms but sound like regular plurals, as in (87), yet they are still ‘fully’ acceptable (2007, p. 134).

(87) rose garden, praiseworthy, prize-fight, breezeway, schmooze-fest, Ray Charles record, Mars probe, box-cutter, axe-murderer, Katz paper, Burl Ives concert, Ask-Jeeves user, foxhole, corpse counting, eclipse warning, ellipse formula, synapse recording.

Berent & Pinker (2007) conducted two experiments. In the first, they examined whether their participants would dislike non-head nouns as in (54) above because of their regular plural-sounding familiarity as predicted by Haskell et al. (2003, p. 143): “The phonological constraint should cause such words to be somewhat less acceptable as modifiers as other singulars”. The items were (i) compounds with a non-head that sounds like a regular plural (e.g. *hose-installer*) and (ii) compounds with a singular non-head that is semantically matched (e.g. *pipe-installer*). Each item was presented in a short paragraph, and the participants had to judge how it sounded on a 7-point scale (1 indicating the least acceptable, 7 indicating the most). If Haskell et al.’s proposal is correct, compounds with regular plural-sounding modifiers should be rated as less acceptable. However, the results revealed that they were as fully acceptable as their semantically matched items.

In another experiment, Berent & Pinker (2007, p. 148) included two groups of items: Group 1 - Compounds with a regular plural-sounding modifier (e.g. *hose-collector*) and Group 2 - Compounds with a singular non-head that is phonologically similar to Group 1 but lacks [s] or [z] allomorphs (e.g. *hoe-collector*). Such items were incorporated into stories, and the participants had to read them and rate their acceptability on 1-7 scale (1 as very bad and 7 as excellent). According to the phonological account, the first group should be rated as less acceptable than the second group, i.e. *hoe collector* should be rated higher than *hose collector*. The results, however, showed that both items were rated as fully acceptable.

Berent & Pinker (2007) provided a morphological interpretation for the distinction between regular and irregular inflections in the non-head position within compounds by conducting an additional experiment in which the items were pairs of compounds whose non-heads were homophonous regular and irregular plural non-words, as in Table 3 below³⁷. The items were incorporated into short stories, and the participants had to rate their acceptability.

Berent & Pinker predicted that if a morphological constraint is in operation regular plural non-words (e.g. *breeks*) should be judged as less acceptable than irregular plural non-words (e.g. *breex*); in other words, the participants are aware that the morphological structure of *breeks* is decomposable into (stem + affix) that should not appear in the non-head position in compounds. If a phonological constraint against regular plural-sounding words is in operation, both regular and irregular non-words (e.g. *breeks/breex*) should receive low acceptability.

³⁷ Berent & Pinker's (2007, p. 151) aim of employing non-words was to provide clear evidence of the effect of morphology (not phonology) on the participants' responses, as they claimed, "[b]ecause it is impossible to unconfound these factors perfectly with existing word...".

Table 3. *Examples of homophonous words used in Berent & Pinker's experiment (2007, p.183).*

Regular		Irregular	
Singular	Plural	Singular	Plural
Breek	Breeks	Broox	Breex
Dreek	Dreeks	Droox	Dreex
Sweek	Sweeks	Swoox	Sweex
Sree	Srees	Srooze	Sreeze

The results were again problematic for Haskell et al.'s proposal (2003): regular plurals were rated as significantly less acceptable than irregular plurals despite their phonological similarity³⁸.

A final remark on Haskell et al.'s assumption that speakers' knowledge about the phonological restriction on the first element in adjective-noun sequences could be generalised to impose the same restriction on the first element in noun-noun sequences was refuted by Berent & Pinker (2007, p. 164), who argued that each construction has its distinct features in terms of phonology, semantics, syntax and selectional restrictions that are unlikely to be generalised. Phonologically, they have different stress patterns – initial stress in a compound and final stress in the

³⁸ Nevertheless, Berent & Pinker (2007) were aware that the presentation modality might have yielded such results, which might allow for the possibility that the lowered acceptability of the regular plural is due to orthographic factors (e.g. *gleeks* looks like a regular plural, and *gleex* looks like an irregular plural); consequently, such words were non-preferred. To minimise the effect of orthography on the decision, they replicated the experiment using an aural presentation modality. Similar to the outcomes of the previous experiment, the results showed that regular-sounding non-heads were disfavoured more significantly than their homophonous irregular-sounding non-heads (for detailed discussion, see Berent & Pinker, 2007, pp. 157-166).

adjectival phrase. Semantically, the first element in the adjective–noun sequence functions as a modifier while it can be an argument in compounds (e.g. *rice-eater*). Syntactically, most pre-nominal adjectives can be converted into predicates (e.g. *big boy* → *the boy is big*) whereas non-heads of compounds cannot (e.g. **this eater is rice*). Finally, Berent & Pinker maintained that a restriction on adjectival modifiers exists against the final /s/ or /z/, which could be attributed to the fact that most adjectives end with suffixes like *-ish*, *-able* or *-ive*. However, in the case of non-heads in compounds, such a restriction is not found; indeed, any name ending with any sound can occupy the non-head position in a compound (e.g. *Shevardnadze supporter*). Cross-linguistically, Berent & Pinker observed that phonological properties do not affect the way regular and irregular non-heads are treated within compounds. In German and Dutch, the regular inflection *-s* is avoided, although it is homophonous to the linking morpheme found in compounds (e.g. Clahsen et al., 1992, for German; Collins, 1991, for Dutch).

3.2.2 Processing difficulty

In previous studies (e.g. Gordon, 1985), participants produced irregular plural forms within compounds more often than regular forms. However, Buck-Gengler et al. (2004) claimed that their participants disliked both types inside compounds, but what makes irregular plurals somewhat more acceptable is the factor of processing difficulty.

The relationship between the regular plural form and its singular counterpart is transparent in terms of phonology and orthography, while the singular form is harder to access from its corresponding irregular plural form (e.g. *cars* → *car* is easier than *mice* → *mouse*). The main point here is that the participants in previous studies produced more irregular forms because they faced processing difficulty in converting the irregular plural forms into singulars, while this difficulty vanishes in the case of regular plurals.

Buck-Gengler et al. (2004) conducted two experiments to provide evidence for the effect of processing difficulty. The experiments involved two elicited production tasks to examine the patterns of responses, with time latencies measured in the second experiment. The results showed that the participants produced irregular plurals significantly more often than regular plurals. While measuring production latencies, they found that when participants were presented with an irregular plural, the participants took longer to produce it within a compound.

Moreover, when the irregular plural was successfully converted into the singular when producing it within a compound, the time it took was longer than for any other type of noun, thereby—as Buck-Gengler et al. claimed—confirming the prediction that there is competition between the irregular plural and its corresponding singular noun, with the delay in production being the result of the time needed for the irregular singular to be activated.

Two issues associated with Buck-Gengler et al.'s account are discussed in Cunnings & Clahsen (2007). First, the results did not rule out morphology as a possible constraint, but rather gave an alternative non-morphological explanation. The decomposability of the regular plural noun into stem + affix might have facilitated the exclusion of the affix from compounds. On the other hand, irregular plurals and their corresponding singular nouns are stored in the lexicon; thus, when participants were required to form a compound with an irregular plural, they needed time to retrieve the singular form from the lexicon rather than converting the irregular plural into a singular form. This alternative explanation is further supported by the results of experimental studies in German (e.g. Clahsen et al., 1992). Regular plurals were more significantly excluded from compounds than irregular plurals despite the fact that there is no lack of transparency either phonologically or orthographically between many irregulars and their corresponding singular forms (e.g. *Bauer* 'farmer' vs. *Bauern* 'farmers'), just as with plurals (e.g. *auto* 'car' vs. *autos* 'cars'); hence, transparency in singular-plural relationships has nothing to do with the pattern of responses.

4. THE ABSENCE OF THE REGULAR PLURAL INSIDE COMPOUNDS IS NOT A ROBUST PHENOMENON

In the previous section (§ 3), the absence of the regular plural inside compounds is attributed to a number of constraints: morphological (e.g. Berent & Pinker, 2007; Kiparsky, 1982), semantic and phonological (Haskell

et al., 2003) or phonological and orthographic (Buck-Gengler et al., 2004). The origins of these constraints are distinct; the morphological constraint was proposed within the theories of level ordering and dual-mechanism. Semantic and phonological, and orthographic and phonological, were proposed within connectionism. Proponents of each theory claim that the violation of their constraints will result in ill-formed compounds. For the morphological constraint (Berent & Pinker, 2007; Kiparsky, 1982), a regularly inflected word cannot interact with the rules of compound formation; the regular plural is rule-based and follows the lexical rule of compounding so it cannot feed back into it. The semantic and phonological constraints (Haskell et al., 2003) work together to prevent a regular plural noun from appearing in a compound; failure of either of these constraints will lead to marginal acceptability as illustrated by the partial acceptability of the irregular plural, pluralia tantum and VC plurals inside compounds. With regard to processing difficulty (Buck-Gengler et al., 2004), both regular and irregular plurals violate the default form (a bare modifier + the head noun); however, what makes irregular plurals more acceptable than regular plurals in the experiments is that the mind is very fast to rule out a regular plural noun inside a compound due to the transparent relationship between the singular and its plural in terms of orthography and phonology. In contrast, retrieving the singular noun from its irregular plural counterpart may fail due to the processing difficulty resulting from a non-transparent relationship phonologically and orthographically.

However, I argue that these constraints are not reliable because they were based on a wrong generalisation; hence the constraints failed to impose a robust effect. In (88) below, a number of attested compounds within which the regular plural shows up³⁹:

(88) Enemies list, appliances industry, weapons inspector, drinks dispenser, antiques shop, paintings collection, skills shortage, publications catalogue, buildings inspector, books editor, documents examiner, chemicals industry, explosives production, cereals production.

In addition to the weaknesses with Haskell et al.'s phonological constraint discussed in Berent & Pinker (2007) and Cunnings & Clahsen (2007), compounds in (88) add a serious problem, not only for the phonological constraint but also for the semantic constraint. For example, the plural noun in *publications catalogue* violates the constraint against the allomorph /z/. It is also a non-idiosyncratic plural; the relationship with its singular counterpart is transparent (i.e. *publications* is simply the plural form of *publication*), thus violating the semantic number constraint. The well-formedness of a compound like *publications catalogue* challenges the argument that the violation of the two constraints together will lead to a robust dislike for the regular plural in compounds.

Similarly, examples like those in (88) question a constraint that depends solely on morphology or on the structure of the lexicon. Within level ordering, Halle & Mohanan (1985) and Kiparsky (1982) agreed that the regular inflection should apply at the last stratum of the lexicon based on the

³⁹ They were extracted from Google books corpus.

grounds that the regular inflection can only appear at the end of words, whether derived or underived. The rule of the regular plural suffixation cannot interact with a preceding rule like compounding, a concept shared by proponents of the dual-mechanism theory. The regular plural noun only appears internally if it is formed at stratum 1 (i.e. idiosyncratic), so it is available for compounding at the next stratum (e.g. *drinks* in *drinks cabinet* refers to alcoholic drinks). However, for compounds in (88), the regular plural appears to be real (e.g. in *books editor* the plural form is semantically transparent), questioning the validity of the stratal constraint on such an interaction.

If we put aside the failings encountering the affix-driven stratification previously surveyed in (§ 2.2) for a moment, there would be two possible solutions to address that particular problem. The first is the device of the ‘loop’ like the one suggested in Halle and Mohanan (1985) between stratum III (compounding) and II (Class-II affixes) demonstrated earlier in (§ 2.1). For Kiparsky’s model, this device would operate between stratum 2 and 3, thereby allowing the latter to feed back into the former, as shown below:

- (89) Stratum 1: Class I derivation, irregular inflection
 ↖ Stratum 2: Class II derivation, compounding
 ↖ Stratum 3: Regular inflection

However, this device clashes with the Bracket Erasure Convention suggested in Kiparsky (1982) that imposes the deletion of the internal brackets of morphological constructions at the end of each stratum. It also

must be restricted to forbid the regular plural to appear freely inside compounds and derived forms (e.g., **eventsful*, **dogs lover*).

The second solution is a recursion mechanism. It was originally incorporated by Alegre and Gordon (1996) into Kiparsky's level-ordering model to accommodate the appearance of plural noun phrases inside compounds (e.g., *red rats eater*) in which the noun phrase *red rats* is allowed to go through the levels again and, at stratum 2, can interact with compounding. Similarly, I demonstrate in (90) below, a noun like *appliances* is formed at stratum 3 and then leaves the lexicon to syntax. It is then allowed to gain access through the stratified lexicon. At stratum 2, *appliances* interacts with *industry* via the means of compounding rules, finally forming *appliances industry*.

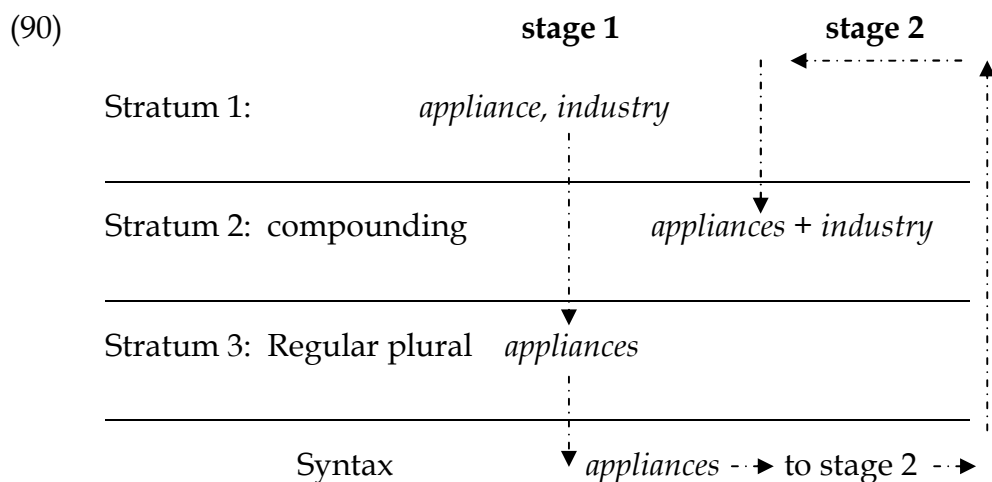

Again, this mechanism should be motivated to restrict plurals to have that second pass. In fact, Alegre and Gordon, in an unpublished manuscript, suggested semantic constraints. I will leave the discussion of this proposal until the end of the thesis (Chapter III, § 5). What is important here is that the

mechanism of recursion cannot be upheld because the theory of level ordering itself is discredited due to the fatal flaws resulting from its affix-based ordering. In other words, the invalidity of the framework will affect the validity of any solution described within it.

As indicated before, the theory of base-driven stratification proves superior to the previous versions of the stratified approach. However, it allows for free interaction by assigning the regular plural and compounding to the same stratum. To overcome this shortcoming, this interaction should be restricted. However, before discussing any constraint, important questions emerge that will be discussed extensively in the next chapter: Is the regular plural formed at stratum 2 or in syntax? If it is in syntax, what mechanism allows for the interaction between a phrase-level affix and a stratum 2 rule like compounding?

5. CONCLUSION

Chapter I started with a discussion of the theory of lexicalism and was compared with a radical alternative theory: Distributed Morphology. It was revealed that a two-system approach is indispensable for capturing the differences between lexical and phrasal constructions. However, I discussed how the sharp divide between lexicon and syntax is unsustainable with the gradience of the phenomenon of compounds, thereby alternatively necessitating a theory of modular overlap. In the base-driven stratificational model, this would occur between stratum 2 and syntax.

In (§ 2), I discussed different stratificational models of English morphology. The base-driven model has proved far superior; it has compellingly addressed the failings associated with the affix-driven models. However, the assignment of the regular plural inflection to stratum 2 along with compounding implies that both rules can freely interact, which is obviously wrong. The BDS model does not propose a specific rule of compounding, so I incorporated Lieber's semantic mechanism to demonstrate later the implementation of the model with respect to the phenomenon in question.

In (§ 3), I reviewed a number of constraints within three theories based on the generalisation that the plural never appears inside compounds unless it is interpreted idiosyncratically. However, as there are attested compounds whose internal non-heads are regularly pluralised, I argued that this is a misleading generalisation and, accordingly, the constraints based on it are questionable. Here the crucial question emerged: What motivates the regular plural to appear inside compounds? This question will be extensively discussed in Chapter III, as it is important for the implementation of the BDS model using Lieber's rule of compounding.

CHAPTER II

THE PLACE OF INFLECTIONS IN THE STRATIFIED LEXICON: EVIDENCE FROM THE POSSESSIVE INFLECTIONS

In the base-driven stratification model (BDS), the regular plural and compounds are formed at the same stratum. However, one of the questions raised in the previous chapter concerns the place of inflections in grammar. In the literature, the theoretical status of inflection is debated. The chapter will discuss three perspectives:

- i. Inflections are formed outside the morphological component (Anderson, 1988, 1992).
- ii. Inflections are formed in the morphological component along with derivations (Booij, 1994, 1996, 1998).
- iii. Unproductive inflections are formed in the morphological component, while productive inflections are formed extra-lexically (Perlmutter, 1988).

The objective of the chapter is to assess the validity of these perspectives. The outcome is important because it might or might not have implications for the theoretical framework adopted in the research and, consequently, on the way the phenomenon of the regular plural inside compound is addressed. For example, if the first or third perspective is borne out, the regular plural will not be formed at stratum 2 where compounding

takes place, and hence a plausible account is required for the interaction between the lexical rule of compounding and the phrasal rule of the regular plural inflection. In contrast, if the second perspective is borne out, the theory of morphology-syntax interface will not be involved, but the gap in the theoretical framework that allows for free interaction between the two lexical rules at the same stratum must be addressed to prevent ill-formed compounds such as **toys factory* and **cities guide*.

Based on evidence from the properties of the possessive affix, this chapter will argue in favour of Booij's lexical approach, thereby defending the BDS model that regular inflections are formed in the lexicon and, more specifically, on stratum 2.

This chapter starts with a review of split morphology hypothesis (SMH) proposed by Anderson (1982, 1988, 1992). He argued that the relevance of inflections to syntax is the criterion, on which his SMH is based (§ 1.1). In (§ 2), Booij's (1994, 1996, 1998) lexical approach will be discussed. His argument in (§ 2.1) is mainly based on the features of distinctiveness between inflection and derivation: productivity and paradigms, semantic transparency, change of word class, obligatoriness, and affix ordering. In (§ 3), I will discuss Perlmutter's theory (1988) that irregular inflections may precede derivation in Yiddish, so he suggested a refinement of Anderson's SMH; only regular inflections are split from the lexicon.

In the rest of the chapter, I argue that the original assumption of base-driven stratification (BDS) should be maintained; both regular and irregular

inflections are formed at their designated strata. This argument is motivated by the possessive affix (§ 4). In (§ 4.1), I will discuss Anderson's theory (2008, 2013) that the possessive marker is a phrase-level affix that is strongly motivated by its appearance at the rightmost constituent of the possessor phrase (e.g. *the King of England's hat*). The second position endorsed by Zwicky (1987), Halpern (1995), and Bermúdez-Otero & Payne (2011), amongst others, is that the possessive is a word-level inflection (§ 4.2). Three kinds of evidence strongly support its status as a lexical affix: (i) the idiosyncrasy of the possessive pronouns (Bermúdez-Otero & Payne, 2011) (§ 5.1); (ii) the sensitivity of the possessive affix to the morphological properties of the host word (Zwicky, 1987) (§ 5.2); and (iii) the appearance of the possessive morpheme inside compounds (§ 5.3).

The chapter ends with concluding remarks (§ 6) on the implications of the chapter for the base-driven stratification model.

1. SPLIT MORPHOLOGY HYPOTHESIS

Anderson has led the debate that inflections should be split from the morphological component and that the interaction between inflections and syntax occurs extra-lexically in the morphosyntactic structure of words rather than in the morphological component. He proposed the structure of grammar sketched in Figure 1.

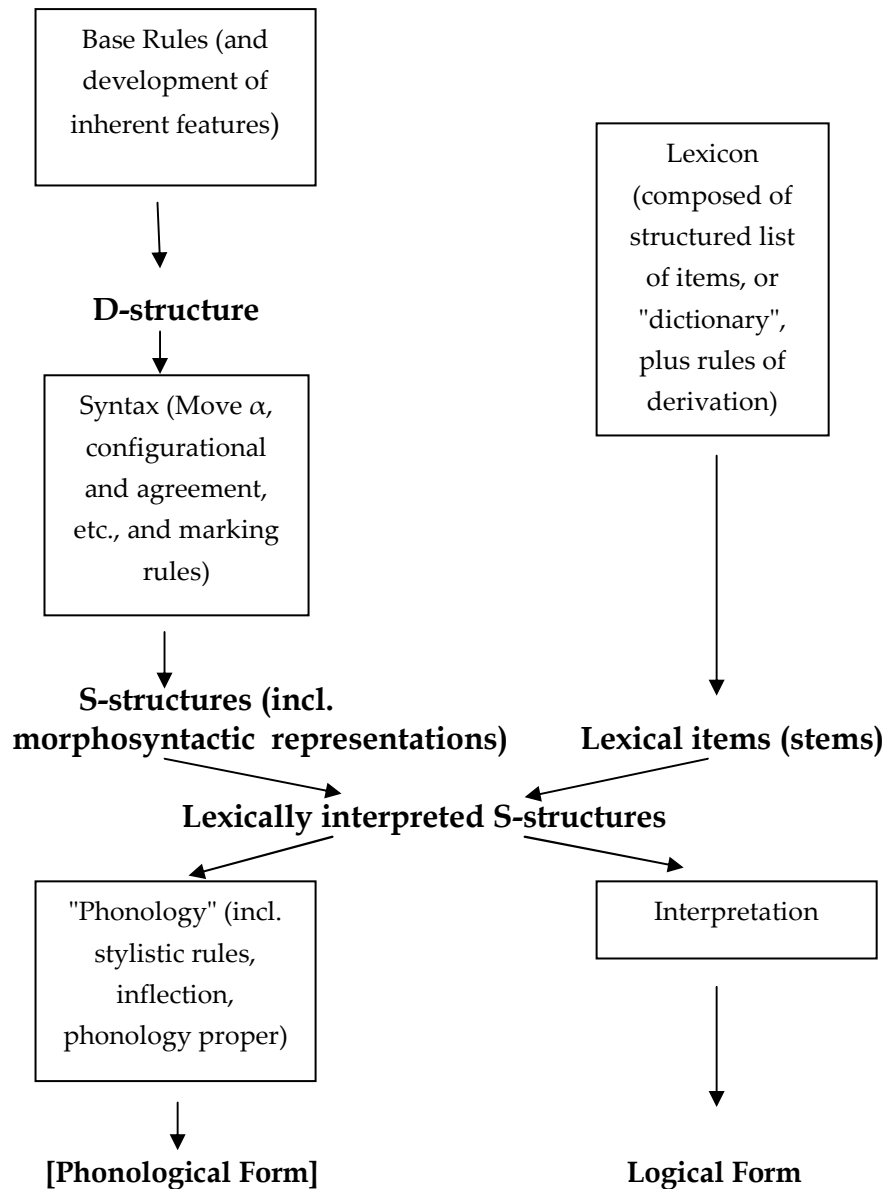

Figure 1. Architecture of grammar (Anderson, 1982, p. 594)

The lexicon is the place for the listed items and derivational rules. They are generated in isolation from syntax, but they are subcategorised to restrict where they appear in the syntactic structure. The rules of the base are responsible for generating lexical categories and the features associated with them; for example, the lexical noun is developed as [\pm Plural] or [\pm gender].

Anderson (1982, p. 592) also proposed the morphosyntactic representation structure defined in (1):

(1) Morphosyntactic Representation Structure (MRS)

The morphosyntactic representation of a word is the only aspect of it that is visible to/in syntax, and the only way the syntax can affect the form of a word is by manipulating its MRS.

He justified this form of interaction that the traditional form is either too weak or too strong. It is too weak because it gives insufficient information about what properties are accessible to syntax. Inflected words are visible to syntax due to their decomposability into stems and affixes; for example, the regular plural morphology *-s* found on English words triggers agreement in the syntactic structure within which it occurs. However, this analysis faces a difficulty because it seems to exclude a significant number of items undergoing non-affixal processes (e.g. apophony, consonant mutation). *Men, children, feet, geese, etc.* have undergone irregular pluralisation, yet they trigger agreement just like regular plurals, questioning how a non-affixal item is visible to syntax when placed in the syntactic environment. Anderson argued that a word must have a different representation that can deal with compositional and non-compositional properties that are relevant to syntax. On the other hand, the actual morphological structure of words might contain too much information about properties that are irrelevant to syntax. One example is the adjective in the Kubachi dialect of the Dargwa language, which can have different kinds of agreement markers: to agree with the gender and number of the noun, initial and final markers are used, whereas

to agree with the number of nouns, a penultimate marker is used. However, these different markers cannot be all exchanged with syntax; only gender and number of the head noun are accessible to the rules of the syntactic component (see Anderson, 1992, pp. 88-89 for detailed discussion).

In the MRS, all information 'encoded' is available for both syntax and morphology. In other words, properties of a word that are not available in MRS cannot be manipulated by syntax.

In the surface structure 'S-structure', the rules supplied by the syntactic component enrich the morphosyntactic representation by assigning further features to create an association between terminal nodes, for example, the association between the terminal nodes of the subject and the verb via means of subject/verb agreement rules. Moreover, in the S-structure, an operation called 'lexical insertion' (or 'lexical interpretation') refers to the process of selecting lexical stems in a phrase marker in accordance with their lexical requirements (e.g. the subcategorisation). The outcome of the association between lexical and morphosyntactic representations is a lexically specified phrase marker.

Inflectional structure is generated in the morphosyntactic representation and to activate the inflectional rules, there should be an interaction between the lexical stem and properties of inflections listed in (§ 1.1) below. The outcome is a lexical stem with abstract features of this inflection, which will finally be sent to the phonological component where the inflection is phonologically realised as an overt element. Here, Stump

(2001, p. 1) differentiated between inflectional realisation in a paradigmatic theory like Anderson's and a lexical theory. In a paradigm-based model, all count nouns should carry the feature number with a feature value singular or plural. A lexeme belonging to a cell with the feature [Numb: Pl] will be realised as a plural form. If the lexeme is in a paradigm with the feature [Num: Sg], the lexeme itself is used as the realisation of that feature since there is no inflection for singular forms. For lexical theories, on the other hand, information is encoded in the lexical entry of the regular plural morpheme that is transferred to the word form to which it attaches.

1.1 Relevancy of Inflections to Syntax

Anderson claimed that the main distinction between inflection and derivation is that the former is relevant to syntax⁴⁰. Following Anderson, Katamba (1993, p. 209) also stated:

Inflectional morphology deals with whatever information about word-structure that is relevant to the syntax. Inflectional properties of words are assigned by the syntax and depend on how a word interacts with other words in a phrase, clause or sentence.

Anderson (1992, pp. 82-83) defined four types of properties of inflections:

a. *Inherent properties*: Some words are inflected to show their inherent lexical characteristics. These properties should be visible to syntax for

⁴⁰ It will be discussed later in (§ 2) that Anderson does not accept the traditional criteria of distinctiveness between inflections and derivations.

agreement purposes. Focusing only on the inherent properties of a noun, we find number and gender. In many languages, the inflection number is normally used to distinguish between one and more than one (e.g. French: *porte* 'door', *portes* 'doors'; German: *haus* 'house', *Häuser* 'houses'). In other languages, there is also an inflection for dual number (e.g. Arabic: *yaddaan* 'two hands'). Number is obligatory in English, but it can also be optional as in East Asian languages (e.g. Japanese: *hón* 'book' or 'books' (Katamba, 1992, p. 233)).

In some languages like French, dependents often agree in gender with their head nouns, as illustrated in (2) below:

- (2) a. un livre vert b. une pomme verte
a.MASC book (M) green.MASC a.FEM apple (F) green.FEM
'a green book' 'a green apple'
(Tallerman, 2013, p. 110)

b. Agreement properties: The inherent properties of a noun are assigned to other words within a noun phrase (e.g. articles, numerals, adjectives) via agreement rules. Compare between the two French examples below:

- (3) a. *La petite fille chante* 'the little girl sings'
b. *Le petit garçon chante* 'the little boy sings'.
(Katamba, 1993, p. 237)

The inherent properties of *fille* (feminine, singular) are copied onto the article *la* and the adjective *petite*. Similarly, in (3b) the masculine and singular properties of *garçon* are assigned to the article *le* and the adjective *petit*; this kind of assignment induces a phonological change in the stem: /pətít/ (fem.) vs. /pəti/ (m.).

generalisation has a substantial consequence for the structure of grammar in Figure 1 above that supports the weaker version of lexicalism; inflection is generated outside the morphological component and, thus, is separated from other categories that are all together believed to constitute the morphological component—namely, derivation and compounding. An important consequence of placing inflections outside the lexicon is that inflectional rules never precede derivational rules: a lexical rule might well presuppose the application of another lexical rule, but it ought not to presuppose the application of a syntactic rule, since such rules could not in principle apply within the lexicon” (Anderson, 1992, p. 41).

2. THE LEXICAL APPROACH TO INFLECTIONS

The second position regarding the theoretical status of inflections is that all inflections are formed in the lexicon along with derivations (e.g.

syntactic. Conversely, if the feature is altered, it is an indication that it is formed in the lexicon. For derivation, the percolation of stem features is interrupted by the change of features that might involve the addition or deletion of features. The result will be an output that differs from its input (Borer, 1984, p. 17):

- (B) i. [enjoy_V] [enjoyable_A]
 category change, case → ∅
 ii. [drop_{Vunacc}] [drop_{Vcause}]
 add case, add ∅-causer
 iii. [inhibited] [uninhibited]
 semantic change

Meanwhile, for inflection, the percolated stem features are preserved at every syntactic level. For example, in [*hit*] → [*hits*], the features of the input and output are the same; both assign case (accusative) and two θ-roles, both are verbs and both have the same meaning (Borer, 1984, p. 17). Nonetheless, although Anderson (1992) agreed with Borer on the syntacticity of inflection, he still questioned whether the projection principle is sufficient for separating inflection from derivation as it does not accurately identify which features of a lexical item should be preserved or lost in syntax. As illustrated in (Biii.), the example of *uninhibited* from *inhibited* involves a semantic change, a criterion previously described by Anderson (1992) as not being sufficient or necessary to argue for the position of inflection and its separation from derivation.

Booij, 1994, 1996, 1998). In the literature, several criteria were traditionally used to draw a sharp distinction between inflections and derivations. Booij (1994, 1996) and Anderson (1992) agreed that any argument in favour of SMH based on these criteria is untenable. For Anderson (1992), counterexamples of inflections behaving like derivation are significant. However, this does not mean that they are formed in the same component. As discussed in the previous section, the relevance of inflections to syntax is the most important criterion supported by the periphery of inflections to derivation.

In contrast, Booij (1994, 1996) argued that the counterexamples to the traditional criteria cannot be ignored because they constitute important evidence that morphology cannot be divided: inflections behaving like derivations comprise a type called 'inherent inflection' and those showing syntactic relevance comprise another type called 'contextual inflections'⁴². The latter type represents the prototypical inflections.

This section argues that although Booij's (1994, 1996, 1998) argument is important; it leaves a gap that opens a possibility for another version of SMH.

⁴² As mentioned in (§ 1.1) above, Anderson defined four properties of inflections: inherent, agreement, phrasal, and configurational; Booij (1994, p. 28) referred to those of the first type as 'inherent inflections' and those belonging to the last three categories as 'contextual inflections'.

2.1 Criteria of Distinctiveness between Derivation and Inflection

2.1.1 Productivity and paradigms

Productivity is often taken as a feature of distinctiveness between inflection and derivation. Inflectional rules are general; they attach to a set of words with the same features. For example, English nouns having the plural feature will take the regular plural inflection suffix. One can say that such words belong to the same paradigm. The feature of paradigms — by which words are grouped into cells that contain information about the inflectional properties of words such as number, person, case and tense — is another way to discuss productivity (Booij, 1998). A word like *house* is assumed to have a zero marker; the underlying structure is *house- \emptyset* , thereby specifying it for a cell having the feature singular SG. Meanwhile, the verb *cleans* has a paradigmatic cell for the features present PRES, third person 3PERS and SG; according to paradigm-based models, the inflection is the realisation of these feature specifications⁴³. Examples of the inflectional paradigm of English verbs are illustrated in (5):

- | | | | | |
|-----|------|-------|--------|---------|
| (5) | walk | walks | walked | walking |
| | love | loves | loved | loving |
- (Katamba, 1993, p. 80)

⁴³ In the case of unmarked nouns (e.g. *book*), the feature [Num: Sg] is inferred on the basis that no similar form can carry a different feature. Models adopting this paradigmatic view are called 'inferential models'. In lexical models, on the other hand, the features are encoded in the lexical entry of the inflectional morpheme; for example, /z/ carries the semantic feature [Number: Pl], which attaches to an unmarked noun (Spencer (2001, p. 280). See Stump (2001) for detailed discussion of inferential models; he argued that they have advantages over lexical models.

Inflectional rules can be generalised to unknown words, which Katamba (1993, p. 80) referred to as 'automatic productivity'. The same observation was illustrated in the previous chapter in Berent & Pinker's experiment (2007, § 3.2) when participants pluralised non-words that sounded like regular nouns by inflecting them with the regular plural suffix (e.g. *sree* → *srees*).

Derivational rules, on the other hand, do not belong to any paradigm due to their unpredictability, which results from their unproductivity; the rules are subject to arbitrary restrictions. Each rule is unique so no rule can be generalised (e.g. *communicate/communication, militate/*militation*); thus, they must be learned (Katamba, 1993, p. 80).

The division between inflection and derivation in terms of productivity is not without exceptions. There are cases in which inflectional rules can be unproductive and derivational rules can be productive.

A derivational rule involving the affixation of *-ly* to English adjectives to form adverbs is productive (e.g. *quick* → *quick-ly*). Another productive rule is the derivational suffix *-ing*, which attaches to verbs to form nouns (e.g. *John's three recent sightings of the yellow-crested titmouse*) (Anderson, 1992, p. 78).

Some inflections like derivation do not belong to paradigms⁴⁴. For example, some English verbs with the past tense feature do not belong to the expected paradigm where other verbs are suffixed with *-ed* (e.g. *go/went, put/*

⁴⁴ They are also called defective paradigms (Anderson, 1982, p. 585).

put). Pluralisation can also be unproductive: (i) irregular inflections (e.g. *oxen*), (ii) some singular nouns having no plural correspondences (e.g. *food*, *courage*, *grace*) and (iii) certain types of nouns lacking singular counterparts—namely, pluralia tantum (e.g. *trousers*, *glasses*) (Booij, 1998, p. 17). Similarly, some Dutch adjectives lack comparative and superlative forms (e.g. *gouden* ‘golden’, *dood* ‘dead’) whereas some superlative forms lack a base (e.g. *onderst* ‘lowest’, *voor-st* ‘most forward’). Plural nouns lacking singular correspondences also exist (e.g. *Alpen* ‘Alpes’, *notulen* ‘minutes’) (Booij, 1994, p. 31). According to Booij, these exceptional inflections are of inherent properties that show similar behaviour with derivation, a phenomenon that challenges SMH.

2.1.2 Semantic transparency

Words resulting from the concatenation of a stem and an inflectional affix will have predictable and regular meaning; inflections affect the meaning, but not the concept (Anderson, 1992, p. 79). In contrast, the output of derivational processes will have a meaning that differs from its input form. Stump (1998, p. 17) stated:

Semantic idiosyncrasy may be attributed to the fact that derivational morphology is located in the lexicon. The fact that the meaning of inflected forms is fully determinate may then be taken as evidence for the syntactic (rule-governed) character of inflectional morphology.

Again, this criterion is not without exceptions; there are examples of derived forms whose meaning does not differ from the corresponding underived forms and also examples of inflected items that are idiosyncratic.

According to Li & Thompson (as cited in Anderson, 1992, p. 79), the suffix *-er* in Chinese was originally a diminutive suffix, which has now no semantic function. It can be seen in different parts of speech in the Mandarin dialect for phonological reasons. In the examples below, *-er* merges with the syllable preceding it to form a new syllable ending in the sound of the suffix:

- (6) niǎo + *-er*: niǎor 'bird'
gēn + *-er*: gēr 'root'
guǐ + *-er*: guǐr 'ghost'

(Li & Thompson, as cited in Anderson, 1992, p. 79)

Some inflections in nouns have become an integral part of their bases. This affects semantic transparency: their meanings cannot be inferred from their constituents. According to Booij (1994), an inherently inflected form may convey a meaning that differs when it is absent—a phenomenon called 'inflectional split', which is not found in contextual inflection. For example, an inflectional split can be found between singular and plural nouns (e.g. *arts, goods, futures, humanities, customs*), but it is not found between singular and plural verbs (Booij, 1994). Similarly, other inherent inflections in Dutch, such as comparatives, superlatives, participles and infinitives, can have non-compositional interpretations.

- | | | | |
|-----|---------------------------|----------------|------------------|
| (7) | a. comparative | beter (better) | 'healthy again' |
| | b. superlative | best (best) | 'good, o.k.' |
| | c. past participle | bezeten | (possessed)'mad' |
| | d. infinitive | eten (eat) | 'food' |
- (Booij, 1994, p. 34)

2.1.3 Change of word class

Derivational affixes are transpositional, which means they change the syntactic category of their host (e.g. *cook* (v.) → *cooker* (n.); *apply* (v.) → *application* (n.)). Inflectional affixes, on the other hand, do not change the word class (e.g. *go* (v) → *goes* (v.)).

When the suffix *-ing* is attached to verbs, the words remain verbs:

- (8)
- a. He was telling the truth
 - b. He told the truth
-
- a. No one saw him leaving the building
 - b. He left the building

If we compare the verbs in (a) and (b) above, we find that they share the same complements.

However, in some cases, suffixation with *-ing* changes the word class into adjectives:

- (9)
- a. He was a charming fellow
 - b. It seemed very interesting
- ((8) & (9) are taken from Huddleston, 1984, p. 318)

Charming and *interesting* are adjectives because they satisfy the following criteria mentioned in Huddleston (1984, p. 319): (i) they occur attributively (e.g. *a charming fellow*, *an interesting person*), (ii) they occur predicatively (e.g. *he looked charming*, *he seemed interesting*), (iii) they follow

the noun they modify (i.e. a postpositive position) (e.g. *someone charming*; *someone interesting*) and they accept the gradable item *very*, which modifies adjectives only (e.g. *he is very interesting*; *he is very charming*)⁴⁵ & ⁴⁶.

Counterexamples also exist in which derivational morphology does not change the grammatical category of the word (e.g. *race* (n.) → *racism* (n.), *president* (n.) → *ex-president* (n.), *man* (n.) → *manhood* (n.)). Scalise (1988, p. 564) suggested that prefixation should not be taken into consideration in this kind of argument. One of the reasons is that the distinction between derivational prefixes and inflectional suffixes biases the outcomes due to the differences in the properties between prefixation and suffixation; the distinction then should be only between derivational and inflectional suffixes. Scalise also argued that derivational suffixation, if it does not change the lexical category of the bases, changes certain features; for example, the rule of the derivational suffix *-hood* changed the features of its base *man* from <-abstract> and <+countable> to <+abstract> and <-countable>. In Italian, Scalise (1988) noted that the derivational rule can also change features in both directions, i.e. from <-count> → <+count> and from <+count> → <-

⁴⁵ Gradable items such as *rather* and *quite* modify both verbs and adjectives (e.g. *I quite like it*; *I'd rather go for it*; *it is quite enjoyable*; *it is rather boring*) (Huddleston (1984, p. 319).

⁴⁶ Cf. *-ing* forms such as *setting*, and *falling*:

- (A) i. He was concerned about the rapidly *falling* share prices
ii. He pointed towards the *setting* sun.

They are verbs: they do not accept *very* (**very setting*, **very falling*), and they do not occur predicatively (e.g. **the sun seemed setting*; **the share prices seemed falling*) (Huddleston, 1984, p. 319).

count>, from <-animate> → <+animate> and from <+animate> → <-animate>.

2.1.4 Obligatoriness

The relationship between inflections and syntax can be more clearly seen through the criterion of obligatoriness; the choice of an inflection is restricted to its place in the syntactic structure. The wrong choice of an inflection or not using one will lead to an ungrammatical sentence; an example from Katamba (1993, p. 206) illustrates the obligatoriness for a match in the number category between the demonstrative and its modifier:

- (10) a. D_{sing}. N_{sing} D_{plur} N_{plur} b. D_{plu} N_{sing} D_{sing} N_{plur}
 this book these books **these book *this books*
 that book those books **those book *that books*

However, the plural marking in Halkomelem Salish is insensitive to syntax (Wiltschko, 2008)⁴⁷. In the examples below, the noun *boy* can be in either its singular or plural form despite being preceded by a cardinal number greater than one:

- (11) a. te Ihíxw swíweles
 DET three boy
 ‘The three boys’
- b. te Ihíxw swóweles
 DET three boy.PL
 ‘The three boys’
 (Wiltschko, 2008, p. 642)

Moreover, the insensitivity of the plural marking in this language is demonstrated by its failure to influence the choice of determiners: both

⁴⁷ Wiltschko (2008) maintained that the plural-marking in this language is not derivational.

singular and plural determiners (*ye* or *te*, respectively) can precede a plural noun:

- (12) a. *t'ílém ye s-í:wí:qe* b. *t'ílém te s-í:wí:qe*
sing DET.PL man.PL sing DET man.PL
'The men are singing.' 'The men are singing.'
(Wiltschko, 2008, 643)

Derivational affixation, on the other hand, is not governed by syntax. The agentive suffix *-er*, for example, is derivational; it is not required that every noun be suffixed with *-er*. A derived word can be replaced with an underived word without affecting the well-formedness of the sentence (e.g. *the farmer in the barn/ the cow in the barn*). Again, this criterion is not sharp enough to draw the distinction. The choice of the suffix *-er* is obligatory in a sentence like *the teacher is in the office* vs. **the teach is in the office*. Similarly, the choice of a derivational suffix like *-ly* that forms adverbs from adjectives is enforced by syntax (e.g., *I opened it awkwardly* vs. **I opened it awkward*) (all examples are taken from Katamba, 1993, pp. 206-207).

2.1.5 Affix ordering

The main evidence for the reliability of SMH is that inflections never precede derivations (Anderson, 1992). Inflections are post-lexical rules; therefore, they cannot feed back into derivational rules (e.g. **productstion*, **eventsful*). In contrast, derived words can be inflected at the phonological component (e.g. *productions*).

Booij (1996) argued that this feature applies only to contextual inflections. They must be peripheral to the derivational affix to be visible in syntax. However, this does not mean that inflections should be separated from the lexicon. Strong evidence against the SMH is that word formation and derivation can be fed with inherent inflections; in the following examples, plural nouns appear inside composites and derivations:

(13) **Composition**

[dak-en]zee 'sea of roofs'
 [huiz-en]rij 'row of houses'
 [held-en]verering 'heroes celebration'

Derivation

[held-en]-dom 'heroism'
 [ploert-en]-dom 'crooks'
 [boek-en]-achtig 'like books'

(Booij, 1996, p. 6)

Another interpretation for the regular plural inflection *-en* inside composites is that it is a linking element. Booij (1996) maintained that it is a genuine regular plural inflection; it has a collective meaning, which might be excluded with the omission of the internal inflection, as illustrated in the pairs below:

- (14) a. stadsraad 'city council' vs. stedenraad 'cities council'
 b. bedrijfswagen 'company car' vs. bedrijv-enterein 'industrial area'
 c. volksbond 'national league' vs. volk-en-bomd 'League of Nations'
 (Booij, 1996, p. 6)

To sum up, Anderson (1988, 1992) claimed that the 'traditional' criteria mentioned herein have failed to demonstrate how inflection is split from derivation as they show discrepancies in behaviour: some cases illustrate that inflections differ from derivations whereas other cases

highlight exceptions in which the categories show similar behaviour. Conversely, Booij (1994, 1996, 1998) convincingly argued that the counterexamples successfully demonstrated that Anderson's (1992) SMH is untenable: inherent inflections have the hallmarks of derivation; they might show relevance to syntax, but they are not dictated by it. The differences between inherent and contextual inflections are also encapsulated in the base-driven stratification. Idiosyncratic inflections behaving like derivation are listed at stratum 1, while productive and semantically transparent inflections are formed at stratum 2. Nevertheless, Booij's (1994, 1996, 1998) conclusion that inflection and derivation are generated in the lexicon is still inconclusive because the striking differences between inherent and contextual inflections open another possibility for Perlmutter's (1988) weaker version of SMH, as discussed in the following section.

3. THE WEAK VERSION OF SMH

Perlmutter (1988) claimed that Anderson's organization of morphology successfully captures the fundamental differences between derivational and inflectional rules; derivational rules refer to the internal structure of lexical entries and they apply before the operation of lexical insertion. Inflections, on the other hand, are associated with the morphosyntactic representation in syntax and are applied after lexical insertion (Anderson, 1992, 1988).

An essential prediction of this theory is that inflections never precede derivation; when two or more suffixes are used, the inflectional suffixes always follow the derivational suffixes (e.g. *mileages* vs. **milesage*). However, Perlmutter observed that in Yiddish this prediction applies to productive inflections, claiming a weaker position of SMH that irregular inflections are formed in the morphological component, while regular inflections are split from it.

In Yiddish, most nouns are pluralized by adding the suffixes *-s* or *-en*. The suffix *-en/-n* is regarded as the more general rule that applies to a large number of nouns (15), whereas the suffix *-s* applies as a specific rule to nouns ending in an unstressed vowel (16):

(15)	Sg	Pl
sea	yam	yamen
blackboard	tovl	tovlen
newspaper	caytung	caytungn
notebook	heft	heftn

(16)	Sg	Pl
gift	matone	matones
war	milxome	milxomes
bride	kale	kales
kingdom	meluxe	meluxes

(Perlmutter, 1988, p. 81)

A diminutive suffix in Yiddish is derivational; the singular forms *-l/-ele* and the plural forms *-lex/-elux*. The following examples conform to Anderson's SMH; plural suffixes do not precede diminutive suffixes:

(17)		Sg	Pl	Pl dim	
	ear	oyer	oyern	oyerlex	*oyernlex
	piece of advice	eyce	eyces	eycelex	*eyceslex
	gift	matone	matones	matonelex	*matoneslex

(Perlmutter, 1988, p. 83)

However, Perlmutter's argument for a weaker version of SMH was based on two cases in which diminutives are formed on plurals:

First: diminutive suffixes attach to 'ablaut stems'. An ablaut stem is a kind of stem suppletion whose sound changes as an indication of grammatical information; the vowel *o* in *cop* ('braid') changes into *e* when pluralized: *cep* ('braids'):

(18)		Sg	Pl	1st dim pl	2d dim pl
	braid	cop	cep	ceplex	cepelex

Second: diminutive suffixes attach to irregular plurals:

(19)		Sg	Pl	Dim pl
	child	kind	kinder	kinderlex
	thorn	dorn	derner	dernerlex

(20)		Sg	Pl	Dim pl
	body	guf	gufim	gufimlex
	pupil	talmid	talmidim	talmidimlex

((18), (19) & (20) are taken from Perlmutter, 1988, p. 80)

According to Perlmutter, the rule underlying the formation of plural nouns with the suffix *-er* and *-im* are unsystematic. For the suffix *-im*, its rule looks regular; that is, the concatenations of the stem *guf* and the suffix *-im* do not involve changes in the stem. However, in the following examples *-im* is an irregular inflection:

(21)		Sg	Pl
	a. thief	ganef	ganovim
	fool	nar	naronim
	b. hospitable person	maxnes-oyrex	maxnise-orxim
	only son	ben-yoxed	bney-yexidim
	c. villain	roše	rešoim

(Perlmutter, 1988, p. 90)

Perlmutter's (1988) approach to inflection is that irregular plurals and ablaut stems of nouns are unproductive rules that should be listed in the lexicon; they are allowed to precede derivation suffixes such as diminutives. Regular inflections, on the other hand, are phrasal-level affixes that are prohibited from feeding back into derivational affixes.

The outcomes of the previous discussions are as follows:

Anderson's (1982, 1992) SMH was impossible to defend and was discredited by the two other approaches. Booij (1994, 1996, 1998) demonstrated that the split between processes sharing similar properties is wrong⁴⁸. Perlmutter (1988), on the other hand, observed that irregular

⁴⁸ Note that Bermúdez-Otero & Payne (2011) observed that Anderson's organization of morphology in his most recent book (2005) is significantly different from the structure proposed previously (1992, 1982). The new proposal is that an inflection is a product of lexical morphophonology, hence a word-level inflection; it is sketched in (B) below:

(B)	Lexical morphophonology	controls the distribution of affixes
	Syntax	controls the distribution of words
	Postlexical morphophonology	controls the distribution of special clitics.

(Bermúdez-Otero & Payne, 2011, p. 5)

This contradicts his original theory (1982, 1992) that inflections are not formed in the lexicon; they are phrasal-level formed by means of post-lexical morphophonological rules. Bermúdez-Otero & Payne (2011, p. 13) stated:

Anderson (2005) ignores the Split Morphology Hypothesis: we have found no reference to it in the book at all, and it is directly contradicted by the statement cited above that "words are built (including affixation) within the lexical phonology" and "words are

inflections might precede derivations, hence suggesting a weaker version of Anderson's (1982) theory. The section has revealed that differences between inherent and contextual inflections did not rule out SMH entirely because Perlmutter's approach is still tenable. The separation of contextual inflections from the lexicon means that they are insensitive to the morphological properties of their host words and should not show up within compounds. However, the strongest case for Booi's lexical approach would be an inflectional form that can be either grammatical or lexical (Acquaviva, 2008). The possessive affix is an example of this kind of inflection. For the rest of this chapter, I will discuss the lexical properties of the possessive affix arguing that contextual inflections should not be separated from the lexicon and, consequently, within the BDS model the regular plural is correctly assigned with compounding to stratum 2.

4. THE POSSESSIVE AFFIX: CLITIC AND LEXICAL ANALYSES

The possessive affix (POSS-S)⁴⁹ has received two different analyses: (i) a clitic (supported by Anderson, 2008, 2005, 1992; Carstairs-McCarthy, 2002; Katamba, 1993; Quirk, Greenbaum, Leech, & Svartvik, 1985) or (ii) a lexical affix (supported by Bermúdez-Otero & Payne, 2011; Payne, 2009; Halpern,

combined with one another post-lexically, through the syntax (Anderson 2005: 33-34)".

Anderson (2005) did not justify this dramatic change. My argument about his position with the place of inflection will relate to his in 1992, 1988, 1982.

⁴⁹ The abbreviation is taken from Denison, Scott & Börjars (2010).

1995; Miller, 1992; Lapointe, 1990; Zwicky, 1987)⁵⁰. Both analyses agree on the phrasal property of POSS-S, particularly its appearance as the rightmost constituent of the possessor phrase (e.g. *the king of England's hat*), but they diverge on the place of its realisation, at the lexical or post-lexical level.

First, in (§ 4.1 & § 4.2), I will review some of the mechanisms proposed for the realisation of POSS-S at phrasal and word levels. Note that the aim of that section is not to propose a refinement of a specific mechanism, but rather to serve as a preliminary section that I will refer to occasionally when discussing the supporting evidence for the lexical status of POSS-S.

In (§ 5.1, § 5.2 & § 5.3), I will discuss three kinds of evidence for the lexical status of POSS-S: (i) the idiosyncrasy of the possessive pronouns, (ii) Z haplology and (iii) possessive compounds, respectively.

4.1 POSS-S as a Clitic

The genitive has two distinct types: head genitive when the marking appears on the head of the phrase and phrasal genitive when the marking appears as the rightmost item of the possessor phrase (Payne & Huddleston, 2002, p. 479):

⁵⁰ Different terminologies have been used for both analyses; e.g. Anderson (2008, 2005) used 'clitic', 'phrasal affix', 'phrasal-level affix', 'special clitics'; Zwicky (1987) used 'phrasal affix' or 'word-level affix'; Bermúdez-Otero & Payne (2011) and Payne (2009) called it 'lexical affix', while Halpern (1995) used 'lexical clitic'. For consistency, I will use the terms 'clitic', 'phrasal affix' or 'phrasal-level affix' referring to Anderson's treatment of the POSS-S and 'lexical affix' or 'word-level affix' referring to a treatment in favour of its attachment as a lexical element (e.g. Bermúdez-Otero & Payne, 2011; Halpern, 1995; Zwicky, 1987).

- (22) a. [Edward's] daughter
a. [everyone's] responsibility
a. [somebody's] initiative
a. [the doctor's] house
- b. [the king of England's] daughter
b. [everyone else's] responsibility
b. [somebody local's] initiative
b. [a guy I know's] house

The use of the phrasal genitive is informal and found in spoken more often than written language⁵¹. In particular, it has resulted in controversy over its locus of realisation, at the lexical or post-lexical level. According to Anderson (2005, 1992), POSS-S should be analysed as a special kind of clitic rather than an affix.

Clitics in general have corresponding full forms (e.g. *n't* is a reduced form of the negative word *not* that attaches to auxiliary verbs such as *isn't*, *shouldn't* and *mightn't*; the item *'ve* is a contracted form of the verb auxiliary *have* that attaches to pronouns, such as *we've*, *you've* and *I've* (Radford, 2006, p. 237)) and, in this case, Anderson (1992) and Katamba (1993) called them simple clitics. A simple clitic refers to the contracted morpheme that takes the same position and syntactic function of its corresponding full form (e.g. *they have gone* = *they've gone*; the simple clitic *'ve* takes the same position and role of the full form *have*) (Katamba, 1993, p. 246). The characteristics of POSS-S,

⁵¹ According to Payne & Huddleston (2002, p. 479), the length of post-modification affects the acceptability of the phrasal genitive; the longer it is, the less acceptable it will be:

- (C) i. a. [the Head of Department's] speech
b. ?[the Head of the newly formed Asian Studies Department's] speech
ii. a. [the man she was speaking to's] reaction
b. ?[the man that her friend had been complaining to's] reaction
c. *[the man she and her friend had been complaining to so angrily's] reaction

Denison et al. (2010) conducted a corpus-based study that showed that the phrasal genitive is extremely rare even in spoken language, hence questioning theories based on this phenomenon.

however, do not fully match those of simple clitics; Zwicky (1977, p. 1)

describes POSS-S as a morpheme with 'analytical difficulty':

Most languages—very possibly, all except for the most rigidly isolating type—have morphemes that present analytic difficulties because they are neither clearly independent words nor clearly affixes.

Zwicky & Pullum (1983, pp. 503-506) proposed six features of distinctiveness between clitics and affixes:

A. "*Clitics can exhibit a low degree of selection with respect to their hosts, while affixes exhibit a high degree of selection with respect to their stems*": As illustrated by the examples in (23), clitics may attach to words of any category (e.g. preposition, verb, adjective, adverb), thereby limiting the word's capability of selectiveness.

(23) a. Preposition

The house Marie was born in's (= in has) been demolished.

b. Verb

The jug she sent's (= sent is) lovely.

c. Adjective

Any minister that is corrupt's (=corrupt is) going to be sacked.

d. Adverb

All the drivers who are paid weekly've (=weekly have) been given a pay rise.

(Katamba, 1993, p. 247)

The low degree of selection might be restricted to speech rather than writing; in writing, for example, the clitic attaches to the subject noun or pronoun (e.g. *Jack's left* 'jack is/ has left; *he/ she'd left* 'he/she had left') (Katamba, 1993, p. 247). Meanwhile, inflectional affixes are not free to attach to any host; for example, the plural marker *-s* attaches only to noun hosts,

the past tense marker *-ed* attaches only to verb hosts and *-est* attaches only to adjectives (Katamba, 1993, p. 246).

B. “Arbitrary gaps in the set of combinations are more characteristic of affixed words than of clitic groups”: According to Zwicky & Pullum (1983), the attachment of a clitic to a host word regardless of its word class in the relevant domain does not fail in general, although inexplicable exceptions exist for some inflectional affixes in which they do not attach to a particular host (e.g. the past simple inflection *-ed* fails to attach to some verbs such as *cut* and *break*; some nouns lack the overt number inflection, such as *sheep* and *fish*).

C. “Morphophonological idiosyncrasies are more characteristic of affixed words than of clitic groups”: The output resulting from the concatenation of noun stems and the regular plural inflection can be either the regular form (e.g. *cars*, *houses*, *trees*) or an idiosyncratic morphophonological form (e.g. *oxen*, *children*, *went*, *slept*). Clitics, on the other hand, are subject to the rule of voice assimilation (Katamba, 1993).

D. “Semantic idiosyncrasies are more characteristic of affixed words than of clitic groups”: Clitics do not affect the semantic transparency of their host words. The semantics of two sentences, one with the contracted form of an auxiliary and the other containing its corresponding full form, are identical and share the same meaning (e.g. *she's come* has the same meaning expressed in *she has come*). On the other hand, semantic idiosyncrasies are common in the case of inflectional affixes; for example, the word *last*—which was

originally the superlative form of the word *late*—has a non-compositional meaning: *final* (Zwicky & Pullum, 1983, p. 505).

E. “*Syntactic rules can affect affixed words, but cannot affect clitic groups*”: According to Zwicky & Pullum (1983), a word-affix combination is regarded as a syntactic single unit, unlike the word-clitic combination, which is seen as two separate items under syntactic operations.

F. “*Clitics can attach to material already containing clitics, but affixes cannot*”: The clitic *'ve* can attach to another cliticised word. Inflectional morphemes, on the other hand, cannot attach to words ending with a clitic.

- (24) a. I'd've brought some for you, if I'd known
b. *I'd've -ing brought some for you, if I'd known
(Katamb, 1993, p. 248)

Anderson (2005, p. 33) claimed that these features are derivable as ‘theorems’ from his theory of ‘special clitics’; a special clitic is neither a phonologically deficient word like ordinary clitics nor an affix, and it is governed by ‘special rules’, namely, by the postlexical morphophonological rule in (25) below.

(25) English [POSS] realisation

Phrasal Morphology: Adjoin /z/ to the final syllable of a DP bearing the feature [+POSS].

First, Anderson proposed that the possessor phrase occupies the position of specifier of DP. The possessum N constitutes an NP within D' whose head D is phonologically null, thus ruling out examples like **John's the book*. The feature of the English possessive [POSS] creates a relationship between the whole phrase representing the possessor and the nominal

expression representing the possessum by its assignment to the possessed phrase in Spec (DP), which can be represented in the following rule (Anderson, 2008, p. 3):

(26) English possessive (Morphosyntax):

DP → [+POSS]/[_{DP}−] D X]

(27) The king of France's wig

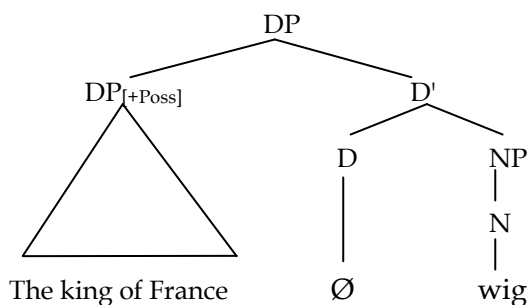

The mother node DP branches into Spec (DP) occupied by *the king of France* and D' within which NP *wig* adjoins the phonologically null head; by means of the rule in (26), the phrasal feature [+POSS] is assigned to the possessor DP, which is then realised by the rule of phrasal morphology in (25) by adding the allomorph /z/ to the end of the phrase [ðə kɪŋ əv fræns]. However, this rule does not admit the relationship between /z/ and the last syllable of the host, so the amendments into [(fræn)_o(siz)_o] by inserting an epenthetic vowel occur at the post-lexical level.

4.2 POSS-S as a Lexical Affix

Bermúdez-Otero & Payne (2011) refuted Anderson's analysis, arguing that there is nothing special about the possessive that warrants analysing differently from other word-level inflections. Regarding the properties of

affixes and clitics listed in the previous section, Bermúdez-Otero & Payne noted that Zwicky & Pullum's properties (E) and (F) support Anderson's theory of the sharp demarcation between lexical and phrasal rules. However, the other properties (A, B, C) are gradient; Zwicky & Pullum (1983) themselves made it clear that these criteria do not completely separate affixes from clitics. Bermúdez-Otero & Payne (2011, p. 13) cited the following quotation:

Interestingly, whereas Anderson (2005: 34) asserts that Zwicky and Pullum's (1983) criteria for distinguishing between affixes and clitics follow as "theorems" from (2), Anderson (1992: 223) merely claims that Zwicky and Pullum's criteria are "quite compatible" with a split-morphology architecture, ... However, even at this point, Anderson (1992: 223) equivocates, for he suggests that the key fact behind the clitic-affix distinction, as drawn by Zwicky and Pullum, is that "words, not phrases, are what appear in the lexicon"; but in a split-morphology architecture like that of Anderson (1982: 594, 1992) the lexicon builds lexemes (or stems), not words.

On the other hand, Zwicky (1987) argued that POSS-S is a lexical affix.

His proposal is that the specification [POSS] appears on the top node of a possessive NP, based on the rule depicted in (28) below:

(28) $NP \rightarrow NP[POSS], N'$

Here [POSS] is described in (29):

- (29) a. The feature must appear on a mother category if it appears on any daughter category.
b. The feature can occur on no more than one daughter category.
(Zwicky, 1987, p. 136)

Moreover, [POSS] cannot appear on any daughter node dominated by NP[POSS] because, according to Zwicky, it is conditioned by the feature

[LAST] enforced by the rule of linear precedence (LP) in (30)⁵²; consequently, the lexical item marked with the possessive inflection must follow all of its sisters.

(30) 'By the rule of LP' $X < [\text{LAST}]$

The realisation of POSS-S is illustrated in the following tree diagram:

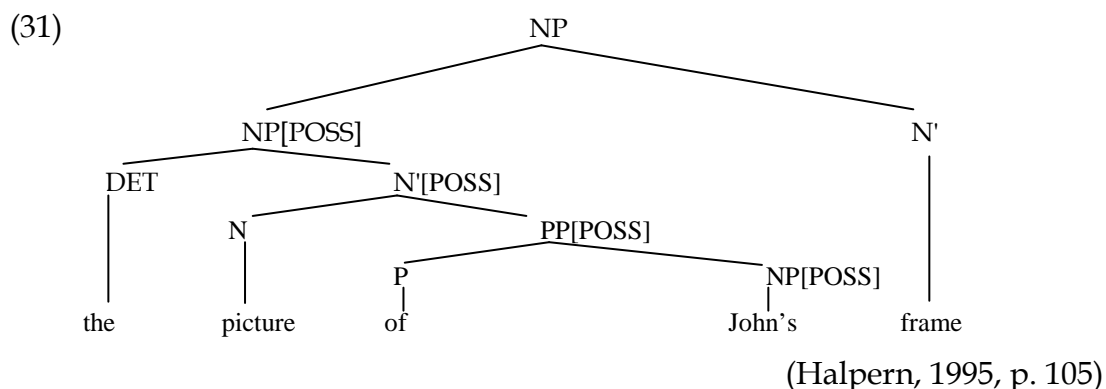

However, the condition on [POSS] is questioned by Lapointe (1990) and Halpern (1995). First, by enforcing X 's to follow all of its sisters, this would wrongly allow for a construction like **hat John's* (Halpern, 1995, p. 106). Second, in coordinated structures, [POSS] can appear on a set of sisters (e.g., *Sue's, Mary's, and John's mother*), hence violating the condition that [POSS] should only appear on the last of a set of sisters. Third, Zwicky's analysis faces a clashing problem in the case of a possessive construction embedded in another possessive construction (e.g., *my friend's dog's bone*). A daughter associated with [POSS] in each construction needs to be the last (Halpern, 1995, p. 107):

⁵² The linear precedence rule LP is a type of Generalized Phrase-Structure Grammar GPSG rules that takes the format $X < Y$ 'i.e. X must precede Y ' in a left-to-right order (Crystal, 2011, p. 282).

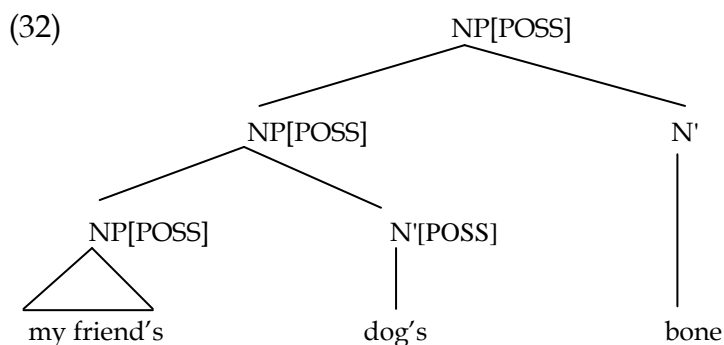

To overcome some of these problems, Lapointe (1990, p. 231-232)

suggested the edge feature convention in (33):

(33) The Edge Feature Convention (EFC):

An instantiated EDGE feature can appear on a daughter node only if the feature appears independently on the mother node and one of the following two conditions holds:

a) the daughter node is the rightmost one, if the feature is LAST EDGE (or the leftmost one, if the feature is FIRST EDGE) or

b) the mother node has multiple head daughters, the daughter node is one of those head daughters, and the feature appears on each of the other head daughter nodes as well.

As (33a) suggests, the presence of [POSS] on either the rightmost or leftmost daughter depends on whether the edge feature is LAST or FIRST, respectively; (33b) stipulates that POSS-S appears on more than one daughter if it occupies the head position, as in the case of coordinated structures. However, EFC would allow for a construction such as **the mother of John's and Mary's new husband is named Mark*; *John's and Mary's* occupy two head daughters of a mother node NP[POSS] and—according to Lapointe's proposal—the possessive marking is licensed to appear on both daughters (Halpern, 1995). In addition, Halpern noted some problems with Lapointe's EFC regarding possessive pronouns and double marking—a problem for

which Zwicky's proposal also fails to provide an explanation (e.g. *a friend of Mary's phone number* vs. *a friend of mine's phone number*). Miller (1992) and Halpern (1995) provided a more refined version of Lapointe's EFC to address such problems by incorporating two features: trigger and marking features. I will return to these features in the following section when discussing the idiosyncrasy of possessive pronouns.

To sum up, the phrasal properties of a possessive morpheme have been taken as evidence for the non-lexical status of inflections; the possessive morpheme attaches to words as well as phrases (e.g. *the king's hat* and *the king of England's hat*). Therefore, it is a clitic rather than a lexical affix (Anderson, 2008, 2005). On the other hand, theorists arguing for the lexical position of the possessive have stipulated a number of mechanisms to accommodate the fact that a possessive has phrasal properties (e.g. linear precedence, edge feature, trigger and marking features) (Halpern, 1995; Miller, 1992; Lapointe, 1990; Zwicky, 1987). The realisation of the possessive affix as a lexical inflection is in fact based on three kinds of evidence that call Anderson's phrasal account into question: the idiosyncrasy of possessive pronouns, the sensitivity of the possessive morpheme to the properties of the host to which it attaches and, more controversially, the appearance of the possessive morpheme inside compounds.

5. POSSESSIVE AFFIX IS NOT PHRASAL

5.1 Idiosyncrasy of Possessive Pronouns

The possessive pronouns that appear in the head position are idiosyncratic:

(34) my lunch, your lunch, her lunch, our lunch

Anderson's [POSS] realisation rule in (25) above makes an incorrect prediction: [POSS] is realised by adjoining /z/ to pronouns as illustrated below:

(35) *I's/me's, *you's, *she's/her's, *we's/us's lunch

However, for pronouns appearing at the edge of the possessive phrase, it seems that Anderson's phrasal morphology rule applies:

(36) a. woman who loves me's bad habit
b. a friend of mine's bad habit

((35) & (36) are taken from Anderson, 2013, p. 206)

The failure of the phrasal morphology rule to apply to plain pronouns in the head position would imply a different rule; indeed, the only option for Anderson (2008) to defend his theory was to resort to lexical morphology, a treatment described as 'schizophrenic' by Bermúdez-Otero & Payne (2011, p. 26), that is, the phrasal morphology rule for pronouns appearing at the edge of the possessive phrase and the lexical morphology rule for suppletive possessive pronouns in the head position. Anderson (2008) pointed out that "their shape, that is, seems to be determined as a lexical matter, which is a kind of thing we associate with word level inflection rather than phrase level clitics" (p. 8).

According to Anderson, possessive pronouns are listed in the lexicon; they cannot be derived from rules due to their idiosyncratic forms. In the syntactic structure, they appear as a non-branching member of a 'lexicalised' DP that carries features such as person and number:

(37) my: [DP,+Poss[D +ME, -YOU, -PL]]

The DP bearing [POSS] is lexicalised by these forms of pronouns, whose idiosyncratic status (which is a specific rule) consequently blocks application of the general rule at PF by the principles of 'elsewhere condition' and 'blocking', suggested by Kiparsky (1973) and Aronoff (1976), among others.

However, Anderson (2008, p. 9) observed that his solution of 'a special kind of Determiner' does not always work:

- (38) a. *These's illustrations are more competently drawn than those's
b. *Of the books I lent you, two's/some's/many's covers were soiled
when you brought them back)
c. ...one's cover was soiled

Two, *some* and *many* are non-branching D just like idiosyncratic possessive pronouns, but their DP cannot associate with [POSS], thus accounting for the ungrammaticality of (38a & b). Making it more mysterious within this solution is that *one*, on the other hand, accepts the possessive affix. Anderson acknowledged that a gap exists in the analysis, and it should be filled with 'further principle(s)'.

Irregular possessive pronouns have also been addressed within the analysis of POSS-S as an edge inflection. According to Zwicky (1987), [POSS]

appears on all the nodes on the right edge of the possessive NP, and the suppletive form will be inserted if the rightmost terminal node carries a feature specific for a suppletive form (e.g. NP[POSS, PRO: +, PERS: 1, NUM: pl] → our), illustrated in the diagram below:

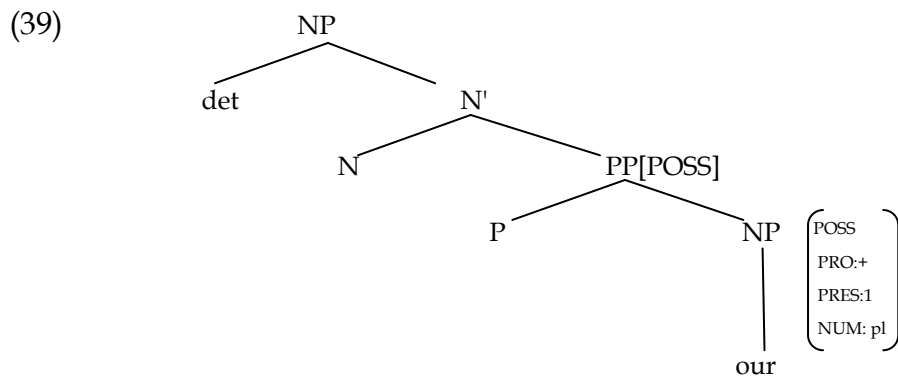

On this account, all other forms are ruled out; for example, the account does not recognise a situation in which the possessive affix attaches to suppletive pronouns, wrongly ruling out a structure like *a friend of mine's phone number*. The analysis mispredicts that the underlined forms in (40) below should be first person pronouns.

- (40) a. *[my brother and my] book
 b. *[the man who hit my] fist
 c. *[the picture of our] frame
 (Halpern, 1995, p. 109)

Within edge theory, a number of proposals have addressed the problem of possessive pronouns; I will mention Miller (1992), who incorporated two features: 'trigger' and 'marking':

- (41) **The Edge Feature Principle (EFP):**
 For a pair of features F and G, such that F is a trigger feature and G is the associated marking feature,
 a. if F appears on the mother in a local tree, G must appear on one of the daughters.

- b. If G appears on the mother in a local tree, it must appear on one of the daughters.
- c. If G appears on a daughter in a local tree, either F or G (or both) must appear on the mother.

(Halpern, 1995, p. 112)

According to EFC in (41a), the phrasal node bearing a trigger feature will percolate an associated marking feature to one of its daughters. In (41b), if the latter node branches, its marking feature must also be percolated to one of its daughters, and so on. In (41c), the series of percolations does not land on any node; the node must be dominated by trigger or marking features. The upward percolation stops once it reaches the dominating node displaying the trigger feature (Halpern, 1995, p. 112).

Miller (1992) proposed POSS for the trigger feature and PM for the marking feature. The former is established by grammar, and the latter is the morphological realisation on the lexical item. The percolation of the features is illustrated in the two diagrams below:

(42)

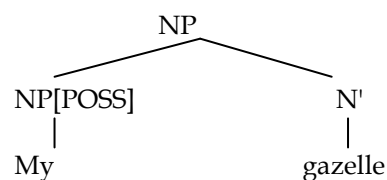

(Halpern, 1995, p. 113)

In (42), since *my* does not take the possessive marking, POSS associated with NP will not lead to PM (cf. **my's gazelle*); it is realised directly as a suppletive pronoun.

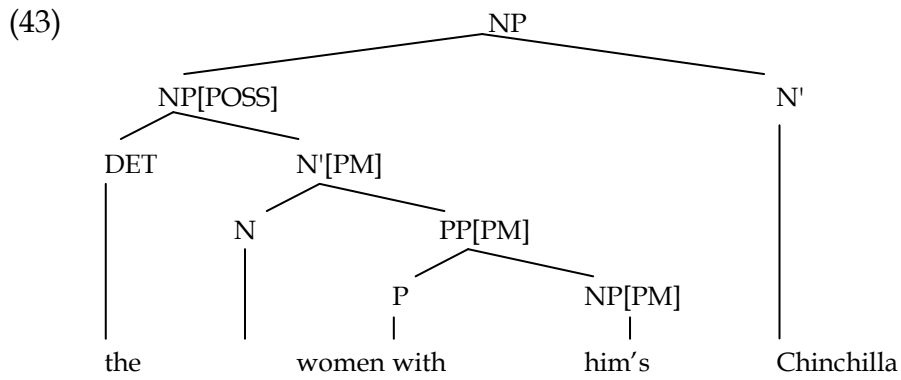

(Halpern, 1995, p. 114)

For pronouns marked with POSS-S as in (43), the trigger feature is introduced on the top node of the possessive construction NP, which percolates PM down to N', which is in turn percolates PM down to PP. PM eventually reaches the lexical item *him* on which it is realised as an overt marking.

To sum up, Anderson proposed a non-straightforward solution to deal with possessive pronouns; a set of pronouns is subject to phrasal morphology, while another set is subject to lexical morphology. Lexical morphology, however, is capable of dealing with both sets without resorting to postlexical morphophonological rules, as Bermúdez-Otero & Payne (2011, p. 26) pointed out:

Rather than split the realization of the genitive into two subsystems of lexical and phrasal morphology, it seems simpler to us here to maintain one system of lexical morphology, with lexically listed irregularities and exceptions.

5.2 Z Haplology

Z haplology is the second phenomenon that invalidates the theory that contextual inflections are phrase-level rules. Zwicky's (1987) argument against a syntactic analysis of the possessive comes from the fact that the possessive is suppressed or lost entirely if the host word ends in three homophonous morphemes: the regular plural, the regular third-person singular present tense or the possessive. The crucial point is that the sensitivity of the possessive marker to the morphological structure of the host presents compelling evidence that the operation of attachment is performed in the lexicon. Halpern (1995, p. 99) concurred with Zwicky: "As a rule of thumb, neither the distribution nor the shape of a clitic is sensitive to the morphological characteristics of its host".

5.2.1 Zwicky's (1987) observation and analysis

The possessive has three regular allomorphs, /s/, /z/ and /ɪz/, whose distribution is governed by the phonological properties of the host word: (i) /s/ is selected if the word ends in a non-sibilant voiceless consonant (e.g. *cat's*), (ii) /ɪz/ is selected if the word ends in voiced or voiceless sibilant (e.g. *judge's*, *boss's*) and /z/ is selected elsewhere (Spencer & Luis, 2012, p. 127).

Zwicky (1987), however, noted that all of the three allomorphs are subject to reduction to a single /z/:

- (44) a. the dogs'/*dogs's kennel
b. the cats'/*cats's favourite places
c. the crocuses'/*crocuses's bright blossoms

This phenomenon is also called 'Z haplology' (Halpern, 1995) or 'suppressing the Zs' (Zwicky, 1987); it occurs in three conditions.

First, the possessive is suppressed if it follows a noun ending in a regular plural suffix:

(45) the two kids'/*kids's ideas, a friend of the two kids'/*kids's⁵³

Payne (2009, p. 326) also observed that the plural possessive is reduced to a single token of /z/ in two cases: (i) on common nouns with the Latinate or Greek ending /s/ (e.g. *indices'*) and (ii) on common nouns with a homophonous plural ending for both singular and plural forms (e.g. *species'*).

Second, the possessive also fails to attach if the host word ends in a regular third-person present inflection, as illustrated in (46d):

- (46) a. people who hurry's ideas
b. people who are hurrying's ideas
c. everyone who hurried's ideas
d. anyone who hurries'/*hurrie's ideas

Third, the possessive is also suppressed with the presence of other possessive markers, as in (47):

- (47) a. a friend of my two kids' / *kids's/ kids's's ideas
b. an acquaintance of the people at the Smiths' / *Smiths's/
*Smiths's's/ Smiths's's's crazy ideas

For 'multiple suppression' in (47a), two kinds of possessive are suppressed by the regular plural morpheme: the doubled possessive (**of my two kid's's*) and the prenominal possessive (**of my two kids's's ideas*). The example in (47b) illustrates three kinds of possessive, all of which are

⁵³ All the examples in this section are taken from Zwicky (1987, p. 140).

suppressed due to the presence of the regular plural on *Smiths*: one refers to the locational possessive (**at the Smiths's*) while the other refers to the doubled possessive (**of the people at the Smiths's*) and the third refers to the prenominal possessive (**of the people at the Smiths's's's crazy ideas*)⁵⁴.

Z haplology is not affected by location, whether it occurs on the head noun as in (44) above or at the edge of the possessive phrase as in (48):

- (48) a. anyone who likes kids'/*kids's ideas
b. people attacked by cats'/*cats's reactions to them

According to Zwicky (1987), the fact that POSS is suppressed by other Zs calls into question the analysis of the possessive affix as a syntactic element. Assuming that the possessive marker is a syntactic constituent, it should have a lexical entry that contains information about its representations. Its phonological representation would be subject to the following principle in (49) (Zwicky, 1987, p. 141):

- (49) POSS has the lexical phonological representation /z/, UNLESS its host ends in a morpheme /z/.

However, the unless-clause raises two problems with the syntactic analysis of the possessive marker. According to Zwicky (1987), the principle

⁵⁴ For the syntactic distribution of the possessives in *an acquaintance of the people at the Smiths*, Zwicky (1987, p. 146) suggested that the NP node *the Smiths* carries the feature LAST: POSS (denoting the locational possessive) whereas the NP node *the people at the Smiths* carries the feature LAST: POSS (denoting a doubled possessive). However, the larger NP node *an acquaintance of the people at the Smiths* carries the feature LAST: POSS, which denotes the prenominal possessive. Within Nevis's framework of generalised phrase-structure grammar (GPSG) (as cited in Zwicky, 1987, p. 136), the requirements of the three instances of POSS having the same feature LAST are satisfied by the rules in both (29) and (30) above; the realisation of POSS at the edge of the phrase is subject to the condition of immediate dominance (ID) in (29a) and the feature in (29b). The latter is enforced by the rule of linear precedence (LP) in (30). Thus, one feature [LAST: POSS] satisfies the three kinds of POSS.

seems to interfere with the internal structure of the host, which is impossible for a syntactic formative. The principle also assumes that the POSS allomorph is deleted by the plural allomorph, which is questionable as no syntactic formatives can be deleted by any rule.

Moreover, Zwicky (1987) dismissed the possibility that the phonological properties of lexical items account for this phenomenon based on two kinds of evidence. First, the possessive is not reduced after singular possessive nouns ending in allomorphs that are homophonous to the regular plural:

- (50) a. the fuzz's old cars; at Buzz's
b. the bus's doors; at Cass's
c. the terrace's tiling; at Thomas's

Second, the possessive does not fail to apply after irregular plurals that happen to end in an allomorph identical to the regular plural (e.g. *the geese's feathers*) (Payne, 2009, p. 326).

Zwicky (1987) accounted for Z haplology within the framework of realisation rules formulated in one of his previous works (Zwicky, 1985). He proposed that one realisation rule might be associated with more than one operation (e.g. the realisation of [Plural] in German is associated with operations such as umlaut or the suffixation of *-er*). If the condition on the realisation rule is not satisfied, the resulting form is unacceptable (e.g. **le homme* is ill-formed because the French masculine definite article *le* appears if the next word does not start with a vowel) (Zwicky, 1987, p. 142). On the other hand, one operation might be associated with two or more realisation

rules. For example, the three realisation rules of the regular plural, the regular third-person present inflection and the possessive are associated with one operation: the suffixation of /z/. The consequence of an unsatisfied condition on the operation of suffixation will not lead to unacceptability but to the failure of the operation itself. Zwicky (1987) suggested that the failure of attaching the possessive to words already suffixed with those morphemes is a result of an unsatisfied condition on the operation in (52):

- (51) In the context of [BAR: 0], [POSS] is realized by operation (52)
(52) Suffix /z/ in slot 2 unless there is a /z/ in slot 1.
(Zwicky, 1987, p. 143)

The affixation of the possessive in (52) is thus sensitive to the internal composition of the host word, that is, to the presence of the regular plural inflection, regular third-person present inflection and another possessive affix.

5.2.2 Exceptions to z haplology

Halpern (1995), on the other hand, observed that in some cases the suppression of /z/ fails to occur, such as *b* in the examples below:

- (53) a. a friend of his' car (is parked in the driveway)
b. a friend of his's car
- (54) a. a dog with fleas' fur (comes out when it scratches)
b. a dog with fleas's fur
- (55) a. a book with more than 300 pages' cover (is likely to fall off)
b. a book with more than 300 pages's cover

- (56) a. anyone who owns a cats' house (is likely to have fleas)
 b. anyone who owns a cats's house
 (adapted from Halpern, 1995, p. 124)

Note also that haplology is obligatory if the possessive attaches to the head plural, but optional on right-edge plurals (Bermúdez-Otero & Payne, 2011, p. 25; Halpern, 1995, p. 124). Another sort of exception Payne (2009, p. 325) noted is that haplology is optional for proper nouns ending in a plural segment (e.g. *Rameses* → /ræməsi:z/ or /ræməsi:zɪz/) and also for names of family groups ending with a plural segment but whose form in singular and plural is identical (e.g. *the Chambers/ the Chambers's*).

Anderson (2008) approached the problem of Z haplology with a strategy called 'recoding morphology as prosody' (Bermúdez-Otero & Payne, 2011, p. 27)⁵⁵. To avoid the claim that POSS-S is sensitive to the internal structure of its host, Anderson suggested that the regular plural is an adjoined material to the lexical structure rather than part of it:

- (57) Mousetraps

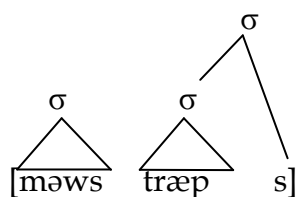

⁵⁵ Anderson's analysis here illustrates the dramatic change from considering inflections as phrase-level morphology (1992, 1982) to word-level morphology (2005) without offering an explanation. As indicated before, my argument is based on his work (1992).

According to Anderson (2008, p. 11), the justification for extrasyllabicity is based on phonotactic grounds⁵⁶; he stated:

...this account, widely accepted in the phonological literature, accommodates the observation that syllables ending in inflectional /z/ and /d/ commonly violate the regular phonotactics of the language, a fact that suggests that these elements are not actually part of the syllable at the lexical levels of the phonology.

In contrast, other alveolar fricatives at the end of words are not treated as extrasyllabic but rather as part of the structure itself:

(58) collapse

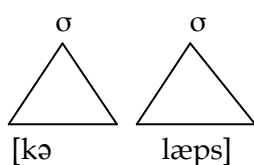

((57) & (58) are taken from Anderson, 2008, p. 11)

Here, Anderson claimed that (57) & (58) are two different structures and, accordingly, the realisation of the possessive will differ. For the structure with the adjoined plural, the possessive will fuse with the regular plural:

(59) My three mousetraps' only contents...

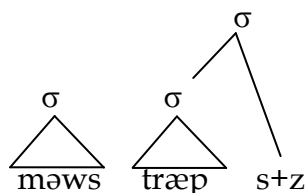

(adapted from Anderson, 2008, p. 11)

⁵⁶ Phonotactic rules refer to the phonological rules responsible for the acceptability of syllable structure, consonant clusters and vowel sequences.

For the structure without an adjoined material, the possessive will apply normally:

(60) The recent stock market collapse's only consequence. . .

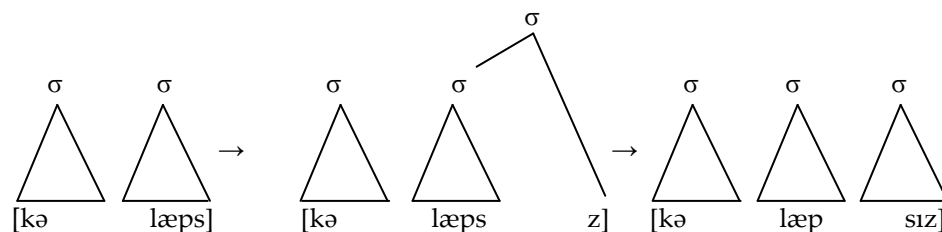

(taken from Anderson, 2008, p. 11)

However, in the case of proper nouns to which the possessive attaches normally or is reduced, Anderson suggested that this depends on the speakers' analysis of the structure. For example, /ræməsi:z/ is analysed as a structure with an adjoined regular plural, thus allowing for haplology, while /ræməsi:zɪz/ is analysed as a structure with the plural segment integrated into it.

Bermúdez-Otero & Payne (2011, p. 27) provided detailed criticism of Anderson's appeal to extrasyllabicity, arguing instead that the possessive marker is an inflectional suffix. The distinction in the behaviour of the possessive marker with words ending with either the regular plural or another alveolar fricative means that the possessive as a 'phrasal suffix' is able to look inside the internal structure of words, thereby violating two main principles: the strong lexicalist hypothesis (the atomicity of words; Di Sciullo & Williams, 1987, p. 49) and bracket erasure, which applies to the output of the morphological component deleting the internal brackets of

words, thereby preventing syntax from looking inside it (Kiparsky, 1982; Mohanan, 1986).

Recall that Anderson's extrasyllabic solution is based on phonotactic grounds. The conflicting fact, however, as argued in Bermúdez-Otero & Payne (2011), is that any word ending with coronal obstruents⁵⁷ violates the phonotactic rule regardless of whether they are realised as an inflectional affix or not and, in this case, the alveolar fricative in examples like *laps* and *lapse* should occupy an extrasyllabic position⁵⁸. What poses a crucial problem for Anderson's current theory is that, when these prosodic structures leave the word-level phonology, the possessive /z/ as a phrasal affix will not be able to capture the distinction between them by fusing with *laps* and attaching to *lapse*, further leading to ruling out grammatical instances like *lapse's* and *ounce's*.

The extrasyllabicity approach will also face another problem with proper or common nouns ending with fricatives but allowing for fusion with the possessive (e.g. *Socrates'*, *species'*, *series'*). Obviously, the fricatives cannot occupy an extrasyllabic appendix as it should be filled with a regular plural to allow for the fusion; as a result, such instances will be incorrectly ruled out at the post-lexical level.

⁵⁷ They include stops, fricatives and affricates.

⁵⁸ Researchers have even argued that coronal obstruents occupying an extrasyllable appendix are restricted to avoid the violation of the sonority sequencing generalization and rhyme maximality conditions (see Bermúdez-Otero & Payne, 2011, p. 29 for discussion).

The failure in the fusion between the regular plural and possessive /z/ in other dialects has also put Anderson's theory in more trouble. It is apparent in such dialects that the regular plural is in some way incorporated into a syllable coda before leaving the word-level phonology. This would be the only way in Anderson's treatment to prevent the possessive from fusing with it.

Finally, Bermúdez-Otero & Payne (2011, p. 27) described Anderson's appeal to extrasyllabicity as an 'ad hoc manoeuvre' to avoid a serious weakness in the theory. The effect of morphological structure on phonology is true, but the strategy of recoding morphological distinction as prosodic is unjustified due to the lack of independent evidence for resorting to the relevant prosodification and also because the approach conflicts with other facts in the language.

5.3 Possessive Compounds

A possessive compound is the third phenomenon that calls into question the separation of contextual inflections from the lexicon. In fact, three approaches to the status of possessive compounds have implications for the nature of the internal possessive morpheme.

First, Anderson (2013; P.C., 2009) claimed that this kind of construction does not affect the theory that the possessive is a phrasal affix simply because the construction is a phrase not a word.

We have seen in (§ 4.1) that Anderson (2008) analysed the possessive structure as a DP. The feature [POSS] was assigned to the DP specifier of DP by the rule in (25) above, repeated below:

(61) English Possessive (morphosyntax)

DP → [POSS]/ [DP [-]D X]

The DP *John's book* cannot contain another determiner (e.g. **the John's book*) since the function of the possessive morpheme itself is that of a determiner. Anderson (2013), on the other hand, claimed that constructions such as (*the women's magazine, the children's playground*) are noun phrases. They are called descriptive genitives and attributed to the descriptive function of the internal possessive morpheme⁵⁹. He proposed that a descriptive genitive is an NP not a DP. The NP specifier of NP is assigned [POSS] by the rule in (62) below:

(62) English Descriptive (morphosyntax)

NP → [POSS]/ [NP [-] N X]

(Anderson, 2013, p. 215)

Anderson (2013) employed two syntactic tests to prove that a descriptive genitive is a phrasal construction: coordination and modification. According to him, the first elements of descriptive genitives can be coordinated (e.g. *you'll find the men's and boy's clothing on the third floor*). Post-modification is also possible (e.g. *those sad little basset hound's dark eyes and floppy ears...*).

⁵⁹ The term 'descriptive genitives' will be used when dealing with arguments in favour of its syntactic analysis. For Taylor (1996), descriptive genitives bear features from compounds and prenominal possessives; for this reason, Taylor (1996) referred to such constructions as possessive compounds. I will follow him in using this term.

Second, a possessive compound is a fossilised structure (Huddleston & Pullum, 2002; Shimamura, 2000; Quirk et al., 1985), so it is unproblematic for the syntactic analysis of the possessive morpheme within split morphology hypothesis (Shimamura, 2000).

According to Huddleston & Pullum (2002), a descriptive genitive such as those in (63) below is a sub-type of attributive genitive⁶⁰:

⁶⁰ Another sub-type is measure genitives. According to Huddleston and Pullum (2002), a measure genitive can be either a noun phrase or nominal. As a noun phrase, the genitive occupies the position of a determiner, such as [*an hour's delay*] and [*one week's holiday*]. As a modifier, the genitive can be immediately preceded by a determiner, such as *this* [*hour's delay*] or a determiner + adjectival attribute, such as *a second* [*one hour's delay*]. The indefinite article *a* must be omitted if the genitive is in the modifier function (e.g. **this* [*an hour's delay*] vs. *this* [*hour's delay*]) (Huddleston & Pullum, 2002, p. 470).

The genitive construction is divided into five other categories which are noun phrases: (i) subject-determiner, (ii) subject of gerund participle, (iii) fused-subject determiner head, (iv) oblique genitive and (v) predicative genitive (Huddleston & Pullum, 2002). For a subject-determiner such as [*Kim's father*] *has arrived*, the noun phrase is in the subjective position, within which the possessive morpheme functions as a determiner; for example, it is interpreted as *the father of Kim* not **a father of Kim*. *No one objected to [Kim's joining the party]* is an example of the second type – namely, the subject of gerund-participle, in which the genitive specifies the subject of the gerund-participle clause. Informally, the genitive can be substituted with a clause like *no one objected to Kim joining the party* as the absence of the genitive does not affect the meaning of the clause. With regard to fused subject-determiner-head, alternatively referred to as independent genitive by Quirk et al. (1985, p. 329), such as *Max's attempt wasn't as good as [Kim's]*, the genitive noun is used independently; the noun following the genitive has been mentioned before and thus can be understood from the context. For the oblique genitive or double genitive, such as *she's a friend of Kim's*, the genitive construction is indirectly related to the noun *friend* by the preposition *of*. This is also referred to as post-genitive by Quirk et al. (1985, p. 330). What distinguishes the oblique genitive from the independent genitive is the feature of definiteness:

- | | |
|--------------------------|-------------------------------|
| (D) Independent genitive | a. Jim's friend |
| | b. Joseph Hayden's pupil |
| (E) Oblique genitive | a. a friend of Jim's |
| | b. a pupil of Joseph Hayden's |
- (Quirk et al., 1985, p. 331)

(63) a glorious [summer's day], a [sainsbury's catalogue], two [bachelor's degrees], a [woman's college], these very expensive [ladies' gloves]
(Huddleston & Pullum, 2002, p. 470)

Huddleston & Pullum (2002), Shimamura (2000) and Quirk et al. (1985) maintained that this type of genitive is fossilised in the sense that the possessor has an idiomatic relationship with the head noun. The structure is unproductive so we can find *a summer's day* and *a winter's day*, but it is questionable to say *?a spring's day* or *?an autumn's day* (Huddleston & Pullum, 2002, p. 470). Rosenbach (2006) here suggested that the lexicalised status of a possessive compound is widely accepted, so that could be the reason why it has received little attention. She demonstrated that although *a spring's day* or *an autumn's day* would not sound as acceptable as *a summer's day* and *a winter's day*, they still can be used, as illustrated by the following extracts:

(64) a. She was transported back to **a spring's day** long ago when life was sweet and young, full of hope and love. A day filled with tulips and daffodils and...

b. **An autumn's day** in Helsinki, hung out with my partner in the downtown area, browsing at the unique Scandinavian design shops.

(Rosenbach, 2006, p. 94)

For the predicative genitive, such as *all this is Kim's*, the genitive establishes a relationship between *Kim* and *all this*; thus, it can be interpreted as *all this belongs to Kim*. Structural overlap can occur between the independent genitive and predicative genitive. In the examples A: *I've got my towel but I can't find Kim's* and B: *This is Kim's*, the *Kim's* in both expressions can be classified as independent genitives; however, when the second expression is taken out of context, it is classified as predicative genitive (Huddleston & Pullum, 2002, p. 469).

Rosenbach (2006) further argued that possessive compounds (which she called 'descriptive genitives') in fact vary from fixed expressions as in (65) to transparent structures as in (66):

(65) fool's gold, baby's head, dog's cabbage, baby's breath, cat's-claw, cockscomb, devil's brushes, fool's parsley, dog's tongue, devil's horse, devil's cow, devil's fingers, a dog's breakfast, widow's walks

(66) women's underwear, engineer's chair, mechanic's overall, florist's clay, electrician's tape, baby's sleepers, bomber's jacket, painter's canvas, butcher's knife, men's suit, mother's milk, girls' school, women's magazine, driver's licence, smoker's cough, spider's web, squatter's rights, writer's block, pensioner's flat, lawyer's fees

((65) & (66) are taken from Rosenbach, 2006, p. 93)

Shimamura (2000) agreed with Anderson that the possessive morpheme is a phrase-level affix but disagreed with him that descriptive genitives are syntactic structures. According to him, descriptive genitives are lexicalised compounds. Shimamura (2000) suggested a synchronic reanalysis; *all* possessive compounds are generated in syntax but reanalysed as lexical structures via means of reanalysis rules such as those proposed in Abney (1987) (e.g. $N \rightarrow NP$). One advantage of his analysis, as he claimed, is that the nature of the possessive morpheme in both constructions is the same (i.e. a syntactic element) and thus does not pose any challenge to Anderson's split morphology hypothesis. Moreover, he claimed that his analysis was independently motivated by the phenomenon of phrasal compounds. A possessive compound is similar to the fixed phrases found inside compounds. In contrast to the evidence provided by Anderson (2013) mentioned earlier, Shimamura showed that a phrase within compounds does

not accept an item to be inserted within it because it is tightly fixed (e.g. *under-the-tree(s) picnic* → **under-the-tall-tree(s) picnic*). Similarly, for possessive compounds, the possessor in the non-head position does not accept pre- or post-modification because it is a reanalysed phrase **these [children's [rough and heavy shoes]]* (example from Taylor, 1996, p. 288).

The third, which this section advocates, holds that possessive compounds can be genuine complex words, like noun-noun compounds. The internal possessive morpheme in such structures is lexical and, thus, is assigned to stratum 2 in the base-driven stratificational model.

Possessive compounds reveal semantic and structural similarities with noun-noun compounds. Moreover, possessive compounds encounter the same problem, discussed previously in Chapter I (§ 1.1), associated with noun-noun compounds; both types might bear phrasal features, thereby making the task of establishing a sharp divide between phrasal constructions and compounds difficult. The fuzzy nature of possessive compounds calls into question the extreme positions adopted by Anderson (2013) and Shimamura (2000). Alternatively, it strengthens the argument that the structure can also be lexical. As a lexical structure, the internal possessive morpheme should not be analysed as a phrase-level inflection, which further supports the theory that all inflections, inherent and contextual, are word-level inflections.

First, I will discuss the semantic and structural similarities between possessive and noun-noun compounds (§ 5.3.1), followed by a discussion of

the fuzzy nature of possessive compounds (§ 5.3.2), arguing that Anderson (2013) oversimplified the issue by providing two diagnostic tests to prove that a possessive compound should be analysed as a phrasal construction, probably ignoring the important fact that such tests fail to draw a clear-cut distinction between lexical and syntactic N-N sequences (Bauer, 1998). In (§ 5.3.3), I suggest that Shimamura's evidence from phrasal compounds is also problematic.

5.3.1 Noun-noun and possessive compounds: structural and semantic comparison

With respect to syntactic constructions, English is a 'head-first language'; the head always precedes its complement (e.g. the head in *close the door* is the verb *close* which precedes its complement *the door*) (Radford, 2004, p. 15). For lexical constructions, there is general agreement on the notion of 'the syntax of words', which means that words can be analysed in terms of headedness and modifiers (e.g. Di Sciullo & Williams, 1987; Selkirk, 1982; Williams, 1981)^{61&62}. Heads in words follow their complements. Williams (1981) proposed the right-hand head rule (RHR); derived words and

⁶¹ This notion was questioned by Anderson (1992), Bauer (1990) and Zwicky (1985).

⁶² There are exceptional cases in which a compound lacks its property of headedness. For example, in a compound like *egghead*, the head noun does not seem overt since the supposedly right-most noun does not identify the semantics of the whole compound; the compound as a whole denotes a person who is intelligent. Similarly, *jack-in-the-box* and *good-for-nothing* are not a kind of modifier-modified construction like any normal compounds (e.g. *jack-in-the-box* does not refer to a kind of box or a kind of jack). Such multi-word consequences can be seen in two different perspectives: as a prepositional phrase (jack is modified by *in the box* or, more appropriately, as a 'lexicalised phrase' because it is not decomposable and known 'holistically' by the speakers (Plag, 2003, p. 136).

compounds have their heads at the right-most⁶³. Through percolation, the head identifies (i) the grammatical category of the whole compound (e.g. *fry* in *deep-fry* is a verb, so the whole compound is a verb), (ii) the number feature (e.g. the compound is marked with the feature [+PLURAL] if the head is a plural as in *tooth marks*), and following from this the plural inflection inside compounds cannot affect the syntactic property of the whole compounds, and (iii) the gender (e.g. if the head has a feminine gender as in *head-waitress*, the compound will inherit this property) (Plag, 2003, p. 135). Semantically, the head is a ‘hyperonym’ of the whole compound (Hoeksema, 1992, p. 120)⁶⁴:

Semantic: The head of A is a hyperonym of A, i.e. when A denotes a set X, the head of A denotes a superset of X. Example: *apple pie* - *pie*: *pie* is the head because it is a hyperonym of *apple pie*: every apple pie is a pie. *Apple* is not a head, since it's not the case that every apple pie is an apple.

Note that an N-N compound displays diversity in the semantic relationships between its constituents; for example, in the case of compounds such as *housekeeping*, the indirect meaning of skill, art or practice cannot be extracted from the mere combination of its elements (Marchand, 1969, p. 16), while the semantic relationship between the constituents of a phrase is

⁶³ We have seen in (§ 1.3) that suffixes are category-changing (e.g. [[happy_A] -ness_N]_N). Williams (1981) argued that this is a natural consequence of RHR; the suffix *-ness* is the head of the word.

⁶⁴ See Hoeksema (1992) who disagreed on the definition of ‘head’ in terms of semantics. He agreed on the technical side of the definition (i.e. the part that determines the category of the entire construction).

transparent (e.g. the semantics of the noun phrase *beautiful picture* is very clear).

The degree of transparency in the relationship between the constituents of compounds varies; it ranges between an ambiguous type like *bahuvrihi compounds* whose semantics cannot be predicted from its constituents (e.g. *silverfish, hatchback, redneck*) and an almost transparent type like synthetic compounds (e.g. *taxi driver*).

Similarly, the head of the possessive compound is on the rightmost of the construction, such as *magazine* in *woman's magazine*. In contrast, the head of the prenominal possessive appears on the left, which constitutes an NP and acts – along with the possessive morpheme – as a determiner of the possessum; for this type of construction, [NP [DET NP POSS] [N']] is the schematic structure suggested by Taylor (1996, p. 288)⁶⁵.

When using an initial determiner, the possessive compound requires number agreement between that initial determiner and the head, as illustrated in (67):

- (67) a. these [woman's magazines]
b. *this [woman's magazines]

In contrast, when an initial determiner is used in a prenominal possessive construction, it must agree in number with the possessor, as in (68):

⁶⁵ Unlike Anderson (1988, 1992), Taylor (1996) and Rosenbach (2006) adopted the analysis of NP rather than DP when dealing with the determiner genitive (or prenominal possessive, as referred to in Taylor, 1996).

- (68) a. [*these woman]'s magazines
b. [this woman]'s magazines
(67) & (68) are adapted from Taylor, 1996, p. 290

However, a structural ambiguity remains if all items agree in number, such as whether a structure like *the woman's magazine* can be analysed into a descriptive genitive (i.e. *the [woman's magazine]*) or a prenominal possessive (i.e. *[the woman's] magazine*).

Taylor (1996) observed that the relationship between the possessor and the possessum in a prenominal possessive is subject to semantic and pragmatic considerations. One example Taylor (1996) mentioned is *[the woman]'s magazine*. The default reading is *the magazine possessed by the woman*; however, this construction is also open to different readings, such as '*the magazine that the woman is reading*', '*the magazine that she edits*', and '*the magazine that she writes for*' (p. 288). The difference between lexical and pragmatic interpretation is illustrated in (69) & (70):

(69) **Lexical interpretations**

- a. The girl's teacher
'the person who is the teacher of the girl'
- b. The girl's nose
'the nose which is a part of the girl'
- c. The girl's car
'the car which the girl has at her disposal'

(70) **Pragmatic interpretations**

- a. The girl's teacher
'the teacher whom the girl has married, the teacher she is dreaming of,..'

b. The girl's nose
'the nose the girl has drawn, the nose the girl has operated on, ...'

c. The girl's car
'the car which the girl has ordered, the car she has smashed to pieces, ...'

(Vikner & Jensen, 2002, p. 195)

On the other hand, the possessive construction [*woman's magazine*] refers to a type of entity; the first constituent functions as a type of 'restrictive modifier'. Similar to pronominal possessives, the interpretation of the possessive is open to semantic-pragmatic consideration.

5.3.2 The fuzziness of possessive compounds

In the following sections, I will review a number of criteria employed to distinguish possessive compounds from pronominal possessives, none of which are without exceptions.

5.3.2.1 Phonological criterion: stress

Taylor (1996) observed that possessive compounds tend to have the primary stress on the first element, like many noun-noun compounds, such as those in (71), while pronominal possessives have the primary stress on the final element of the construction, as in (72):

- (71) a. [wóman's magazines]
b. [dríver's licence] ((a) & (b) are taken from Taylor, 1996, p. 291)
- a. [mén's room]
d. [Bróca's aphasia] ((c) & (d) are taken from Spencer, 2003, p. 331)

- (72) a. [the woman]'s magazine
b. [the truck driver]'s licence.
(Taylor, 1996, p. 291)

However, possessive compounds in (73) are end-stressed like phrases:

- (73) a. Foucault's Péndulum
b. Hodgkin's lymphóma

The nouns inside compounds in (73) are the discoverers after whom the diseases were named, but with their head nouns they denote types of diseases. A very recent possessive construction is *Higgs' particle*, a particle named after its discoverer *Peter Higgs*, but it has now a generic interpretation like other possessive compounds, that is, it refers to the type of particle rather than to the individual who discovered it. The compound has entered the dictionary (Collins On-line Dictionary- 2013) with an end-stress /hɪgz 'pa: tɪkəl/. Similar to the discussion put forward by Giegerich (2005) for variable stress patterns in noun-noun compounds, there are two possibilities: (i) such possessive compounds were originally prenominal possessives that entered the lexicon but kept their phrasal stress or (ii) they were coined in the lexicon in analogy to existing end-stressed possessive compounds.

However, unlike the constructions in (73), *Bróca's aphasia* is also a type of disease, named after its discoverer Pierre Paul Broca, but it is fore-stressed. Similar to end-stressed compounds, it is not clear whether *Broca's aphasia* was coined as a compound or was originally a phrase and underwent lexicalisation during which it lost its end-stress. In general, this confusion

further supports the claim that rightward stress cannot be relied upon to assert that a possessive compound is a phrase.

5.3.2.2 Syntactic criteria

The lexical integrity hypothesis holds that the internal structure of the word is immune to any syntactic operation due to the independence of morphology from syntax (Chomsky, 1970) and, as a consequence, compounds can be distinguished from phrases by employing syntactic tests; an N-N sequence is a word if such tests do not apply (Bauer, 1998).

However, we will see in this section that a number of syntactic tests failed to draw a clear-cut distinction between a lexical and syntactic concatenation, with an important conclusion that possessive compounds should not be classified as syntactic on the basis of such tests.

(a) *Definiteness and referentiality*⁶⁶: as mentioned previously in (§ 5.3.1.1), the possessor in a prenominal possessive has a determiner function so it turns the whole NP definite. In other words, the [NP's N] denotes a specific individual or thing, and the use of another determinative will lead to ungrammaticality (e.g. **the John's book*, **this the man's book*) (Rosenbach, 2006, p. 80).

On the other hand, the first element in the possessive compound does not convey either a specific or non-specific reading because it is type-

⁶⁶ Referentiality refers to the speaker's use of certain expressions to allude to an existing referent. A non-referential expression can be used when generic semantics are intended (Rosenbach, 2002).

restricted. Compare, for example between *my children's clothes* vs. *children's clothes*; the left constituent in the former is token-restricted, while it is type-restricted in the latter.

There is a correlation here between semantics and referentiality. Taylor (1996) regarded referentiality as an important criterion of distinctiveness between prenominal possessive and possessive compounds. The left constituent of a prenominal possessive has a specific reading so it can serve as a point of reference, while this is unavailable for a possessive compound. For example:

- (74) a. I found [that woman_i]'s magazines, but as far as I know, she_i has not read them.
b. A: I found [that woman_i]'s magazines
B: Whose_i magazines did you say you had found?
- (75) a. *I found those [woman_i's magazines], but as far as I know, she_i has not read them.
b. A: I found those [woman_i's magazines]
B: *Whose_i magazines did you say you had found?
- (Taylor, 1996, p. 291)

The possessive construction in (74) is a prenominal possessive; the possessor *woman's* is an antecedent identified by the anaphoric elements *she* (74a) and *whose* (74b). In contrast, the possessive construction in (75) is a compound, whose internal noun cannot establish a co-referential relationship with anaphors.

However, according to Rosenbach (2002, 2006), the correlation between definiteness and referentiality is not always the case; indefinite

expressions can be equally employed to convey a specific or non-specific reading:

- (76) a. I bought a new book
b. I'd like to have a book for my birthday, but I don't know yet which one

(Rosenbach, 2002, p. 51)

The context in (76a) forces a referential interpretation despite use of the indefinite article. The noun *book* is specific in the mind of the speaker, who assesses its unfamiliarity for the hearer. In contrast, the context in (76b) forces a non-specific interpretation since *book* has not yet been identified in the speaker's mind. This also applies to pronominal possessives, thereby creating a degree of fuzziness between lexical and syntactic constructions:

- (77) a. I spent an hour reading a student's essays.
b. Reading a student's essays is something I hate doing.
c. Reading students' essays is something I hate doing.

(Taylor, 1996, p. 297)

The first two constructions are pronominal possessives, obviously confirmed by the agreement of the indefinite article with the possessor. Semantically, (77a) refers to a specific individual in the speaker's mind, while (77b) refers to a non-specific individual. Meanwhile, the construction in (77c) might have a lexical status due to its generic interpretation of the non-head; *students* can be interpreted as a type rather than an individual. If post-modification is considered a reliable diagnostic test, *students' essays* is a phrase on the grounds that the head can be independently modified:

- (78) I hate reading students' [handwritten essays]

Interestingly, it is a compound since the whole construction can be modified (Taylor, 1996), demonstrating that there is a kind of overlap between syntactic and lexical analyses of the possessive construction:

(79) I hate reading handwritten [students' essays]
(78) & (79) are taken from Taylor, 1996, p. 298)

This sort of blurred division is further illustrated by an example like *a man's skull* (Taylor, 1996, p. 298). This example encounters a similar analytical problem: it aligns with the analysis of a possessive compound in terms of semantics. First, it is possible to say that *a man's skull* in an example like *the archaeologist discovered fragments of a man's skull* has a generic reference whose non-head denotes a type rather than individual (e.g. *fragments of a type of skull that has the characteristics of male human skull*).

On the other hand, *a man's skull* aligns with the analysis of a prenominal possessive: it is also possible that the construction refers to a non-specific individual (the construction refers to the skull of a non-specific individual who belongs to the category 'man'). Moreover, the possessor may allow for a co-referential pronoun (e.g. *the archaeologists found a forty-thousand-year-old man's skull. It is not known how old he_i was when he_i died*).

However, the syntactic analysis of *a man's skull* is weakened by the issue of modification. An initial adjectival modifier can modify the first element, giving two possible constructions:

(80)	a phrase		a compound
	[[a forty-year-old man]'s [skull]]	OR	a [[forty-year-old man]'s [skull]]

Moreover, *man's skull* does not accept an internal modification; it is compatible with the status of a compound (e.g. **a man's forty-thousand-year-old skull*).

(b) *Coordination*: Anderson (2013) maintained that descriptive genitives are syntactic structures and should not be treated as compounds; the difference between descriptive genitives and pronominal possessives is that the possessive attaches to NP in the former and to DP in the latter. Thus, the appearance of the possessive marker inside such constructions does not pose any problem to Anderson's argument. His claim depends on the criterion of the ability of coordination between the first and second element of two descriptive genitives:

(81) You'll find the **men's and boy's clothing** on the third floor
(Anderson, 2013, p. 215)

(82) a . . . they've found **kids' and women's clothing** in a hidey-hole in Fox's bus.
b. **Men's and boys' overalls** and corduroy shirts speak of a household without a woman.
c. We try not to involve our clients in expensive **consultant's or lawyer's fees**.
(Rosenbach, 2006, p. 84)

As discussed earlier (§ 5.3.2.3.1.3), Payne & Huddleston (2002) claimed that the coordination between the non-heads or heads of a compound should be prohibited (e.g. **buttercup and saucer* or **bread and buttercup*). On the other hand, Bauer (1998), Dalrymple & Nikolaeva (2006) and Bell (2012) argued that coordination is possible if it represents a case of natural coordination, i.e. if the items are semantically related. Indeed, the items coordinated in the

examples above are permitted because of their semantic closeness, hence questioning the evidence upon which Anderson (2013) relied in his syntactic analysis of 'descriptive genitives'.

(c) *Modification*: the standard criterion is that the elements of a compound should not be independently modified. As Lieber (1992a, 1992b) suggested, a more reliable test of the phrasal status of an N-N sequence is the possibility of modifying the head. If an adjective is placed between the possessor and the possessum (e.g. *the woman's torn magazine*), the compound reading is excluded (Taylor, 1996, p. 290). Meanwhile, in a prenominal possessive, the possessor can be pre-modified:

- (83) a. [the old man]_{NP}'s book
(Rosenbach, 2006, p. 80)

Post-modification in prenominal possessives is also possible:

- (84) a. [The man]'s [dark blue shirt]
b. [The drunken driver]'s [recently issued licence]
(Taylor, 1996, p. 288)

Similar to the previous diagnostic tests, modification does not succeed in making the wanted distinction. As in ordinary noun-noun compounds, we can also find an initial adjective that modifies either the entire possessive compound (85) or the first element, forming a phrase inside compounds, as in (86):

- (85) an expensive [boys' school]
(86) a [[young boys]' school]
(Taylor, 1996, p. 289)

Pre-modification is subject to restrictions—namely, they should be simple:

- (87) a. *an [exceptionally gifted childrens]'s school
b. *a [children who are gifted]'s school
- a. *a [very old people]'s home
b. *a [people who are old]'s home
(Taylor, 1996, p. 288)

The semantics of the initial adjective would also force a specific reading; for example, it is only appropriate for the adjective *torn* in *torn woman's magazine* to modify the whole compound (i.e., *torn [woman's magazine]*).

Rosenbach (2006, p. 85), moreover, provided the following counterexamples to the criterion of inseparability:

- (88) a. He folded his hands over his old man's soft belly and nodded benignly at Martha...
b. Their confrontation that morning in the breakfast room had taken care of that, with the real women smoked out from beneath the guise of dutiful hostess and professor's perfect wife
c. And reached for his pipe and a copy of Punch which he'd long ago decided were appropriate for a gentleman's Sunday afternoon reading

The examples in (88) would be evidence that inseparability is not a reliable test to draw the wanted clear division, but Rosenbach (2006) admitted that such instances are rare and found in literary contexts rather than in the daily use of language. She also provided data from the Internet to demonstrate that modifiers intervene between the two elements of the expressions so that — as she argued — the expressions are believed to have compoundhood status on a semantic basis; they refer to a type of entity

rather than a specific individual or thing and the second element appears to be the head noun:

- (89) **men's suit**
recognisable as a genuine men's formal suit
- (90) **women's magazine**
standard mix for a typical women's glossy magazine
- (91) **driver's licence**
A valid driver's UK licence is a must.
- (92) **smoker's cough**
This is referred to as 'smoker's morning cough'. Prolonged exposure to smoke permanently affects the cilia's ability to clean out the lungs, exacerbating the...
- (93) **fool's gold**
Oil price spike is fool's (black) gold
- (94) **fool's errand**
...Quixote not as mad, but as merely foolish – arguing vigorously that the pursuit of justice which Quixote symbolizes may be essentially a fool's blessed errand...
- (95) **mechanic's overall**
Wearing uniform was taking sides. I had a grey civil defence chemical weapons suit and found a discarded mechanic's khaki overall.
(Rosenbach, 2006, pp. 86-87)

Again, Rosenbach acknowledged that such examples constitute the minority when compared with ordinary compounds that do not accept a separate modification of the head (550 hits for *fool's *errand*: 181,000 hits for *fool's errand*; Google 15/09/2005). According to Rosenbach, since the separation of the two constituents is more likely to occur if the construction is a syntactic construction, one possible explanation is that compounds accepting post-modification are lexicalised phrases. It is also important to

mention that Lieber's criterion of inseparability should be taken as a reliable test if it excludes the compound reading and, as illustrated in the examples in (89-95), the compound reading is still understood: "the elements of a compound in English may not be separated by an intervening modifier of any sort, at least not without eliminating the compound's meaning" (1992a, p. 84).

A more confusing structure, namely 'a pair-of construction', illustrates how the distinction between prenominal possessives and possessive compounds can be really blurred. This structure differs from a partitive structure. 'A pair-of construction' should be followed by a noun, and it is obligatory if that noun is a plurale tantum (e.g. *a pair of glasses*, *a pair of pliers*). Partitive constructions, on the other hand, are followed by NPs, and they denote a small number or amount from a larger set. Following from this, the noun in a pair-construction can be substituted with another lexical structure such as a possessive compound (e.g. *a pair of men's pants*). The possessive compound here can be adjectively modified: *a pair of [dark blue men's pants]*, which is consistent with the standard criterion of compounds. However, there is also the possibility of finding an adjective intruding into its constituents (e.g. *a pair of [men's dark blue pants]*, but without excluding the meaning of the compound.

To sum up discussions of (§ 5.3.1 and § 5.3.2), possessive compounds revealed deep similarities with noun-noun compounds on semantic and structural grounds. Moreover, the diagnostic tests discussed throughout the

previous sections failed to draw a sharp divide between compounds and phrases, which consequently refutes Anderson's (2013) claim that possessive compounds are phrases as well as Shimamura's (2000) claim that possessive compounds are fixed phrases.

In the following two sections, I will discuss the phenomenon of phrasal compounds used by Shimamura as supporting evidence for the fixedness of possessive compounds. It will be argued in (§ 5.3.3) that not all phrasal compounds are frozen; they can also be transparent, which is evident in the case of plural noun phrases (e.g. *historic buildings inspector*). In fact, the 'onomastic possessive' (e.g. *Halley's comet*) would be the type of possessive compound that is coherent with Shimamura's proposal of phrasal reanalysis (see § 5.3.4).

5.3.3 Phrasal compounds

Phrasal compounds are defined as "constructions in which a phrase appears to occur within something which otherwise looks rather like a compound or derived word" (Lieber, 1992b, p. 11):

- (96)
- | | |
|--------------------------------|-------------------------------|
| a. the Charles and Di syndrome | b. a pipe and slipper husband |
| c. a floor of a birdcage taste | d. over the fence gossip |
| e. in a row nests | f. off the rack dress |
| g. a slept all day look | h. pleasant to read book |
| i. an ate too much headache | j. a connect the dots puzzle |

Lieber examined whether the construction in (96) has the status of compoundhood using the diagnostic tests of stress, inseparability and the non-occurrence of these phrases as full NPs (or maximal phrases). Although

stress cannot be relied upon for the reasons discussed in Chapters I and II (§§ 1.1.2 & 5.3.2.1, respectively), the constructions in (96) conform to the predicted compound stress pattern; the rightmost element of the phrase is heavily stressed (e.g. *a floor of a **birdcage** taste*).

Moreover, phrases in the non-head position cannot be maximal projections (e.g. [_N [_{PP} over the fence] [_N gossip]]) (Lieber, 1992b, p. 56), which is a characteristic of a compound, e.g. for a proper noun *the Bronx* when involved in compounding, the definite article must be eliminated (e.g. **the Bronx hater*) (Sproat, 1985, p. 196). For inseparability, phrases in the non-head position cannot be separated (e.g. **a floor of a birdcage **salty** taste*).

For productivity, it is an important characteristic because it will rule out the claim that only idioms or lexicalised phrases are permitted to be elements of compounds. However, Lieber (1992b) did not provide strong evidence from English compounds in this respect. She reported Baayen's observation, based on a Dutch corpus of 40 million words, that Dutch phrases inside compounds usually appear in *hapaxes* (e.g. the following phrasal compounds occurred only once, *bijna-eigenlijk-ook-meester* 'almost-in-fact-also-master', *in-het-wilde-wegmanier* 'in-the-wild-way-manner' (Lieber, 1992b, p. 13)⁶⁷. Lieber (1992b) concluded that phrasal compounds provide

⁶⁷ Baayen (1992) proposed a measure of productivity by investigating a large corpus to determine whether a productive process creates 'hapax legomena'. Booij (2002, p. 12) described this measure, "...word types instantiating the relevant morphological process for which there is only one token in a given corpus. The number of hapax legomena in a corpus for an unproductive process will be very low, since these are mostly word types of high frequency, whereas a productive process will create a much higher number of words with frequency".

further evidence that there is a convergent boundary between syntax and morphology; in other words, the phrases are formed in syntax and their eligibility to feed into compounding is due to the nature of interaction between lexicon and syntax.

Carstairs-McCarthy (2005, 2002) and Wiese (1996), on the other hand, argued that the theory of the sharp divide between syntax is not necessarily weakened by phrases inside compounds simply because they are stored in the lexicon. Some of these constructions seem to have the problem of 'bracketing paradoxes', which means that they appear to be associated with the reading of an ordinary compound modified as a whole by an adjective or of a phrasal compound. I will review some basics of the notion of 'bracketing paradox',⁶⁸ and its implication for phrasal compounds (Carstairs-McCarthy, 2005, 2002; Spencer, 1988).

Bracketing paradoxes refer to conflicts between the grammatical bracketing of a complex word and its meaning. An example taken from Spencer (1988, p. 667) is *nuclear physicist*; this term refers to 'an expert in the field of nuclear physics'; however, if we assume that its grammatical bracketing is *[[nuclear] [physicist]]*, it will conflict with the normal meaning, yielding instead **physicist is nuclear*. On the other side of the coin, if the meaning is the indicator of how a structure will look, then 'an expert in the field of nuclear physics' will lead to the structure *[[nuclear physic-] -ist]*, which,

⁶⁸ For the notion of 'bracketing paradoxes', see Spencer (1988) for an extensive discussion.

however, allows the suffix to attach to the phrase rather than to the lexical item. Likewise, the meaning of *rural historian* ‘expert in the history of countryside’ would be associated with a similar structure $[[rural\ histori-] -an]$ (Carstairs-McCarthy, 2005, p. 36). Spencer (1988), however, argued that the structure in which the suffix attaches to the phrase cannot be upheld due to the existence of constructions that have the meaning of ‘expert in the field’, but are devoid of a suffix (e.g. *chemical engineer*, *plastic surgeon*), and the structure then available is $[chemical_A [engineer]_N]_{N'}$, $[[plastic_A [surgeon]_N]_{N'}$, which should be generalised to include $[[nuclear_A [physic-ist]_N]_{N'}$. He further proposed that such structures have a semantic slot to be filled with the appropriate interpretation.

Carstairs-McCarthy (2005, p. 36) suggested that the problem of bracketing paradoxes is apparent because there is a degree of institutionalisation with these structures; for example, if *nuclear* is substituted with *recent*, the result is the ill-formed phrase $*[[recent_A [physic-ist]_N]_{N'}$. Similarly, $[rural_A [historian]_N]_{N'}$ might be associated with two interpretations: (i) ‘historian living in the country’ or (ii) ‘expert in the history of the countryside’. *Rural* for the second interpretation is institutionalised, which means that if it is substituted with *suburban*, the interpretation of ‘expert in X’ will not be conveyed (e.g. $?[suburban_A [historian]_N]_{N'}$ → ‘expert in the history of suburbia’).

As far as phrasal compounds are concerned, Carstairs-McCarthy (2005, 2002) had a similar explanation. A construction like *American history teacher*

also might have bracketing paradoxes:

- (97) a. an ordinary compound, i.e. an adjective modifies N-N word:
American [history teacher]
b. a phrase inside a compound, i.e. an adjective modifies the non-head
independently: [*American history*] teacher

If the second structure is taken into account, i.e. a genuine phrase inside a compound, the argument for the lexicon-syntax overlap discussed in the previous chapter (§ 1.1) is borne out. Taking Spencer's solution into consideration, a phrase inside compounds can be avoided by adopting the first bracketing; one meaning mirrors the structure, while the other meaning (i.e. the reading of the phrasal compound) will fill the semantic slot associated with it, which means that there is some sort of lexicalisation with these phrases. To maintain this solution, Carstairs-McCarthy (2005, p. 37) further argued that phrases do not occur within compounds freely, but only in phrases that are lexicalised (idioms) or institutionalised (clichés)⁶⁹. If *American* in the example above is substituted with another adjective like *dull* or *glorious*, the meaning of the phrasal compound will be odd. With such adjectives, a structure of the kind [N [N N]] is the only possibility. Compare *a* with *b* versions in the following examples:

⁶⁹ We should make a distinction here between lexicalisation and institutionalisation. The term lexicalisation refers to the changes that occur to words over history. It can be related to phonology (e.g. vowel reduction of *man* [mæn] into /mən/ in complex words like *policeman*, or stress shift in *admire* /əd 'maɪə/ vs. *admirable* /'æd.mɪrəbl/), orthographic (e.g. *forget-me-not* vs. **forget me not* – *don't forget me*) or semantics (e.g. *watchmaker* refers now to 'the person who repairs watches') (Hohenhaus, 2005, pp. 353–354). On the other hand, institutionalised items refer to words or phrases used as technical jargon (e.g. *defective component* can be found in a manufacturer's manual (Carstairs-McCarthy, 2002, p. 37)) (For a comprehensive discussion on lexicalisation vs. institutionalisation, see Lipka, 2005).

- (98) glorious history teacher a. *[glorious history] teacher_N
 b. [glorious [history teacher]]
- (99) dull history teacher a. ?[dull history] teacher
 b. [dull [history teacher]]
- (Carstairs-McCarthy, 2005, p. 37)

According to Carstairs-McCarthy, *American history* is a special term (a cliché) in this construction and cannot be substituted with any adjective such as *dull* or *glorious*. Of course, *dull* or *glorious history* could be uttered, but it sounds odd to say *a teacher of dull history* or *a teacher of glorious history*.

Similarly, in the *defective component problem* when analysed into *[defective [component problem]]*, the meaning that reflects this structure has nothing to do with lexical storage; *defective* can be substituted with *expensive* or *Norwegian* without affecting the well-formedness of the whole structure:

- (100) a. [expensive [component problem]]
 b. [Norwegian [component problem]]
- (Carstairs-McCarthy, 2005, p. 39)

On the other hand, the semantic slot associated with the same structure can be filled with a meaning corresponding to the cliché 'defective component'. To prove that in this case it is a stored phrase, the adjective *defective* cannot be substituted with *expensive* or *Norwegian*: *[expensive component] problem*, **[Norwegian component] problem*.

However, an example such as *[open [door policy]]* differs from the previous examples in that its actual meaning does not match its structure 'open policy about doors'. The only meaning, which is disassociated from the structure, is 'policy of maintaining an open door'. Carstairs-McCarthy (2005,

p. 81) also suggested that [*open door*] found inside *policy* is a cliché; if it is substituted with [*wooden door*], the structure ?[*wooden door*] *policy* ‘wooden policy about doors’ is questionable. Similar examples are listed in (101):

- (101) a. fresh air fanatic
b. ?cool air fanatic

- a. sexually transmitted disease clinic
b. ?easily transmitted disease clinic

(Carstairs-McCarthy, 2002, pp. 81-82)

In addition, Wiese (1996, p. 188) maintained that compound-internal phrases are quotations embedded in compounds:

In quotation, material from one domain (the quoted expression) is used and embedded in some other domain (the matrix expression)... In its most restricted sense, quotation means the repetition of an utterance made by some other speaker, but it requires only a minimal abstraction and extension to allow a wider domain of application, such as quoting a (spoken or written) word of a language, or a particular style of speaking.

Evidence for the status of a quotation comes from the existence of bilingual phrasal compounds, for example, *die No-future-Jugendlichen* ‘the no-future youngsters’ *die just-in-time-Garantie* ‘the just-in-time guarantee’ and, accordingly, quoted phrases within compounds cannot then falsify the strong lexicalist hypothesis (Wiese, 1996, p. 186).

Although Carstairs-McCarthy’s argument that phrases do not appear freely unless they are lexicalised or institutionalised is well motivated, Giegerich (2005) raised a sceptical question about the issue of lexicalisation. He pointed out that it is difficult to tell when the process begins or ends. A phrase does not lose its syntactic features suddenly at some point in time.

The nature of phrases during the gradual process of transition from a full NP to a full N (a frozen phrase) will then be fuzzy (i.e. they are ‘N(P)s’), motivating the assumption that genuine phrases and fossilised phrases take the position of the ends of a continuum, Ns—NPs, but there are also phrases that should be positioned in between; they are neither purely syntactic nor purely lexical, Ns—N(P)s—NPs (Giegerich, 2005, p. 50). Carstairs-McCarthy’s description of constructions such as *American history teacher* and *fresh air fanatic* as ‘apparent paradoxes’ implies that the nature of internal phrases is ambiguous between lexicalisation and syntacticity cannot be equalled with a frozen phrase such as *kick the bucket*. In this case, the internal phrase *American history* should be positioned in between; it would more lexical for some speakers and more syntactic for others.

Interestingly, there is also a group of phrases — plural noun phrases — that can appear productively inside compounds and, accordingly, further demonstrate the lexicon-syntax overlap. With a novel construction like *red rat eater* coined by Alegre and Gordon (1996), the paradox manifests itself; it could refer to *a rat eater whose colour is red*, which is probably preferable, but it also does not rule out the interpretation of *an eater of red rats*. The two constructions are illustrated below:

- (102) a. [Red [rat eater]] (NP - a compound modified by an adjective)
 b. [[Red rat] eater] (N - a phrasal compound)

Obviously [red rat] is a normal phrase, not a cliché; if Carstairs-McCarthy's test is used (e.g. If *red* is substituted with another adjective like *big*), the paradox still remains:

- (103) a. [big [rat eater]]
 b. [[big rat] eater]

Interestingly, if *rat* is pluralised, the paradox vanishes, but the result in this case is not compatible with the structure endorsed by Carstairs-McCarthy (2002, 2005), i.e. [Adj [N N]_N]_{NP}. It demonstrates that the structure of the type [[Adj N]_{NP} N]_N does exist:

- (104) red rat eater a. [red [rat eater]]
 b. [[red rat] eater]

- (105) red rats eater a. [[red rats] eater]
 b. *[red [rats eater]]

Indeed, the bracket *[N-s-N] in (105b) will not be freely allowed to generate in grammar. Similarly, *new books shelf* and *historic buildings inspector* can only be analysed into [[*historic buildings*] *inspector*] and [[*new books*] *shelf*].

The claim that phrases appear inside compounds has been demonstrated by experiments conducted on adults (Senghas et al., 1991) and on children (Alegre & Gordon, 1996).

In Senghas et al.'s (1991) study, the participants were required to judge compounds such as *modern city guide* and *modern cities guide* in contexts that trigger either the meaning *a city guide that is modern* [*modern* [*city guide*]] or *a guide of modern cities* [[*modern cities*] *guide*]. The inflected internal nouns promoted the recursive interpretation, i.e. *a guide of modern cities*. However,

when the internal nouns are in the singular form, the participants preferred the non-recursive interpretation, i.e. *city guide that is modern*. Similar results were obtained by Alegre and Gordon (1996). Children as young as three years old were sensitive to the differences between instances such as *red rats eater* by pointing to a picture where the rats were red, i.e. [[red rats] eater] and *red rat eater* by pointing at a picture where the eater of rats is [red [rat eater]]⁷⁰.

5.3.4 Onomastic possessives

As previously mentioned, Shimamura claimed that phrases found inside compounds are ‘frozen’ and this provides independent evidence that the internal possessor also receives the same analysis. The outcome of the previous discussion has shown that not all internal phrases are completely lexicalised; they range from fossilised expressions that do not accept any kind of change to completely productive phrases. Similarly, not all possessive compounds are tightly fixed expressions; they are fuzzy just like

⁷⁰ Syntactic recursion was discussed within level ordering. *Rats* is as good as *red rats*, but the difference becomes obvious when they are used as non-heads in compounds: **Rats eater* obeys the level-ordered constraint while *red rats eater* is generated by the mechanism of *syntactic recursion* incorporated into Kiparsky’s level-ordering model. It refers to the idea that some constructions formed at the syntax level like *red rats* are allowed to go through the ordered levels again and, of course, in this way interact with the rule of compounding. Alegre and Gordon (1996) argued that children innately recognise this, which means that their morphology is constrained by the mechanism of syntactic recursion. The difference between the two constructions is that (a) is generated in syntax by means of a level-ordering constraint whereas (b) is generated in syntax and then submitted to the compounding rule recursively. Although this mechanism violates the ordering of the levels, it ascertains a very important notion – the interaction between morphology and syntax – as the original model imposes a strict divide between them.

noun-noun compounds. However, an onomastic possessive in (106) might be a good example of Shimamura's reanalysed phrases:

(106) Halley's comet, Ockham's razor, Hobson's choice, St Valentine's day, Parkinson's disease, St Vitus' dance, Zeno's paradox

The first element is a specified individual just like *John's book*; accordingly, the construction is definite in that it might not require a determiner (e.g. **the John's book* and **the Halley's comet*). Based on this, an onomastic possessive would have the same structure of a prenominal possessive (i.e. [NP[NP POSS] [N]]) → *we watched in vain for [NPHalley's comet]*.

These names have been conventionalised; they no longer refer to individuals but to a kind of entity. A piece of evidence for conventionalisation comes from the onomastic possessive *Molotov's cocktail*, which refers to the petrol bomb named after a former foreign minister of the Soviet Union [[*Molotov's*] [*cocktail*]]_{NP}. In a text dating back to 1940, *Molotov's cocktail* was used as a possessive compound, which means that the topicality of the non-head is substantially lowered; it denotes a kind of entity [*Molotov's cocktail*]_N:

...we regaled with stories about the damage which had been done by 'Molotov's bombs'. Everyone apparently speaks of them in this fashion, and when the aeroplanes are heard to be dropping their deadly cargoes, the people say 'Molotov is barking again'. Similarly, when the soldiers attack the Russian tanks, they call their rudely-made hand grenades 'Molotov's cocktails'.

(Citrine, as cited in Taylor, 1996, p. 311)

As the process of lexicalisation proceeded, the whole construction lost its possessive morpheme and turned into a noun-noun compound

[*Molotov cocktail*]_N. Today, it has a default interpretation as it refers to 'homemade bombs'.

As a result of lexicalisation, such constructions have acquired the characteristics of compounds: in terms of referentiality, the possessor in these expressions is not fully referential. Indeed, a co-reference with a pronoun is unacceptable (e.g. **I saw Halley's comet, he is great*). Nor is it possible to ask about the identity of the possessor (e.g. **whose comet did you say you had seen?*). In *Parkinson's disease* in comparison with *John's disease*, *Parkinson*, as an individual, does not serve as a point of reference (i.e. it is not *Parkinson* that has the disease; e.g. **whose disease are you talking about?*), whereas for *John's disease*, it is of course appropriate to ask (e.g. *whose disease are you talking about?*) as the construction requires previous knowledge of *John*. As already mentioned, the expressions in (106) have generic meanings. Although the first element is a specified individual, it serves as a type rather than an individual (e.g. *St Valentine's Day* refers to *a day associated with love*). These terms also are not open to pragmatic considerations as they have conventionalised forms and meanings and can be found listed in dictionaries. Moreover, onomastic possessives accept initial adjectives that modify the entire construction (107), a feature that is not available for prenominal possessives (108):

- (107) a. We watched in vain for the much-talked-about [_NHalley's comet].
b. Some progress has been made in treating the debilitating [_NParkinson's disease].
c. We were faced by the usual [_NHobson's choice.]

- (108) a. *the loquacious [John's aunt]
 b. *the debilitating [Dr Parkinson's disease]
 c. *the sprained [Jill's ankle]
 ((107) & (108) are taken from Taylor, 1996, p. 296)

There is some sort of gradience with onomastic possessives; some are closer to the status of prenominal possessives in terms of definiteness (e.g. *Beethoven's Ninth*, *Schubert's Unfinished*, *Dante's Inferno*), whereas much lower topical structures (e.g. *Achilles' heel*, *Adam's apple*) are closer to possessive compounds. For the latter, onomastic possessives are not restricted to the context and must be preceded by a determiner; without it, the examples are unacceptable (Taylor, 1996, p. 269):

- (109) a. Status is the businessman's Achilles' heel.
 b. *Status is Achilles' heel for the businessman.
- a. Fred has a protruding Adam's apple.
 b. *Adam's apple is protruding.
 (Taylor, 1996, p. 297)

I shall return to the issue of gradience in the next chapter (§ 2.1), when discussing the variability of the use of the possessive morpheme inside compounds.

6. CONCLUSION

This chapter has investigated the theoretical status of inflection. Three perspectives have been assessed:

- i. All inflections are formed extra-lexically (Anderson, 1982, 1992).
- ii. All inflections are formed in the lexicon (Booij, 1994, 1996, 1998).

- iii. Only productive inflections are formed extra-lexically (Perlmutter, 1988).

Anderson's position representing the strong version of the split morphology hypothesis cannot be upheld. It is challenged by two observations. First, there are deep similarities between inherent inflections and derivational inflections (Booij, 1998, 1996, 1994). Second, Perlmutter (1988) observed that idiosyncratic inflections may precede derivational inflections in Yiddish.

Booij provided strong evidence that inflections with inherent properties should not be demarcated from the morphological component. However, the result of his discussion is equivocal; contextual inflections are distinct from inherent inflections, thereby leaving a gap for Perlmutter's position that represents the weak version of SMH. The chapter examined further the validity of Perlmutter's theory by investigating the properties of the possessive affix in English. Two theories were discussed:

- i. The possessive affix is a clitic (or phrasal affix), motivated by its appearance at the right periphery of the possessor phrase (Anderson, 2008, 2013).
- ii. The possessive affix is a lexical inflection (e.g. Bermúdez-Otero & Payne, 2011; Payne, 2009; Halpern, 1995; Zwicky, 1987).

The chapter assessed the second position as stronger. Three phenomena were discussed as evidence: (i) the idiosyncrasy of the possessive pronoun, (ii) the sensitivity of the possessive morpheme to the

morphological properties of its host word and (iii) the appearance of the possessive morpheme inside compounds. In fact, the third phenomenon was more controversial because another issue concerning the status of the N's-N construction had to be addressed. Anderson (2013; PC, 2009) claimed that it is a syntactic construction, while Shimamura (2000) claimed that it is a fixed expression. For both claims, the N's-N construction does not threaten the syntactic theory of the possessive affix. In (§ 5.3), possessive compounds, albeit less productive, are demonstrated to have the hallmarks of noun-noun compounds, semantically and structurally. They also share the same problem of fuzziness; they bear characteristics from morphology and syntax. In addition, the criteria employed for N-N sequences to draw a sharp distinction between phrases or words are questionable, so it is biased to argue that a possessive compound is either a syntactic structure or a reanalysed phrase. While the above analyses cannot be ignored due to the fuzzy nature of compounds, the possessive compound as a lexical rule like any lexical noun-noun compound cannot be ignored either and, consequently, the presence of the possessive affix inside a lexical rule invalidates Perlmutter's SMH (1988). Booi's (1994, 1996, 1998) lexical approach to inflections will be maintained.

The ultimate result of this chapter is that inflections are part of the morphological component. In Giegerich's (1999) theory of lexical stratification, the assumption that the regular inflection is formed at stratum 2 along with compounding is maintained. Based on the previous discussion,

this also includes the possessive affix, thereby allowing both inflectional affixes to interact with compounding, although not freely. The stratal model does not impose a restriction on the interaction. I will elaborate on this in the next chapter, which studies the motivation for the appearance of the possessive and the regular plural inside compounds within the BDS model.

CHAPTER III

THE FUNCTION OF THE REGULAR PLURAL INSIDE ENGLISH COMPOUNDS

This chapter argues that the regular plural can be an ambiguity resolver, a function that motivates it to interact with compounding at stratum 2 of the base-driven stratification model.

Chapter I discussed that the base-driven stratification model, which operates by placing the regular plural with compounding at the same stratum, allows for free interaction between both rules. Chapter II settled the problem of the place of the regular plural in grammar; it is correctly sited at stratum 2, along with compounding. The problem raised in chapter I, however, requires the interaction to be restricted in order to avoid the generation of ill-formed compounds (e.g. **cats lover*).

However, the semantic value of the regular plural is a subject of debate. Lieber and Stekauer (2009) claimed that the regular plural should be considered a linking element because it is purposeless. Other researchers argued that its function is to impose either the plural interpretation (Selkirk, 1982) or the heterogeneous sense of the non-head noun (Sproat, 1985; Alegre & Gordon, 1999). I contribute to this argument by arguing that, although heterogeneity is a very important factor for motivating the appearance of the regular plural, other factors exist, as well. All the factors are related to the ambiguity that results from the phenomenon of polysemy.

I will also deal with two problems encountered in the research: (i) the confusion between the regular plural and possessive inflections inside compounds and (ii) the confusion between the regular plural and a class of pluralia tantum called 'pluralia tantum in specific sense only' (as identified by Johansson, 1980, p. 49).

The structure of this chapter is as follows: In (§ 1), I will discuss Lieber and Stekauer's (2009) argument that the regular plural is a linking element. This will include a review of linking elements in German compounds (§ 1.1), followed by a discussion in (§ 1.2) that the justifications for the semantic emptiness of German linking elements are strong, while Lieber and Stekauer's justification is weak in the case of English compounds.

In (§ 2), the motivation for the possessive inflection inside compounds will be discussed, followed by a review of the pluralia tantum in English and their occurrences within compounds in (§ 3), with specific focus on pluralia tantum that might be confused with the regular plural. In (§ 4), pre-modified regular plurals inside compounds will be considered. I argue that such constructions should be excluded to give a reliable account for the appearance of the internal regular plural.

The semantic function of the regular plural will be discussed in (§ 5). Four categories of polysemy are involved: type/ token polysemy, mass/ count polysemy, text/ object polysemy, and adjective/ noun polysemy. The chapter ends in (§ 6) with a discussion on the interaction between the regular plural and compounding.

1. THE MEDIAL S AS A LINKING ELEMENT

The left member of most English compounds is in the singular form, which is preferred even if the plural interpretation is intended; 'The singular as a rule is used even if the idea is plural' (Jespersen, 1954, p. 185). However, the neutrality of the non-head noun is challenged by two phenomena. The first is the acceptability of unproductive plurals inside compounds (e.g. *mice chaser*, *teeth cleaner*, *humanities department*), which has a straightforward account within lexical stratification models; unproductive plurals are formed at stratum 1, which can feed into compounding at stratum 2 (Giegerich, 1999; Kiparsky, 1982)⁷¹. Second is the unusual appearance of the regular plural within some compounds, the functional value of which is debated.

Selkirk (1982, p. 52) suggested that the internal regular plural serves a semantic function; its use within compounds is to impose the plural interpretation of the non-head because a singular interpretation is possible, and this explains the contrast between *programme coordinator* vs. *programmes coordinator* and *private school catalogue* vs. *private schools catalogue*. In these cases, the semantics of the head does not play a role in the disambiguation and, without the plural inflection, the compounds may refer to *a coordinator of one programme* and *a catalogue of one private school*.

Lieber and Štekauer (2009), on the other hand, hold that there is no real purpose for using the plural form within compounds because the first element is already generic (e.g. it is impossible for a *dress manufacturer* to

⁷¹ See (Chapter I, § 3) for detailed discussion on regular/ irregular plural dichotomy.

refer to a *manufacturer of only one dress*). Lieber and Štekauer were critical of Selkirk's account, because it does not explain the contrast between *programmes list* and *programme list*, as the head noun *list* clearly forces the plural interpretation of the non-head. They point out there is no ambiguity in examples like *programme list* that necessitate the use of the internal regular plural morpheme and, accordingly, the ambiguity is ultimately related to the issue of the linking element:

The issue of compound-internal inflection is inevitably bound up with that of so-called linking elements...a linking element is a meaningless extension that occurs between the first and second elements of compounds.

(Lieber and Štekauer, 2009, p. 13)

This implies that the regular plural inflection inside English compounds is a meaningless extension, just like the connective elements found inside German compounds.

The following section provides a brief review of the linking elements in German compounds, focusing on their historic origins and the reasons for considering them meaningless. It will be argued in (§ 1.1.3) that Lieber and Štekauer's (2009) claim cannot be maintained. As Selkirk suggested, the internal regular plural has a semantic value; this will be further discussed later in the chapter.

1.1 Linking Elements in German N-N Compounds

In German compounds, a compound-specific inflection known as a linking element is found between the immediate constituents of a noun-noun

compound. It belongs to the first constituent, as shown in the ‘coordination reduction’ in (1) below, but it cannot appear in the first constituent when it occurs as a free form (Neef, 2009, p. 390):

- (1) Kapitänsmützen und Admiralsmützen ‘caps of captains and admirals’
Kapitän- und Admirals+mützen
*Kapitän- und Admiral+ smützen

A nominal compound in German may or may not contain a linking element⁷². Six forms can be found in the juncture position: -e- *Mäuseplage* ‘plague of mice’, -er- *Kindergarten* ‘kindergarten’, -en- *Frauenfrage* ‘women’s issue’, -n- *Seidenkleid* ‘silk dress’, -es- *Kindesalter* ‘childhood’ and -s- *Gleichheitsprinzip* ‘principle of quality’, but in *Buchhandlung* ‘book shop’ the non-head appears in its unaltered singular form (Montgomery, 2001, pp. 150–151). Historically, linking elements originated from genitive singular forms for masculine and gender-neutral nouns or plural suffixes (Wegener, 2008).

1.1.1 Linking elements as relics of the genitive singular inflection

(-es, -s, -en, -e)

Some linking elements correspond in form to the genitive singular inflections for masculine and gender-neutral nouns (e.g. *des Tages*, *des Kindes*, *des Stachels*, *des Parks*) (Montgomery, 2001, p. 156). It is widely accepted that genitive noun phrases were subject to the process of lexicalisation resulting

⁷² Only nouns and verbs as first constituents can take a linking element (Neef, 2009, p. 390).

in the evolution of genitive compounds in the period of Early New High German (Wegener, 2008). For example, *Friedhofsmauer* 'cemetery wall' was originally the genitive noun phrase *des Friedhofs*_{Gen.Sg} *Mauer*; similarly, *Hahnenschrei* 'cock-crow' was originally *des Hahnen*_{Gen.Sg}, and its new genitive form now is *des Hahns* (Dressler, Libben, Stark, Pons, & Jarema, 2001, p. 187). According to Wegener (2008, p. 335), the process of lexicalisation has affected the following:

- i. The interpretation of the left constituent, from referential to generic.
- ii. The function of the genitive inflection; it is called now a linking element.
- iii. The orthography; the compound is written as one word.
- iv. The article, from the genitive form to a nominative form that agrees with the head of the compound (e.g. *des Kindes Vater* 'the father of the child' → *der Kindesvater* 'the child's father').

Regarding the semantic function of the linking element, there are two views. First, it has a genitive meaning, supported by the match between form and meaning (e.g. Augst; Gallmann, as cited in Neef, 2009, p. 390). The linking elements in the following examples correspond to the genitive form and bear the genitive meaning.

- (2) *Landsmann* 'compatriot' (i.e. a man from the same country)
Landesregierung 'regional government' (i.e. of one land)
(Dressler et al., 2001, p. 187)

The second and the more dominant argument is that the linking element lost its genitive meaning and it is just a connective element (e.g.

Ramers; Fuhrhop; Becker, as cited in Neef, 2009, p. 390; Montgomery, 2001; Aronoff & Fuhrhop, 2002⁷³). This is supported by a non-paradigmatic linking element. The historic genitive inflection *-s* has further developed to appear as a pure linking element. The semantic emptiness of the linking elements is very clear in compounds like those illustrated in (3), where they are not the same as any endings in the paradigm of the bases to which they attach:

- (3) *Liebesbrief* 'love letter'
Arbeitsamt 'employment office'
 (Bell, 2012, p. 140)

The linking element *-s-* in (3) does not correspond to the genitive inflection. *Liebes* and *Arbeits* are morphologically incorrect; they are feminine nouns to which the suffix *-s* never attaches⁷⁴ (*Liebe*_{Gen} and *Arbeit*_{Gen}/*Lieben*_{PL} and *Arbeiten*_{PL}) (Collins Online German-English Dictionary).

⁷³ Aronoff and Fuhrhop (2002), however, argued that while it is true that these interfixes are devoid of meaning, not all of them are without function. The second type of linking element is what Aronoff and Fuhrhop (2002, pp. 461–462) classified as 'independent linking elements'; it patterns productively, but deviates from the inflectional system in the sense that it has the plural form but is devoid of the plural meaning. It includes two linking elements:

-s- and *-(e)n-*. The linking element *-s-* attaches to 6 suffixes: *-heit*, *-igkeit*, *-keit*, *-ling*, *-schaft*, and *-ung*; *-n-* attaches to suffixes ending in schwa; *-(e)n-* comes after weak masculines and words ending with the suffix *-in*. With the exception of *weak masculines* and the suffix *-schaft*, the remaining forms are considered as closing suffixes that prevent their stems from involving any further morphological processes; for example, the word **Schönheitlich* is ungrammatical because it contains the closed stem *Schönheit* 'beauty'. This is the important function of the linking element whose presence 'reopens' closed stems to involve compounding (e.g. *Schönheit+s+pflästerchen* 'beauty-patch'). The distribution differs in the case of *-n-* following the schwa. The schwa can be either an ending or a derivational suffix. The stem with the latter does not undergo any further morphological processes. The schwa has a different analysis (see Aronoff & Fuhrhop, 2002, pp. 462–464 for discussion). For a possible phonological function, see Nübling and Szczepaniak (2008).

⁷⁴ The *-s* suffix is normally found on nouns of foreign origin (e.g. *der Cousin* (from French) 'the cousin' → *die Cousins*), and feminine nouns generally take either *-en*, which is very productive (e.g. *Schule* 'school' → *Schulen*), or *-nen* for nouns ending with *-in* (e.g. *Doktorin* → *Doktorinnen*) (Graves, 1990, pp. 41–42).

1.1.2 Linking elements as relics of the plural inflection (-er, -e, -(e)n, -s)

Linking elements can also correspond to nominative plurals⁷⁵, and hence Wegener (2008) and Neef (2009) argue that they originate from plural suffixes⁷⁶. It is clear that the linking element *-er-* corresponds to the regular inflection, while *-s-* and *-(e)n-* might be confused between the genitive and plural inflections (Wegener, 2008). The semantic function of this type of plural inflections (Wegener, 2008). The semantic function of this type of linking element is also under debate. One view claims that it has a plural meaning (e.g. Augst, as cited in Neef, 2009, p. 390; Clahsen, Marcus, Bartke, & Wiese, 1996); for support, they note the match between form and meaning. According to this view, the linking element is not only identical to the plural morphology but also bears a plural interpretation. *Länderspiel/ match/ kampf* ‘match between two nations’ and *Länderkunde* ‘political geography’ (i.e. ‘of more than one country’) are examples of this (Dressler et al., 2001, p. 187), as are compounds such as *Hunderennen* ‘dog racing’ (Neef, 2009, p. 390).

⁷⁵ The nominative plural and the genitive plural suffixes in German are identical (Wegener, 2008), as can be seen in the following examples: Nom.Pl./ Gen.Pl: *Ø die Brüder/ der Brüder*; *-e die Hände/ der Hände*; *-er die Männer/ der Männer*; *-en die Antworten/ der Antworten*; *-n die Schulen/ der Schulen* and *-s die Parks/ der Parks*) (Graves, 1990, pp. 37–42). Modern German lacks genitive plural suffixes; thus, we can rule out the possibility that linking elements in the examples below originated from the old genitive system.

(A)	i.	der Kind- er Krankheit	die Kinder-krankheit
		of the children-GEN.PL illness	the children-illness
		the illness of the children	the children’s illness
	ii.	der Hund- e Meute	die Hunde-meute
		of the dogs-GEN.PL pack	the dogs-pack
		the pack of dogs	the pack of dogs
			(Wegener, 2008, pp. 336).

⁷⁶ Cf. Wegener (2008), who argued that such linking elements did not originate from plural suffixes.

Moreover, Montgomery (2001, pp. 224, 226) observed that the linking element *-er-* in gender-neutral and masculine monosyllabic native words (e.g. *Kind* and *Mann*, respectively) forces a plural semantic interpretation (e.g. *Kinderabend* 'kids evening', *Männerfrage* 'men's issues'). There is even a pair of opposing compounds, one with a bare non-head corresponding to the singular interpretation and the other with a plural suffix on the non-head whose plural meaning is recognisable (e.g. *Arztpraxis* 'doctor's office' vs. *Ärztepraxis* 'doctors' office')⁷⁷.

The semantic necessity of a linking element with a plural meaning, however, is put to question by two contrasting observations. First, the meaning of the left constituent is generic; many compounds in German do not contain plural linking elements, but the plural interpretation is possible. For example, *Autosammlung* 'car collection' (Neef, 2009, p. 391), and *Buchhändler* 'book seller' (Wegener, 2008, p. 336). The second observation is that the linking element corresponds to the plural suffix, but yet the singular interpretation is imposed (Koester, Gunter, Wagener, & Friederici, 2004; Wegener, 2008). For example, *Kinderstar* 'child star', *Kindergesicht* 'child's face', *Bilderrahmen* 'picture frame', *Kleiderbügel* 'coat hanger', and *Hühnerei* 'hen's egg' (Wegener, 2008, p. 336). Montgomery (2001) pointed out that the suffix *-er* in *Kindergarten* has the plural interpretation, but with the existence

⁷⁷ Montgomery (2001, p. 219) observed that the plural linking element *-e-* attaches to monosyllabic Germanic words and, in cases where variants exist, such as *Schwansammler* 'swan collector' vs. *Schwänesammler* and *Fußfrage* 'foot question' vs. *Füßefrage*, compounds with bare nouns are always preferred.

of compounds such as *Kinderstar* 'child star', where the same suffix has no meaning and the generic reading of the non-head exists in all compounds, one can argue that the *-er* in *Kindergraten* is not a plural morpheme but a linking element.

Having reviewed the main aspects of the linking elements in German and the main claims related to them, I will argue in the following section that the regular plural morpheme cannot be related to the linking elements.

1.2 The Regular Plural inside English Compounds is not a Linking Element

A few numbers of English compounds, especially those ending with *-man*, have an internal *s* that originates from the older genitive form *-es* (Bergesten, 1911, p. 114):

- (4) a. kinsman OE caynnes mann
- b. steersman OE steóres mann
- c. townsman ME tunes man
- d. craftsman ME craftys man

During the process of development, the genitive marking has lost its meaning and function and is seen now as residue from the older system. Other constructions have acquired the connective element by analogy (e.g. MnE *daysman*, *spokesman*, *oddsman*, *eightsman*, *thirdsman*, *oversman*) (Bergesten, 1911, p. 115). According to Montgomery (2001), the linking element in these compounds has no recognisable morphological, phonological or semantic

reason, and the limited number of compounds having this connective element makes them eligible for listing in the lexicon.

In German, the linking element that corresponds to the regular plural and has a plural meaning is semantically empty. This claim is justified by two features:

- i. The plural interpretation is understood even in the absence of the plural inflection
- ii. In some cases, with the presence of the plural suffix, the singular interpretation is forced.

The first observation is evident in English; the plural interpretation might be understood with the absence of the plural suffix (e.g. *book shelf*, *cat lover*, *painting collection*, etc.). The semantic emptiness of the regular plural would strongly have been supported if the second feature had applied to English compounds. The left constituent of the compound *programmes list* discussed in Lieber and Štekauer (2009, p. 13) is clearly plural.

However, Lieber and Štekauer's (2009) main point is that the absence of a satisfactory explanation for their occurrence is the reason for relating the issue of plurality to that of the linking element. For example, there is no difference in meaning between examples such as *programmes list* and *programme list*. According to them, the plural morpheme is likely unnecessary because the semantics of the head is sufficient to disambiguate the number interpretation of its non-head. However, this claim does not take into account three observations:

- i. The main function of the plural suffix is not to reflect the number opposition (i.e. *many a programme*) that accounts for the unacceptability of **trucks driver* or **claws marks*, but rather to clarify ambiguity between *programmes* as tokens or types, and the use of plurality has been employed to clarify the latter, i.e. a list of various types of programmes.
- ii. The occurrence of the regular plural in opposing compounds such as *drug-induced* and *drugs induced* does not mean that the medial *s* is a meaningless extension, as ambiguity here plays a role in the use of the plural suffix. Bauer and Renouf (2001, p. 116) suggested that in this pair we are dealing with two homonyms in *drug*, as a legal or illegal substance; the use of the plural imposes the meaning of illegal drugs, as ‘a drug-induced sleep would be something ordered by the doctor, and the drugs-induced teenage rampage that we are dealing with in this text is clearly related to drug abuse’.
- iii. Moreover, Lieber and Štekauer (2009) discussed the example of *private schools catalogue*. The first element of the compound is separately modified, which indicates that we are dealing with a phrase embedded inside compounds and the appearance of the plural in this case is normal. Consider, for example, compounds like **rats eater* vs. *red rats eater* or *?books shelf* vs. *new books shelf* (Alegre & Gordon, 1996).
I return to this topic in (§ 4).

The counter-argument to Lieber and Štekauer's (2009) claim will be discussed in detail in (§ 5). However, before analysing the semantic function of the regular plural, it is necessary to address the fact that the regular plural might be confused with two homophonous morphemes that happen to appear inside compounds: the possessive affix and a type of pluralia tantum called 'pluralia tantum in specific sense only'.

2. THE MEDIAL S AS A POSSESSIVE MORPHEME

One possibility raised by Taylor (1996) is that the *-s* in the juncture position in possessive compounds can be analysed as a regular plural. In many cases, the plural morpheme is obviously contained; in others, it might be difficult to tell whether it is possessive or non-possessive (Krstev, Vitas, & Savary, 2006, p. 558). The medial *s* in N-*s*-N would be analysed as either a regular plural, a possessive, or a regular plural + possessive. For example, the morpheme inside *students union* raises three possible forms: *students union* (regular plural), *student's union* (a possessive), and *students' union* (regular + possessive). Of course, for nouns lacking plural number or irregular plural nouns, the analysis of the medial *-s* as a possessive marker is straightforward (e.g., *the earth's interior*, *children's playground*).

The orthographic practice should not be relied upon to resolve the confusion. Examples of variations in the use of the possessive apostrophe were reported by Taylor (1996, p. 305), who noted shop signs reading *boys shoes*, *boys' shoes*, and *boy's shoes*; *girls dresses* and *girls' dresses*; and *ladies*

fashions and *ladies' fashions*. He also found in the Collins English Dictionary the entry of *magistrates' court*, but found *Magistrate's Court* in COBUILD, while Barfoot (1991, p. 124) found *Magistrates Court* in Margate and elsewhere. Barfoot (1991) also found *Readers Admissions Office* inside the British Museum and *St. Mildreds Café* and *St. Mildreds Gardens* in Westgate. Taylor (1996) suggested that such variations do not reflect people's failure to adhere to the rules governing the use of the possessive apostrophe⁷⁸.

The aim of this section is to investigate the factors that motivate the use of the possessive inflections inside compounds. It is an important step for the present research before analysing the semantic function of the regular plural inside compounds to avoid confusion between the two inflections.

⁷⁸ Sklar (1976) provided a historical review of the development and decline of the possessive marker. The apostrophe in the genitive singular was first used in the late sixteenth century; its use remained stable until the end of the seventeenth century, when some grammarians restricted the use of the apostrophe to its original function of denoting elision and did not follow its rule as a possessive marker. Sklar cited Gildon and Brighton's dedication to their book *A Grammar of the English Tongue* (1711), which says 'To the Queens most Excellent Majesty' (p. 177). In the middle of the eighteenth century, consensus emerged on the use of the apostrophe for the genitive singular as some grammarians viewed 's to be a contraction of the genitive pronoun *his*, yet confusion persists with the genitive plural due to the existence of another homophonous morpheme: the regular plural *-s*. One solution is to insert the apostrophe before the plural morpheme; however, this solution is problematic as it makes the genitive plural and the genitive singular noun identical. Some grammarians have suggested that the apostrophe for genitive plurals should not be used. According to Sklar (1976, p. 179), Joseph Priestly was the first to formulate a rule governing the use of the genitive apostrophe for both singular and plural nouns in modern times:

The genitive case ... is formed by adding [s] with an apostrophe before it to the nominative; as Solomon's wisdom; The Men's wit; Venus's beauty; or the apostrophe only in the plural number, when the nominative ends in [s] as Stationers' arms.

Nevertheless, evidence of confusion in the use of the possessive marker—especially for the plural noun—is found in newspapers, on menus, in commercial advertisements, etc. Sklar (1976) cited examples from different sources to demonstrate this confusion (p. 181). For example, *these player's money* was used in a cartoon strip, *Come to Parent's Night* was an invitation issued to parents by a childbirth association, and a statement from the *New York Times* said 'some of the hospital staff had objected to having the film made on location ... for fear that it might infringe on the patient's right to privacy'.

The previous chapter explained that possessive compounds and noun-noun compounds share a number of features, including the fact that the nominal dependents of both constructions are type restricted and affect the referentiality of the dependents. The nominal dependent in the prenominal possessive, on the other hand, is token-restricted. This feature allows it to serve as a reference point (Taylor, 1996; Rosenbach, 2008). In this section, we shall see that the possessive inflection is motivated by the animacy of the left constituent, and this is what distinguishes possessive compounds from noun-noun compounds. Meanwhile, animacy is a feature shared by possessive compounds and prenominal possessives.

2.1 Distribution of the Possessive Inflection inside Compounds

(i) *Semantic relationship*: Taylor (1996) observed that the possessive morpheme is prohibited if the semantic relation of the non-head to the head noun is of a thematic nature, especially in the relation of patient, which is a semantic relationship found in synthetic compounds. For example, a person who molests children is *a child molester* not **child's molester*. The possessive morpheme is also ruled out if the two constituents describe the same thing or person (i.e., they are in apposition). Consider the pair *woman doctor* and *woman's doctor*; if the intended meaning is *a doctor who is a woman*, then *woman's doctor* is ungrammatical and the possessive morpheme must be excluded; in this case, *woman doctor* is correct. The possessive morpheme is

retained if the intended meaning is *a doctor for women* (i.e., *woman's doctor* or *women's doctor*) (Taylor, 1996, p. 303).

(ii) *Animacy*: Taylor (1996) notes that there is a strong correlation between animacy and the appearance of the possessive on the non-head. The standard notion in grammar books is that the possessive inflection attaches to human possessors. This can be observed in most prenominal possessives as the possessor nominal is human or animate (e.g., *the woman's car*). According to Taylor (1996), animacy is a more reliable motivation for the use of the possessive morpheme within compounds. The simplest definition of the concept of animacy is the distinction between living and non-living things or concepts. The examples in (5) illustrate this correlation.

(5) man's shop (*man shop), woman's college, child's play, driver's licence, Mother's Day, housemaid's knee, writer's cramp, master's degree, witch's broth, printer's ink, potter's wheel, shepherd's pie, ploughman's lunch

(6) woman's magazine vs. girlie magazine (*girlie's magazine)
(Taylor, 1996, p. 303)

For the exception in (6), the semantic relationship between the head and the non-head of the compound possibly accounts for the prohibition of the possessive morpheme in *girlie magazine*. The *magazine* in *woman's magazine* is identified by people who are likely to read it (i.e., female readers), whereas it would be impossible for *magazine* to be identified by the people who appear in it (**girlie's magazine*).

For non-human animates, inconsistency emerges in the use of the possessive morpheme within nominal compounds (Taylor, 1996, p. 304):

- (7) a. hen's egg (*hen egg), bird's egg (*bird egg) **vs.** ostrich egg (*ostrich's egg), goose egg (*goose's egg), fish egg (*fish's egg)
 b. lamb's wool (*lamb wool) **vs.** horse hair (*horse's hair)
 c. pig's trotter (*pig trotter) **vs.** chicken breast (*chicken's breast)
 d. bird's nest (*bird nest), lion's den (*lion den) **vs.** dog kennel (?dog's kennel)
 e. duck's egg=duck egg, sheep's liver=sheep liver

On the other hand, inanimacy and abstractness of the non-head generally prohibit the possessive morpheme from showing up, as in (8):

- (8) nature reserve (*nature's reserve), letter box (*letter's box), bicycle wheel (*bicycle's wheel)

However, consider the following exceptions:

- (9) ship's engine (?ship engine) **vs.** car engine (*car's engine)

- (10) baby carriage (*baby's carriage)

((8), (9), & (10) taken from Taylor, 1996, p. 303)

The elaborated notion of animacy is necessary to address the discrepancies illustrated in (9) and (10). Quirk et al. (1985) defined the concept of 'gender hierarchy', in which nouns are classified with regard to the patterns of pronoun co-reference for singular nouns, as represented in Figure 1:

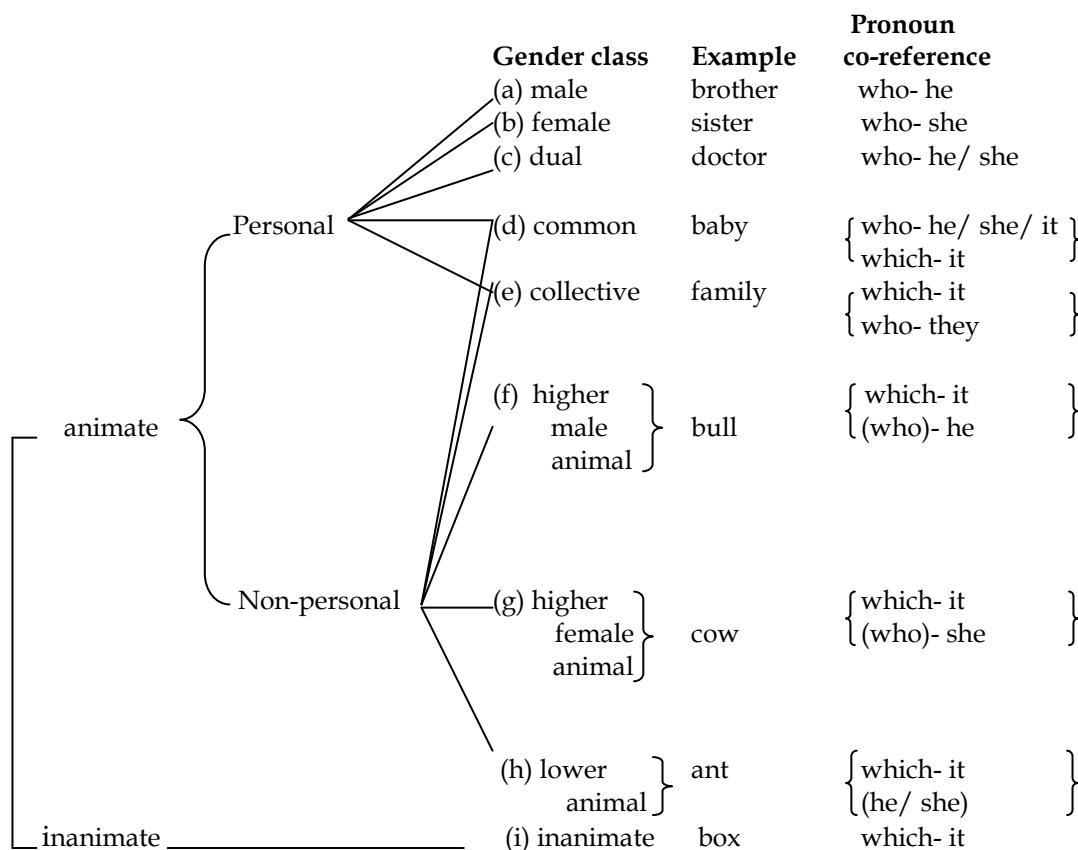

Figure 1: Quirk et al.'s (1985) classification of gender

In terms of the exceptions in (9) and (10) above, Taylor (1996) suggested that Quirk et al.'s (1985) gender hierarchy might account for the use of the possessive morpheme for a noun like *ship*, which is placed at a higher ranking than other non-animate nouns in the hierarchy, as it can be substituted with *she*, thereby making it possible to bear the genitive inflection. Meanwhile, *baby* can be replaced with *it*, as it occupies a lower level than any other human class in the hierarchy (Taylor, 1996, p. 304).

In the line with the above analysis, Dabrowska (1998) argued that nouns metaphorically understood to be human, such as computer nouns, are very likely to feature the s-genitive. Computers can mimic human activities;

for instance, information can be stored in a computer's 'memory', computers 'give' instructions and computers can be 'malicious' (Rosenbach, 2002, p. 49). Rosenbach (2002) further argued that computers can also be conceived as a locational noun; for instance, someone can be said to be 'within' a programme or moving to another one (p. 49).

The analysis of computer nouns being metaphorically animate is consistent with what Rosenbach (2002) observed in the experimental study she conducted to investigate the distribution of s- and of-genitives. As Table 1 indicates, Rosenbach (2002) ascertained that the s-genitive was constantly used in conjunction with the noun *car*, which she suggested might be due to the fact that some people care about their cars and give them names as if they were truly animate. However, the frequency of the use of s-genitive with the noun *car* for younger British subjects was significantly higher than for older British subjects, suggesting that use of s-genitives with inanimate nouns has increased in modern times.

Table 1: Items with car as possessor (adapted from Rosenbach, 2002, p. 172):

Items with car as possessor	Relative frequency of s-genitive for younger British subjects	Relative frequency of s-genitive for older British subjects
The car's security system	88.9%	85%
The car's bonnet	63.9%	50%
The car's wings	37.1%	30%
The car's condition	38.9%	40%
a car's headlamps	61.1%	45%
a car's silhouette	27.8%	0%
a car's fumes	44.4%	0%
a car's driver	2.8%	5%

For other inanimate nouns accepting the possessive morpheme, Quirk et al. (1985, p. 324) classified such nouns into four categories in an attempt to find some sort of systemacity. These categories are described below:

- | | | |
|---------|---|---|
| (11) a. | Geographical names | <i>Continents</i> : Europe's future
<i>Countries</i> : China's development |
| b. | Locative nouns | The earth's interior
The city's atmosphere |
| c. | Temporal nouns | A day's work
A moment's thought |
| d. | Other nouns of special
relevance to human activity | Science's influence
Love's spirit |

The change towards the use of the possessive inflection with inanimate nouns has also been attributed to dialectal influence—most specifically, American English (Rosenbach, 2002). Jahr Sorheim (1980) compared the British Lancaster-Oslo/Bergen corpus (LOB corpus) with the corresponding American Brown corpus. She found that, in American texts, there is an increase in the use of the possessive inflection with inanimate nouns, and this use has spread to British English, especially in newspaper texts, albeit less so in religious texts as the latter is still regarded as a formal genre. Moreover, Hundt (1998) conducted an empirical study to investigate the effect of dialectal variation on the use of s-genitive with inanimate possessors. He analysed British, American, New Zealand, and Australian newspaper corpora and found that “AmE is leading the change towards a greater use of inflected genitives with nouns ranking low on the gender

scale” (Hundt, 1998, p. 46). He also found that New Zealand and Australian varieties follow BrE in relatively resisting the change.

According to Rosenbach, although there is a trend towards using the possessive inflection with inanimate nouns, her frequency study confirmed Taylor’s argument (1996) that animacy still regards the decisive factor for its use inside compounds. She examined the frequencies of 20 pairs of possessive and non-possessive compounds: 10 pairs having animate dependents (e.g., *driver’s licence* versus *driver licence*) and 10 pairs having inanimate dependents (e.g., *museum’s shop* versus *museum shop*). The results as shown in Figure 2 below:

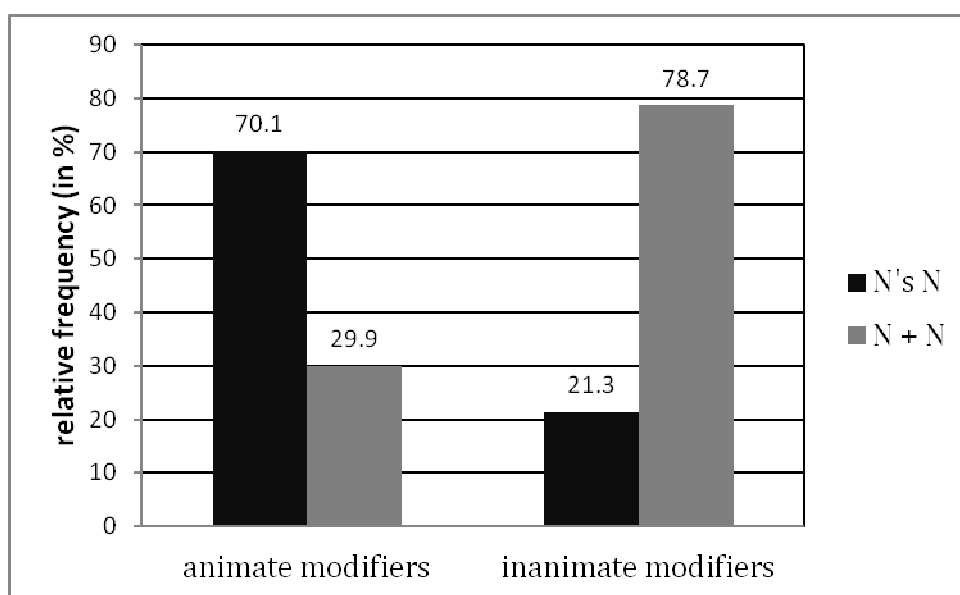

Figure 2: Relative frequency of possessive compounds and noun-noun compounds according to animacy

The possessive morpheme is strongly favoured within a compound if the non-head is animate (70.1%), whereas inanimate non-heads are strongly favoured within N+N compounds (78.7%).

Interestingly, for compounds with animate modifiers, the use of the possessive inflection inside a compound is not categorical.

- (12) Driver's seat **vs.** passenger seat (*passenger's seat)
Children's room **vs.** guest room
Insider's report **vs.** insider report
(Taylor, 1996, p. 309)

Taylor (1996) and Rosenbach (2007) suggested that referentiality might play a role. *Driver* can refer to a particular person; its degree of referentiality is higher than *passenger*, as the latter can refer to anybody and hence motivate the reading of an instance rather than a type. Similarly, the possessive morpheme in *children's room* identifies specific individuals (the children of the family), but it is omitted in *guest room*, which does not refer to specific guests but rather to anybody who happens to be a guest. Regarding the pair *insider's report/insider report*, the former enhances the interpretation of a report presented by a specific person whereas the latter refers to a report not presented by a specific insider. In other words, *insider's report* enhances the concept of an instance and accepts co-reference, as illustrated below (Taylor, 1996, p. 309):

- (13) a. We now bring you a disturbing insider_i's report, in which he_i describes the latest happenings in the country.
b. *We now bring you a disturbing insider_i report, in which he_i describes the latest happenings in the country.

The variation in the use of the possessive inflection inside compounds becomes even more complicated with examples like the following:

- (14) a. driver's licence/driver licence
 b. cow's milk/cow milk
 c. Molotov's cocktail/Molotov cocktail
 d. the student's essay/the student essay

According to Taylor (1996, p. 311), possessive compounds are no longer preferable as they are being supplanted by a tendency towards 'conventionalisation'. For example, the genitive compound *doll's house* is found in OED, but in COBUILD it is *doll house*. OED also includes the entry *dog's ear*, while Collins—a more modern dictionary—records *a dog-ear*. In cognitive grammar, a possessive compound like those in (14) is seen as a gradient phenomenon which can be represented in the form of a continuum whereby it begins with a prenominal possessive with definiteness, passes by a prenominal possessive with indefiniteness and by a possessive compound, and finally ends with a non-genitive compound (Taylor, 1996, p. 311):

- (15) a. [the driver]'s licence → [a driver]'s licence → a [driver's licence]
 → a [driver licence]
 b. [the student]'s essays → [a student]'s essays → [the students'
 essays] → [the student essay]

For the BDS model, two potential explanations can be given for the blurred nature of possessive compounds. First, possessive compounds are syntactic structures; they might have gained access to lexicon, thereby becoming lexical without an abrupt change in their characteristics as the process of change in the form and meaning is gradual (Giegerich, 2004). The second explanation, and the one the present research supports as a result of the discussion in Chapter I (§ 1.1) and II (§ 5.3), indicates that (i) possessive compounds might be coined in the lexicon; and (ii) the syntactic

characteristics of these constructions follow from the speculation that stratum 2 somehow overlaps with syntax (Giegerich, 2005). In addition, the variation in the use of the possessive inflection might be attributed to speakers' specific use of language, as will be discussed in the following section.

2.2 Possessive Compounds and the BDS Model

According to Lieber's (2004, 2009) analysis of compounding, discussed in Chapter I (§ 2.3.3.5), the mechanism of co-indexation is strong if it achieves full identification of the reference if the co-indexed items share identical skeletal features and major bodily attributes. If the co-indexed items are different, co-indexation will only create the meaning of 'association' between them, thereby allowing speakers to determine the ultimate interpretation of the compound by using their encyclopaedic knowledge, context, or preference. In the BDS model, the possessive inflection is assigned to stratum 2 along with compounding, and here Lieber's analysis will be tentatively used to demonstrate the interaction between both rules.

a. [dog hair] vs. [dog's hair]: The lexical items *dog* and *hair* are projected into stratum 2 for compounding to form *dog hair*. The semantic features of the skeletons and bodies of these items are substantially different. The mechanism of co-indexation will then be able to identify that the second stem is semantically the head of the compound, and both stems have only a single referent. However, the co-indexed elements cannot be predicted for

the same entity, so the operation will only create the meaning of association (i.e., ‘hair that is somehow associated with dog’). The ultimate interpretation is subject to how the speaker interprets it, as shown between the curly brackets below:

(16)	Skeleton	[+material ([i])]	[+material ([i])]
		dog	hair
	Body	<natural>	<natural>
		<animate>	<inanimate>
		<canine>	<thread-like>
		{ <i>hair of the dog,</i> <i>hair in the shape</i> <i>of a dog, etc.</i> }	

The compound [dog’s hair] does exist, although it is less common than [dog hair] (Roesnbach, 2006, p. 89). Lexicalization might play a role in the loss of the inflection, but for those who include the possessive inflection in the process of co-indexation are probably motivated by the feature of animacy and also to further restrict the meaning to ‘a type of hair’. First, the lexical item *dog* is subject to affixation with the possessive suffix ‘s at stratum 2. At the same stratum, *dog’s* undergoes the operation of co-indexation with the lexical item *hair*:

(17)	Skeleton	[+material ([i])]	[+material ([i])]
		dog’s	hair
	Body	<natural>	<natural>
		<animate>	<inanimate>
		<canine>	<thread-like>
		{ <i>hair of the dog</i> }	

The inflected form *dog’s* has lost its referentiality and become type-restricted.

b. [*student nurse*] vs. *[*student's nurse*]: The semantic feature of the skeletons and the bodies of both elements are the same (i.e., both are natural, and human, and the skeletons are identical, [+material] and [+dynamic]), which means that the co-indexed elements will be predicted of the same entity ('student who is nurse').

(18) Skeleton	[+material, dynamic ([i])]	[+material, dynamic ([i])]
	student	nurse
Body	<natural>	<natural>
	<human>	<human>

The compound is not open for variation; for example, the possessive inflection cannot be used to get the same meaning because it will change the relationship between the elements: *Student's nurse* will refer to 'a nurse for students'.

In sum, possessive compounds align with noun-noun compounds, except in the criterion of animacy. Although a number of factors affect the use of the possessive inflection, animacy is still crucial. Table 2 summarises the features of the three alternatives: prenominal possessives, possessive compounds and non-possessive compounds (Taylor, 1996, p. 313):

Table 2: Some characteristics of prenominal possessives, possessive compounds, and non-possessive compounds

Prenominal possessives	Possessive compounds	Non-possessive compounds
Referential – usually definite (i.e., ‘instance specialisation’)	Non-referential (i.e., ‘type specification’)	Non-referential (i.e., ‘type specification’)
Possessor nominal referential (topical and usually definite)	Possessor non-referential or weakly referential	Modifier nominal non-referential
Possessor nominal, often human or animate	Possessor nominal, almost always human or animate	Modifier nominal, typically non-human
Possessor and possessee can be pre- and post-modified	Little possibility of modification of head noun or modifier	Little possibility of modification of head noun or modifier
Variable interpretation	Conventionalised interpretation	Conventionalised interpretation
Final stress	Initial stress	Initial stress
Written with word space and apostrophe	Written with word space and apostrophe	With lexicalisation, apostrophe and word space may be omitted

In many cases, compounds containing a regular plural morpheme are clearly distinguished from those containing a possessive (e.g., *paintings collection*, *skills shortages*, *publications catalogue*). However, and as mentioned earlier in this section, for an example like *students union*, the internal morpheme can receive any of the three analyses: N’s N, Ns’ N, or Ns N. Based on the animacy feature, Ns N is excluded. To give a reliable analysis for the appearance of the regular plural inside compounds in (§ 5), compounds with animate modifiers will be avoided.

3. THE MEDIAL S AS A PART OF THE NON-HEAD NOUN

One of the problems encountered in the present research is the confusion between the regular plural and a type of unproductive plurals called 'pluralia tantum in specific sense only' by Johansson (1980, p. 49). The aim of this section is to investigate the types of pluralia tantum and their occurrences inside compounds.

Some nouns in English refer to multiplex objects; these realised as plurals only. They are normally treated like non-count nouns, as they cannot be numerated (e.g. **one clothes*, **two clothes*). This type of inherent plural is described as pluralia tantum, a Latin term that means 'plurals only'. Accordingly, a *pluralia tantum* is supposed to possess two important properties: it should have a fixed plural value and it should not have a morphological singular counterpart that leads its reduction into the singular to be ungrammatical (e.g. **bellow*, **measle*). Huddleston and Pullum (2002, p. 340) referred to this class of nouns as 'plural-only nouns with the s-ending'; they include the following:

(i) *Bipartites*, or *Summation plurals* in Quirk, Greenham, Leech, & Svartvik's (1972) terminology: This class of plurals refers to articles of clothing, tools, or optical aids that consist of two identical parts joined together and having the same function (e.g. article of clothing: *pants*, *shorts*, *pyjamas*, *tights*; tools: *pliers*, *scissors*, *tongs*, *tweezers*, *scales*; optical aids: *binoculars*, *glasses*, *spectacles*, *goggles*) (Huddleston & Pullum, 2002, p. 341). A bipartite noun can be reduced to a singular only if it has a generic meaning

(e.g. *this scissor reportedly never needs sharpening*) (Huddleston & Pullum, 2002, p. 342).

(ii) Plurals denoting substances consisting of particles: This category includes objects made up of particles that have no significance, so the plurality of these particles is what makes the noun plural (e.g. *dregs, oats, grits, Epsom salts*). There are also substances consisting of particles but they are not realised as plural forms (e.g. *rice, salt, sugar*). Huddleston and Pullum (2002) suggested that this is because the particles are very small compared to the particles of substances having the *s*-ending.

(iii) Plurals denoting aggregates of entities: This includes groups of heterogeneous entities or objects (e.g. *arms, goods, refreshments, clothes, groceries, remains, leftovers, dishes, contents*).

(iv) Plurals denoting areas containing a plurality of entities without clear boundaries: (e.g. *bushes, mountains, plains, steppes, woods*). There are also proper nouns that always occur in plural contexts (e.g. *the Alps, the Andes, the Hebrides*).

(v) Other plural-only nouns: Huddleston and Pullum (2002, p. 343) divided this category into 4 sub-categories:

- (19)
- a. Nouns associated with emotions: For example, *apologies, condolences, regards, and remembrances*.
 - b. Nouns suffixed with *-ing* whose bases are verbs: For example, *beginnings, belongings, furnishings, lodgings, savings, and writings*.
 - c. Nouns associated with the concept of compensation and reward for what has been done: For example, *amends, damages, returns, dues, earnings, and wages*.

d. Miscellaneous: For example, *alms, arrears, ashes, brains, customs, odds, heavens, troops, humanities, heads, spirits, looks, holidays, and folks.*

However, Acquaviva (2008) pointed out that the term *pluralia tantum* is just a descriptive label for two phenomena: (i) nouns with s-endings exist but they may trigger singular agreement and (ii) nouns that have singular forms exist but the semantics of the pair differs either slightly or substantially. Each phenomenon will be considered below.

(i) Nouns with s-endings exist but they may trigger singular agreement: Huddleston and Pullum (2002) did not categorise this type of noun under *pluralia tantum*; they called it ‘singular nouns with a plural suffix ending’. Others, like Bergsten (1911), Quirk et al. (1972), Johansson (1980), and Payne (2011), classified them as a type of *pluralia tantum*. With some nouns, it would be difficult to decide whether they trigger singular, plural, or even both singular and plural agreement. For example, a noun like *checkers* occurs in singular contexts, while *cards* may occur in both singular and plural contexts, although both nouns are names of games:

- (20) a. *Checkers* is/ *are a great game.
b. I realize that *cards* are a dreadful waste of your youthful hours.
c. *Cards* is a fantastic way for our family to spend the evening.
(Payne, 2011, p. 119)

The assumption that this difference in the grammatical function might be attributed to the semantics of the individual noun is weak. According to Payne (2011), the noun *cards* would be treated as a plural because *the game of cards* can be individuated and counted while this is impossible for *the game of*

checkers. However, the pluralia tantum *herpes*, although listed in dictionaries as a singular non-count noun, triggers the plural agreement (e.g. *Herpes are caused by the herpes simplex virus (HSV)* (American Heritage Dictionary, as cited in Payne, 2011, p. 120)). This variation would ultimately be attributed to the lexical features of these nouns and the way individuals perceive them.

Regardless of the descriptive label, these nouns are unarguably listed in the lexicon for their idiosyncrasy in form and meaning. They include (i) diseases and ailments (e.g. *bends, hives, mumps, rabies, rickets, measles*); (ii) nouns with singular and plural function (e.g. *barracks, gallows, headquarters, kennels, innings, links, means, mews*); (iii) nouns ending with *-ics* (e.g. *acoustics, economics, ethics, phonetics, politics*); and (iv) games (e.g. *billiards, checkers* (AmE), *draughts* (BrE), *fives, skittles*). Finally, proper nouns such as the names of geographic areas or countries occur in either singular or both singular and plural contexts. It is variable for *Midlands* (e.g. *the Midlands reflects the same picture of poverty and misery* or *the Midlands attract a surprisingly amount of tourists*), while on the other hand, nouns like *the United States* or *the Philippines* almost always trigger singular agreement (Bache & Davidsen-Nielsen, 1997, p. 248)⁷⁹.

⁷⁹ A kind of idiosyncratic plural that might be found inside compounds includes geographic names and country names. Most plural country names are singular in sense, probably because they represent a political unity, while most geographic names occur in plural contexts.

- | | | |
|-----|-------------------------------------|---------------------------------|
| (I) | a. A former United States president | b. The Philippines constitution |
| | c. The British Isles teams | d. The Golan Heights front |
| | e. Highlands and Islands services | f. The Midlands area |

(Johansson, 1980, pp. 13– 15)

(ii) Nouns that have singular forms exist but the semantics of the pair differs either slightly or substantially: Among nouns with an s-ending, some have corresponding s-less forms that have different meanings. The semantic relationship between such pairs is not as transparent as in a pair like *book-books*, because it simply does not reflect the number opposition; rather, it reflects a special meaning through the s-ending. Such s-forms are listed in the dictionary with their specific sense of semantic relatedness; the singular form varies from a noticeable dissociation (e.g. *look – looks; brain – brains*) (i.e. homonyms) to somehow a related meaning (e.g. *admission – admissions*) (i.e. polysemes). For the latter example, there is insufficient evidence to argue that pairs with related meaning originate from different lexical items (Corbett, 2000, p. 176; Acquaviva, 2008, p. 17). Other examples of such plurals are illustrated in (21):

(21) a. amends, arms, ashes, banns, looks, clothes, the commons, customs, dregs, funds, goods, heads, holidays, letters, lodgings, manners.
(Quirk et al., 1972, pp. 169-170)

b. bearings, brains, crops, depths, dimensions, directions, foundations, gates, heavens, heights, intricacies, mists, plans, preparations, proofs, resources, results, skies, snows, suspicions, thoughts, times, views, waters, winds.

(Acquaviva, 2008, p. 18)

Quirk et al. (1972) used the term *pluralia tantum* to refer to such nouns, while Johansson (1980, p. 49) more precisely used the term ‘*pluralia tantum in specific sense only*’. This kind of plural is important when discussing plurals inside compounds, because it overlaps regular plurals.

3.1 Pluralia Tantum and Compounding

In the theories of lexical stratification, pluralia tantum are formed at stratum 1 whether they are affix- or base-driven (e.g. Kiparsky, 1982, and Giegerich, 1999, respectively), hence allowing their involvement in compounding at stratum 2. Such nouns in the general situation retain their forms inside compounds, and their reduction into singulars leads to ungrammaticality:

- | | | |
|------|--------------------------|----------------------|
| (22) | a. almsgiving | *almsgiving |
| | b. oddsmaker | *oddmaker |
| | c. painstaking | *paintaking |
| | d. humanities department | *humanity department |
| | e. clothesbrush | *clothebrush |
| | f. arms race | *arm race |

(Kiparsky, 1982, p. 9)

Nevertheless, there are perfect compounds whose pluralia tantum in the non-head position are reduced to singulars (e.g. *scissor legs*, *trouser pocket*). Johansson (1980) observed that the invariability of the s-forms is very high in frequency. An early discussion of this phenomenon is found in Bergsten (1911) in his chapter *Plural Compounds*. He argued that the preservation of s-forms depends on grammatical function and semantics. In cases with the singular function or those that are apprehended as singulars, the s-form is almost always retained:

- (23) Pluralia tantum with often or always singular function:
- a. Bellows: bellows-mender
 - b. Gallows: gallows rope
 - c. News: news-carrier
 - d. Barracks: barracks-room, barracks bag, barracks lawyer vs. barrack square (very rare)

- e. Billiards: billiards ball, billiards champion, billiards table(s), billiards player(s) vs. billiard hall, billiard table (very rare)
- f. Craps: craps table, craps dealer
- g. Darts: darts game, darts league, darts league, darts-player
(a-c from Bergesten, 1911, pp. 76-80;
d-g from Johansson, 1980, p. 17-24)

For pluralia tantum with both singular and plural functions, variation may arise as in (24a):

- (24) Pluralia tantum with both singular and plural functions:
- a. Headquarters: headquarters company, headquarters team vs. headquarter camp
 - b. Means: means-test, means-testing
(Johansson, 1980, pp. 28 & 31)

For nouns with a plural function only, the s-form is kept where necessary; they have no singular forms, and they do not exhibit special meaning, so s-less forms do not affect the meaning of the lexical item.

- (25) Pluralia tantum with plural function
- a. Archives (usually in plural): archives classification vs. archive studies
 - b. Breeches: working breeches-maker
 - c. Earnings: earnings decline, earnings figures vs. earning potential
 - d. Munitions: munitions factory, munitions work vs. munition factories ⁸⁰
 - e. Odds: Odds-maker
(Johansson, 1980, pp. 19, 21, 25, 32, & 33)

Finally, in the case of pluralia tantum in specific sense only, since they have corresponding singular forms but their meaning in the plural form is different, the retention of the s-form is necessary in most of the cases to avoid ambiguity. In the examples below, the special meaning of the plural form is

⁸⁰ In the Oxford English Dictionary (OED online, 2013), the lexical item is listed as a modifier in its singular form.

indicated, quoted from either the Oxford or Cambridge English dictionary online (2013)⁸¹, accompanied by examples of compounds with these plurals versus compounds (except those indicated in brackets) containing s-less forms with the standard meaning.

(26) Pluralia tantum in specific sense only

	Special meaning in plural	Examples
a. admission	the people allowed into a college, hospital, or other place, or the process of allowing people in (CED)	<i>admissions officer vs. admission fees</i>
b. activity	something that is done for enjoyment, especially an organized event (CED)	<i>activities organiser, activity time</i>
c. art	subjects of study primarily concerned with human creativity and social life, such as languages, literature and history (as contrasted with scientific or technical subjects) (OED)	<i>Arts course, arts student vs. art editor, art student</i>
d. communication	(i) means of sending or receiving information, such as telephone lines or computers; (ii) means of travelling or of transporting goods, such as roads or railways (OED)	<i>communications network vs. communication skills</i>
d. customs	the place at a port, airport or border where	<i>Customs department, customs duties, customs regulations⁸² vs. custom design</i>

⁸¹ The source is identified as either OED for Oxford English Dictionary or CED for Cambridge English Dictionary.

⁸² *Custom-house*, which has the meaning of *customs*, does also exist. Bergsten (1911, p. 93) claimed that *custom-house* existed before *customs* was coined. He also claimed that the noun acquired the s-ending by 'the irresistible agency of analogy'.

	travellers' bags are looked at to determine whether any goods are being carried illegally (CED)	
e. futures	agreements for the buying and selling of goods, in which the price is agreed before a particular future time at which the goods will be provided (CED)	<i>futures traders, futures market vs. future loss (NP)</i> ⁸³
f. humanity	the study of subjects such as literature, language, history and philosophy (CED)	<i>humanities department vs. humanity's demand (possessive compound)</i>
g. honour	something regarded as a rare opportunity and bringing pride and pleasure; a privilege: (i) a special distinction for proficiency in an examination; or (ii) a course of degree studies more specialized than for an ordinary pass (OED)	<i>honours degree vs. honour killing</i>
h. moral	standards of behaviour; principles of right and wrong (OED)	<i>morals police, morals violation vs. moral education (NP)</i>

(Corpus of Contemporary American English, 425 million words, 1990–2011)

What makes many pluralia tantum in specific sense only problematic for use studying the occurrence of regular plurals inside compounds is the

⁸³ The lexical item is related to money: The corresponding singular form *future* is completely disassociated in meaning. The adjectival phrases *future traders* and *future market* are semantically distinguished from their corresponding compounds with pluralised non-heads.

existence of transparent pairs that reflect number opposition alongside these nouns, as illustrated in (27):

- (27) a. activity (i) many activities
(ii) activities: an activity or sport in which people compete with each other according to agreed rules.

In (27) we have two plurals: one reflects the number opposition to its singular form without changing meaning, while the other conveys a meaning different from its corresponding singular form. In some compounds that have a noun like *activities*, it can be confusing to decide whether a *plurale tantum* or an ordinary plural has been used, especially when both plurals are related to one concept. For example, *activities centre* can be coherent with both plurals as a centre in which different types of activities can be enjoyed. According to this meaning, *activity centre* is also used and preferred. On the other hand, it can refer to a centre in which organised events take place and people compete under specific rules. Which is the correct intended meaning can only be determined from the context. The head noun in some compounds may contribute to resolving ambiguity; for example, *activities* in its specific sense is understood in a compound like *activities committee*, which gives the sense of an organised event, while the ordinary plural is understood in a compound like *activities book* (although *activity book* is much preferred):

- (28) 'An activities book was developed that mentors used to guide children as they learn about self-esteem, problem-solving skills, refusal skills, communication skills, and the like.'

(Hurley & Lustbader, 1997, p. 523)

Consider also the different meanings of the lexeme *ADMISSION*: (i) Standard meaning: '(C or U) the money you pay to enter a place' (CED online). For example:

(29) 'There is an admission charge and additional revenues from the sale of food and beverages'.

(Kaplan, 1993, p. 122)

(ii) Special meaning in plural: 'The people allowed into a college, hospital, or other place, or the process of allowing people in' (CED online).

For example:

(30) 'Any admissions policy must put some applicants at a disadvantage, and a policy of preference for minority applicants can reasonably be supposed to benefit the community as a whole....'

(Sweatt, 1977, p. 69)

As indicated above, the head might affect the use of the s-form. The s-less form of the *plurale tantum*, *admissions*, might be found inside the compound. When we say *admission policy* or *admission office*, for example, it seems that the semantics of the heads are sufficient to infer the special meaning of the left-constituent.

(31) 'The admission office observed the applicants' test scores and their group identities....'

(Heffetz & Frank, 2011, p. 180)⁸⁴

Moreover, there are compounds whose *plurale tantum* with its specific sense is easily distinguished from the meaning of the corresponding singular-plural pair, when the meaning is so disassociated that they are treated as homonyms:

⁸⁴ Examples from (24) to (27) are extracted from Google Book Corpus.

- (32) a. custom (i) customs (tradition); e.g. *custom design*
(ii) customs (official check); e.g. *customs officer*

Similarly, *arts, arms, humanities*, and *honours* are intuitively dissociated from their s-less forms, and the inclusion of the plural morpheme is necessary to avoid ambiguity. For example, *arts student* is different from *art student*, *humanities department* vs. *humanity's demand*, etc. It should be noted here that when investigating the occurrence of regular plurals inside compounds, s-forms with potential *plurale tantum* meaning should be avoided.

4. PRE-MODIFIED REGULAR PLURALS INSIDE COMPOUNDS

A number of compounds exist whose non-head position is occupied by phrases that might not necessarily be lexicalised, institutionalised or have quotation status; *historic buildings* is a phrase that can be embedded in compounds, e.g. *historic buildings inspector*. Note that in such constructions the regular plural can show up as an internal inflection without any problem. A compound like **rats eater* is ill-formed, but adding the adjective does seem to work, as in *red rats eater*, which sounds fine (Alegre & Gordon, 1996, p. 66). Alegre and Gordon (1996) provided evidence that children's minds allow for a syntactic unit to appear within a morphological unit. In their experiment, children preferred a picture of *red rats* over a picture of *red eater* when asked about *red rats eater*, but, on the other hand, they preferred a picture of *red eater* when asked about the *red rat eater*. It is interesting that the plurality of

the phrase triggers the interpretation of a phrase embedded in the compound. Similarly, in an example like *new books shelf*, the internal inflection helps to interpret the construction as a compound having an embedded phrase, *a shelf for new books*, but the absence of the plurality would make the interpretation ambiguous, i.e. *a new shelf for books* or *a shelf for new books*. To provide a more reliable interpretation of the phenomenon in question, this kind of construction should be avoided when studying compounds with a plural on the non-head used in contexts taken from the Google Books Corpus.

5. SEMANTIC FUNCTION OF THE REGULAR PLURAL INSIDE COMPOUNDS

The aim of this section is to demonstrate that the regular plural cannot be related to the linking element, despite Lieber and Štekauer's (2009) claims, because it has a semantic function.

Sproat (1985) argued that the regular plural shows up inside compounds to denote a collective meaning. Senghas, Kim, and Pinker (2007, p. 17) similarly pointed out that 'a compound may contain a plural if the referent of the head interacts with the multiple referents of the non-head in some way that is specific to the entire collection of them'. For example, *parks department* refers to a department of some specific sorts of parks, not only old parks; *systems analyst* refers to an analyst of specific sorts of systems such as *computer systems* or *economic systems* (Sproat, 1985, p. 415).

Sproat (1985, p. 420) made the following generalisation: '[T]he left member of a compound must be left unmarked for number, unless the plural is interpreted collectively or idiosyncratically'. The account of collectivity is similar to the heterogeneous semantics suggested by Alegre and Gordon (1999); if the meaning of the non-head noun referred to different kinds rather than individuals, then it could license the plural. So, *a publications catalogue* probably refers to a catalogue of publications of different genres, not just one type of genre with many publications. Similarly, *counterexamples list* would refer to a list of different sorts of counterexamples, not only one type with many exemplars. In this sense, collectivity and heterogeneity have a similar meaning, in that they create the assumption that the collection contains many different kinds.

I contribute to this argument by arguing that, although heterogeneity is a very important factor for motivating the appearance of the regular plural, it overlaps other factors, all of which are related to the phenomenon of polysemy.

5.1 Polysemy

Most words in any language carry more than one meaning, creating a problem in semantic interpretation known as lexical ambiguity, which is divided into two types depending on how the multiple meanings are related: contrastive ambiguity and complementary ambiguity (Pustejovsky &

Boguraev, 1996)⁸⁵. Contrastive ambiguity is also known as homonymy and refers to two linguistic forms that are identical in orthography and phonology, but have disassociated meanings:

- (33) a. The *bank* of the river
b. The richest *bank* in the city

- (34) a. Drop me a *line* when you are in Boston.
b. We built a fence along the property *line*.
a. The judge asked the defendant to approach the *bar*.
b. The defendant was in the pub at the *bar*.

(Pustejovsky & Boguraev, 1996, p. 2)

In some cases, ambiguity is easily resolved since the distribution of these words depends on the context in which they occur, as illustrated in (33) & (34) above.

Complementary ambiguity (traditionally known as polysemy) is, on the other hand, of direct importance to account for the semantic function of the regular plural inside compounds. Polysemy is derived from the Greek *poly-* + *sem*, meaning literally ‘many’ + ‘sense’ (Cuyckens & Zawada, 1997, § Introduction) and is defined as ‘the property of a single word having distinguishable but related subsenses’ (Kearns, 2006, p. 568)⁸⁶. For example,

⁸⁵ Lexical ambiguity also arises from other factors: homophony, lexemes with identical phonology but different orthography (e.g. *knight* vs. *night*) and homography, and lexemes with identical orthography but different phonology (Glover, 2005, p. 11).

⁸⁶ Another criterion of distinguishing between polysemy and homonymy is the origin of the word (or ‘etymology’). It has been taken as a condition of homonymous words that they should be historically derived from different sources (Lyons, 1977, p. 550). For example, *bank* ‘raised earth’ and *bank* ‘financial institution’ are two homonyms by virtue of their different historic origins; the former derived from the Old Danish *banke*, while the latter derived from the Italian word *banca*, meaning ‘a money-changer’s table’ (Glover, 2005, p. 10). Etymology has been criticised since native speakers are often unaware of the history of words they are using, and also the origin of words is not always straightforward; one example taken from Lyons (1977, p. 551) is *port*₁ ‘the harbour’ and *port*₂ ‘wine from Portugal’;

school has different but related senses, such as ‘the building’ (e.g. *the roof of the school needs to be painted*) and ‘the institution’ (e.g. *Brooklyn School is a good school*), ‘teachers and students’ (e.g. *the school is mourning the untimely passing of the English teacher*) (Cuyckens & Zawada, 1997, § Introduction). In contrast, a word with only one meaning is called a ‘monosemy’. The notion of polysemy is also extended to include senses belonging to different syntactic categories as far as there is association between their meanings. For example, the verb sense of *school* is still associated with the concept of learning:

- (35) a. He *schooled* himself in the art of public speaking.
 b. She *schooled* her horse for show-jumping.
 (Zawada, 2007, p. 151)

There are instances of meaning alternatives discussed in the literature that are considered systematic in the sense of a word whose semantic alternations follow a general pattern; for example, *chicken* is systematically used to refer to animal and meat, and this practise can be extended to involve words like *turkey*; *newspaper* is systematically used as an institution, physical object, or content which can be extended to other words such as *magazine*; *book* can be used as either a physical object or content, and also applies to words like *letter*, *novel*, *magazine*, and *CD* (Pethő, 2007)⁸⁷. Systematic

*port*₁ is of Latin origin ‘portus’, while *port*₂ is a recent word derived from the city of Portugal where a specific kind of wine is made. However, Portugal *Oporto* itself was derived from the Latin word *o porto*, which had the sense of ‘the harbour’, and the Portuguese word *porto* originates from the same Latin lexeme from which the English *port*₁ derives.

⁸⁷ Irregular polysemy, on the other hand, typically characterises metaphoric polysemy. In fact, throughout the literature, there are many and different subdivisions of polysemy, including metaphoric polysemy and metonymic polysemy. Metaphoric polysemy refers to a lexical item that has figurative and literal senses and in which the former is derived from the

polysemy has also been referred to as ‘regular polysemy’ (Apresjan, 1974) or ‘logical polysemy’ (Pustejovsky & Boguraev, 1996). In (31), a list of possible systematic conversions between the senses of words is provided, including *window*, *newspaper*, *chicken*, *book*, *radio*, *France*, *game*, and *vanity*. These occur in different contexts where the alternative senses are manifestations of the same core meaning and, in many cases, pragmatics and context reveal the specific sense:

- (36)
- a. The *window* was broken. (= 'window glass')
 - b. The *window* was boarded up. (= 'window opening')
- a. The *newspaper* weighs five pounds. (= 'publication')
 - b. The *newspaper* fired John. (= 'publisher')
- a. The *chicken* pecked the ground. (= 'bird')
 - b. We ate *chicken* in bean sauce. (= 'meat')
- a. The *chair* was broken. (= 'chair token')
 - b. The *chair* was common in nineteenth-century parlours. (= 'chair type')
- a. The *book* weighed five pounds. (= 'book copy')
 - b. The *book* has been refuted. (= 'book content')
- a. We got the news by *radio*. (= 'medium')
 - b. The *radio* is broken. (= 'radio set')
- a. *France* is a republic. (= 'nation')

latter by analogy. For example, *mouse* has two senses—the literal ‘small rodent’ and the metaphoric ‘computer device’—in which the computer device has similarity with the small rodent (Apresjan, 1974, p. 7). Whether some lexical items with both metaphoric and literal senses can be considered polysemous remains a controversial topic. For example, *bright* is used metaphorically (e.g. *Tom is very bright and hardworking*) as well as literally (e.g. *This house is very bright*); such a lexical item might be perceived as one linguistic form having two related meanings to some speakers (i.e. polysemous), but as two linguistic forms to other speakers (i.e. homonymous). For metonymic polysemy, it refers to a word or phrase substituted for another to denote a concept or object, both of which are closely related (e.g. the ham sandwich is sitting at table 20) to refer to a customer in a restaurant context (Nunberg, 1978, p. 22). Systematic polysemy has an affinity with metonymic polysemy, but I will use the former term throughout this chapter.

- b. *France* has a varied topography. (= 'region')
 - a. The *game* is hard to learn. (= 'rules')
 - b. The *game* lasted an hour. (= 'activity')
 - a. *Vanity* is a vice. (= 'the quality of being vain')
 - b. His *vanity* surprised my friends. (= 'the extent of his vanity')
- (Nunberg, 1979, p. 148)

Among various types of systematic sense alternations discussed throughout the literature, three types of sense alternations can be related to the use of the regular plural within compounds: token/type, mass/count, and object/text alternation. In the following sub-sections, I define each category and discuss its contribution to the appearance of the regular plural inside compound. Another kind of polysemy involved is related to the syntactic category of the left constituent, in that the regular plural appears to distinguish nouns from adjectives. The discussion will include analysis of a number of compounds within texts extracted from Google Books British and American Corpora⁸⁸.

5.1.1 Categories of polysemy and regular pluralisation within compounds

5.1.1.1 Type/ token polysemy

In type/ token polysemy, a lexical item may refer to a type of entity or to an individual member of that type (tokens):

⁸⁸ [http:// googlebooks.byu.edu/](http://googlebooks.byu.edu/)

- (37) a. The *terrorist* carried the bomb. (token)
 b. The *terrorist* is our nation's enemy. (type)
 (Glover, 2005, p. 12)
- (38) a. The *chair* was broken. (= 'token')
 b. The *chair* was common in nineteenth-century parlours. (= 'type')
 (Nunberg, 1979, p. 148)

When such nouns occur in the non-head position, this ambiguity is resolved; they refer to types rather than tokens. For example, *car manufacturer* does not refer to a manufacturer of only one car. However, when nouns are pluralised within compounds, they are divided into acceptable compounds or questionable compounds.

- i. With acceptable compounds, the pluralisation reveals the meaning of 'several types of'; for example, *enemies list, cereals production, paintings collection, etc.* The ambiguity here is more related to whether the left constituent refers to one type or to various types.
- ii. With questionable or unacceptable compounds, pluralisation substitutes the generic interpretation with the meaning of 'many tokens': *claws marks, watchesmaker, cars manufacturers, etc.*

i. Enemies list vs. enemy list

For the case of enemies list vs. enemy list, two possibilities can be highlighted justifying the existence of the suffix -s: (i) it is a possessive compound and the non-head *enemies* is a plural noun whose feature of animacy also motivates the use of the possessive inflection and (ii) it is a nominal compound with a pluralised non-head. Regardless of the type of

compound, the regular plural is present. The possible objection to the semantic value of the internal regular plural is associated with the use of the head *list*⁸⁹; there is no need to pluralise the non-head because it would not have been a list if it had not contained more than one enemy. However, when we compare *enemy list* with *enemies list*, a sort of ambiguity is associated with *enemy list*. Two senses may be associated: (i) the compound may refer to one type of enemies with many individuals or (ii) the compound may refer to various types of enemies. For *enemies list*, on the other hand, the second sense is felt. As illustrated in the following quotation, *enemies list* refers to a list of different types of enemies:

(39) ‘The enemies list was a term given to a plan in the Richard Nixon administration to discredit and punish people considered to be political enemies of the president...included politicians, federal bureaucrats, business leaders, academics, labor leaders, journalists, and individuals who had very little connection to politics.’

(Oslo, 1999, p. 142)

Enemy list is also found in the corpus. This can also carry the same meaning as *enemies list*, but in the quotation below, it refers to a number of enemies who are related to media:

(40) ‘The enemy list contained a total of fifty-six reporters, editors, columnists, and television commentators’.

(Bollinger, 1994, p. 195)

⁸⁹ See, for example, Lieber and Štekauer’s (2009, p. 13) comment on the compound *programmes list*.

ii. Appliances industry vs. appliance industry

The regular plural inside *appliances industry* gives the sense of variety.

However, compare the three compounds in the following extract:

(41) 'In a little more than a decade, Honda conquered the motorcycle market, first in the USA, then in the rest of the world. Sony did the same in the appliances industry, Toyota in the car industry....'

(Garcia & Lucas, 2012, p. 244)

Motorcycle market, *appliances industry*, and *car industry* all refer to industries or markets of heterogeneous types of products. The sense of heterogeneity of *appliances industry* and *car industry* is spelled out in the following quotation.

(42) 'Differentiated oligopoly, on the other hand, exists in industries where products are not homogeneous...The car industry and the appliance industry are examples of differentiated oligopoly. Consumers can choose from several car models, different stereos, refrigerator brands.'

(Pagoso, Dinio, & Villasis, 2008, p. 214)

Note that in (42), the regular plural does not appear inside *appliance industry*, demonstrating that it is optional, or in other words the sense of heterogeneity can be conveyed by the s-less nouns. However, its pluralisation emphasises the sense of vast types of machines and devices of different shapes, sizes, and uses. The important question here is why **cars industry* is ill-formed despite the fact that it is defined as an industry of heterogeneous cars. Here, I suggest that when we say or hear the plural noun *cars*, whatever their type, model, or size, the only thing that may come to mind is an image of a vehicle with an engine and wheels, so pluralising it within compounds motivates the sense of tokens rather than types. Compare,

for example, *vehicle* with *car*. *Vehicle* has a wider sense than *car* because it includes all the things used for transportation, and it even includes children's toy vehicles and space and missiles vehicles, etc.; pluralising *vehicle* within compounds gives the sense of 'many types' rather than 'instances of one type':

(43) 'But to market, consumers and ordinary people who focus on the vehicles industry will be confused. They don't have a fresh intuitive impression in it.'

(Lee, 2011, p. 144)

(iii) Weapons inspector vs. weapon inspector

In the following extract, the non-head of the compound refers to inspectors who are specialised in mass-destruction weapons. The pluralisation gives the sense that these weapons include many types (e.g. chemical, biological, radiological, nuclear, etc).

(44) 'Former U.N. weapons inspector Scott Ritter gave a different picture of the weapons issue, contending that 90 to 95 percent of Iraq's weapons of mass destruction were destroyed in the 1990s.'

(Dorrien, 2010, p. 226)

A weapon inspector does also exist:

(45) 'After the Gulf War he worked in Iraq as a weapon inspector between 1991 and 1998....'

(Arslan, 2005, p. 107)

The compound in (45) is ambiguous; it is not clear whether it refers to an inspector who is specialised in different types of weapons or who specializes in just one type with many instances (e.g. a biological weapon

inspector is specialised in weapons with biological agents such as viral, bacterial, fungal, etc.).

(46) 'Charles Duelfer, a fellow former biological weapon inspector, stated in testimony before the Senate Armed Services Committee that the biggest challenge confronting Iraqi biological and chemical weapons prospects is advances in warheads....'

(U.S.G.P.O., 2002, p. 61)

iv. Drinks dispenser vs. drink dispenser vs. drinks cabinet

Drink dispenser is ambiguous; it may refer to a dispenser of selections of one type of drinks (as in Picture 1) or a dispenser of a variety of drinks such as the one in Picture 2. However, this ambiguity is resolved by use of the regular plural inside *drinks dispenser*, which stresses the meaning of variety.



Picture 1: Drink dispensers⁹⁰



Picture 2: A drinks dispenser⁹¹

⁹⁰ Taken from <http://givegoodgift.ca/%20glass-drink-dispenser/>

⁹¹ Taken from <http://www.molon.de/galleries/Japan/Tokyo/RailwayStation/img.php?pic=10>

**Cups dispenser*, on the other hand, sounds strange because it promotes the sense of ‘many tokens’, and it seems unlikely that a dispenser of different types of cups exists.

With regard to *drinks cabinet*, in all of the texts examined it refers to alcoholic drinks:

(47) ‘Larry staggered into the living room to find the spare bottle of whisky he always kept in the drinks cabinet. He had sobered up surprisingly quickly and wanted another drink to help him think’.

(Vincent, 2006, p. 182)

A singular form was also found with the same meaning, albeit rare (only 89 occurrences in comparison with 829 occurrences of *drinks cabinet* were found on Google American Books Corpus)⁹²:

(48) ‘Ramsey stood up, went over to the drink cabinet on the sideboard, and poured whiskey into his glass’.

(Colin, 2012, p. 386)

The association between *drink/ drinks* and *cabinet* gives the whole form a specific meaning, but yet the meaning of variety is still sensed with *drinks*.

v. Antique shop vs. antiques shop

In line with previous analyses, *Antique shop* is ambiguous between two senses: it could hold one type or many types of antiques and, by pluralising the non-head, the form will be restricted to reference a shop of different types

⁹² It is interesting that the number of occurrences of the form *drink cabinet* in the corpus of Google British books is zero, so it seems that American and British English vary in terms of use of the regular plural inside compounds.

of antiques, as in the following quotation where it refers to two types of furniture:

(49) 'John Drum has owned his own antiques shop specializing in seventeenth- and eighteenth-century decorative furniture'.

(Eberts & Gisler, 2006, p. 154)

Interestingly, *antiques shop* in the preceding quotation was in fact *antique shop* in an older edition of the same book:

(50) 'John Drum has owned his own antique shop specializing in seventeenth- and eighteenth-century decorative furniture'.

(Eberts, 1992, p. 138)

The regular plural inside *antiques shop* is optional, but its presence gives a more focused meaning of variety.

5.1.1.1.1 'One type/ many types' ambiguity and other overlapping factors

The discussion on the ambiguity between 'one types', and 'many types' raises the question of why the regular plural motivates the meaning of 'many types' in some compounds (such as *appliances industry*, *weapons inspector*, *drinks dispenser*, and *antiques shop*,) while it motivates the meaning of 'many tokens' in others (such as **cars industry*, **motorcycles industry*, and **cups dispenser*). This suggests that there might be other factors that are related to the semantic nature of the lexical items that happen to occur in the non-head position.

First, in the case of *drinks dispenser*, it is observed that *drink* is polysemous between count and mass senses, while for *cups dispenser*, the lexical item *cup* is always countable and this raises the possibility that this kind of polysemy has something to do with plurality inside compounds. That is, the regular plural does not only prove variety but also countability. However, in the case of *appliances industry*, *appliance* is always countable. It accepts the regular plural, but it is also observed in the corpus of Google books that the vast majority of *appliances industry* was with a pre-modification (e.g. *domestic appliances industry*, *electrical appliances industry*). It was explained earlier (§ 4) that these forms represent a type called ‘phrasal compound’, and the appearance of the regular plural is unproblematic.

Weapons is also always countable. However, *weapons inspector* is listed in some dictionaries as ‘a scientist who is sent to a country that has or that might have biological or nuclear weapons in order to check that UN resolutions (=laws) on these types of weapon are being obeyed’ (Longman English dictionary, online, 2013). As a listed form, this would question the status of the regular plural inside compound as a real suffix.

Second, for *antiques shop*, it is observed that *antique* is polysemous with regard to its syntactic category as a noun or adjective, and this suggests another function of the regular plural inside compounds. That is, the regular plural resolves the syntactic category of the left constituent. Interestingly, it also affects its interpretation because it motivates the meaning of ‘many

types'. For example, in *antiques shop*, the regular plural stresses that the left constituent is a noun that also has variety.

These two observations will be further investigated. They suggest that the sense of 'many types' is more motivated if the left constituent as a lexeme is polysemous with regard to count and mass senses, adjective, and noun categories. Another kind of polysemy will also be discussed – text/ object polysemy.

5.1.1.2 Mass/ count polysemy⁹³

Nouns in English can be classified as countable or mass. A singular noun that occurs in the countable context refers to one individual entity. A plural noun that occurs in the countable context refers to a number of individuated entities. Meanwhile, mass nouns refer to substances or concepts that cannot be individuated (Schwartz, 2002). This classification is strict for some nouns in the sense that countable nouns cannot be used in non-countable contexts and vice versa:

- (51) a. There was water all over the floor.
b. There was a book all over the floor⁹⁴.
(Corbett, 2000, p. 79)

⁹³ I am greatly indebted to my supervisor, Heinz Giegerich, who drew my attention to the issue of countability.

⁹⁴ We also have bare plurals that behave like mass nouns (e.g. *there were books all over the floor* (Corbett, 2000, p. 79)), and, according to Acquaviva (2008), this kind of plural is subcategorised under the term *pluralia tantum* (see Corbett, 2000, pp. 79–80 for a discussion on the distinction between mass nouns and bare plurals).

However, other nouns can be compatible with both categories. For example, count nouns can act as mass nouns and mass nouns can act as count nouns. The examples in (52) illustrate that some nouns have both count and mass senses:

- (52) a. The house is built of *brick*.
b. He used *bricks* to build his house.
- a. I want an evening *paper*.
b. Wrap the parcel up in brown *paper*.
- (Quirk et al., 1985, pp. 246-247)

The semantic shift from mass to count and vice versa is called 'reclassification' (Quirk et al., 1985), which is predictable; thus, in many cases it is unnecessary for these terms to be listed in the dictionary. Huddleston and Pullum (2002) suggested that such nouns represent a phenomenon called 'polysemy' rather than homonymy. Falkum (2010) illustrated how systematic polysemy rests on count/ mass distinction in the following example:

- (53) *Rabbit* has three possible sense alternations.
- a. A *rabbit* jumped over the fence. (animal-count)
b. We're having *rabbit* for dinner. (meat-mass)
c. The model wore *rabbit* on the catwalk. (fur or 'animal stuff'-mass)
- (54) *Pine* has two possible sense alternations.
- a. We have a *pine* in our garden. (tree-count)
b. This table is made of *pine*. (wood-mass)
- (55) *Cherry* has four possible sense alternations.
- a. Susan decorated the cake with a *cherry*. (fruit-count)
b. When the kids left, there was *cherry* all over the kitchen floor. (fruit stuff-mass)
c. Jill and Joan have a *cherry* in their garden. (tree-count)
d. This table is made of *cherry*. (wood-mass)
- (Falkum, 2010, pp. 16-17)

Meanwhile, some senses of mass/ count nouns must be specified, as such pairs are restricted to particular items that can be encapsulated within six types of mass/ count polysemy according to Huddleston and Pullum (2002, pp. 336–337):

Table 3. Types of mass/ count polysemy

Type	Non-count	Count
i. Drink/ food substances (non-count) and servings (count)	I don't like <i>beer</i> .	She offered me another <i>beer</i> .
ii. Foods (non-count) and varieties (count)	We're having <i>cheese</i> for lunch.	These are two of my favourite <i>cheeses</i> .
iii. Animals (count) and food (non-count)	We're having <i>salmon</i> for dinner.	I was lucky enough to catch a <i>salmon</i> today.
iv. Abstract (non-count) and event instantiation (count)	Considerable <i>injustice</i> was revealed during the enquiry.	Two fundamental <i>injustices</i> were revealed during the enquiry.
v. Abstract (non-count) and results (count)	Necessity is the mother of <i>invention</i> .	Edison was honoured for three separate <i>inventions</i> .
vi. Nonce substance interpretations of primarily count nouns	The termite was living on a diet of <i>book</i> .	----

Chierchia (1998) suggested seven features to distinguish between mass and count nouns:

- a. *Availability of plural morphology*
- b. *Distribution of numeral determiners*
- c. *Obligatoriness of classifier and measure phrases for combining with numerals*
- d. *Some determiners occur only with mass nouns*
- e. *Some determiners occur only with plurals and mass nouns*
- f. *Some determiners are unrestricted*

(quoted from Chierchia, 1998, p. 55)

As far as compounds are concerned, the question is how we can distinguish between mass and count nouns if they occur in the non-head position. It was discussed in the previous chapter that such nouns are syntactically isolated; for example, determiners must agree with the head (e.g. **this craft shops*). As the plural morphology is not always prohibited inside compounds, it may be assumed that it can be used as a feature of distinctiveness. In the examples below, the test failed to draw the distinction:

- (56) a. **Informations analysis*
b. **Stamps collection*
c. **Trucks driver*

However, the test is a success with the following examples:

- (57) a. *paintings collection* (count)
b. **paintings workshop* (mass)
- a. *skills shortage*
b. **skills gap*

This raises the question of why the test of plural morphology does not work with compounds in (56). I observed that the lexical items *information*, *truck*, and *stamp* do not represent cases of mass/ count sense alternation; *information* is always a mass noun, while *stamp* and *truck* are always count nouns. There is no ambiguity to resolve. Meanwhile, the pluralisation of *stamp* and *truck* within compounds replaces the generic meaning with a sense of 'many tokens'.

In contrast, the lexical items inside the compounds in (57) are polysemous and they accept the plural morphology as a way of

disambiguation. At the same time, they emphasise the heterogeneous types of *paintings* and *skills*. Example of count/ mass polysemy will be discussed in more detail below.

i. Painting(s) collection vs. Painting workshop

The lexical item *painting* is either count, as in ‘a picture’ (e.g. *the walls are covered in oil paintings* (Cambridge Online Dictionary)) or mass, as in ‘the skill or activity of making a picture’ (Longman Online Dictionary). As a non-head inside compound, the countable sense of *painting* is emphasised through using the plural morphology in a compound like *paintings collection*:

(58) ‘The major paintings collection in Florence with a remarkable range of fifteenth-century works from Tuscany and other regions of Italy’.
(Welch, 2000, p. 351)

However, one would say that the count sense of *painting* inside *collection* is recognisable by the semantics of the head. Three possibilities might be involved here: (i) the regular plural is used to emphasise countability; (ii) the type/ many types ambiguity is the only factor as clarified by the use of ‘range of’ in the quotation above; or (iii) the two factors overlap (i.e. *paintings* is pluralised to emphasise countability, which also facilitates the sense of ‘many types’). The third possibility is supported especially in the case of **pictures collection*; *picture* does not represent a case of count/ mass polysemy, so when pluralised within compounds, the interpretation of ‘tokens’ is forced. A *painting collection* does also exist, meaning that the function of the plural morpheme is for the sake of clarity.

In contrast, *painting* in *painting workshop* has a non-count sense, so it does not accept the plural morphology.

(59) 'Participating in a painting workshop is not just for beginners, and it's not just for professional artists. Anyone can benefit from the experience'.

(MacPherson, 2006, p. 126)

ii. Skill shortage vs. skills shortage

Skill as a mass noun refers both to the ability to do something very well and to a particular ability (as a count noun) (OED online, 2011). *Skill* as a polysemous word in this respect can be pluralised within compounds to stress the countable sense of the non-head:

(60) 'A skills shortage has been categorized as one of the major challenges facing global e-commerce by Bingi and Khamalah (2000)'.

(Lowry & Turner, 2007, p. 354)

The s-less form *skill shortage*, on the other hand, may indicate that the non-head has either a mass or count sense; that is, a shortage of particular skills and also shortage of expertise. Another effect of pluralising *skills* is that it denotes a shortage of many types of skills.

iii. Publication date vs. publications catalogue

Publication has also count/ mass sense alternation; it either denotes the act of making a book, journal, or piece of music available for public sale or denotes the printed forms themselves (e.g. *historic publications* and *religious publications*). The mass sense is probably more evident in compounds such as *publication date* and *publication process*, while the count sense is evident in a

compound like *publications catalogue*. The presence of the plural, however, seems unnecessary in the latter; *catalogue* would be sufficient to understand that the countable sense of *publication* is meant, but it seems that the plural form of such a polysemous noun contributes to the meaning of ‘wide variety’.

This meaning that is described in the following quotation:

(61) ‘Habitat also issues a series of specialized bibliographies on a wide variety of topics related to the housing and human settlements. See the publication catalogue for a listing of these.’

(William, 1998, p. 19)

iv. Building inspector vs. buildings inspector

Building is polysemous; it refers to either a structure such as a house, church, or factory (count sense) or to the process or business of building things (mass sense) (Longman English Dictionary online, 2011). Consider the following example:

- (62) a. It is certainly a fine *building*. (count)
b. There’s plenty of *building* going on. (mass)
(Huddleston & Pullum, 2002, p. 335)

By being pluralised in the following quotation, the countable reading is obvious:

(63) ‘Most small towns have a buildings inspector. Mid-to-large cities have a buildings department within which buildings inspectors work...buildings inspectors also inspect multifamily units and apartment houses’.

(Janik, 2009, pp. 45–46)

The heterogeneous sense of *buildings* is also recognisable by the phrases *multifamily units* and *apartment houses*.

Building inspector is also used extensively, but in this case the lexical ambiguity between mass and count senses still exists unless it is clarified in the context. *Building inspector* may, for instance, refer to an inspector of construction or, more likely, an inspector of the process of building things. In the following quotation, it is very clear that *building* has a mass sense:

- (64) 'Building inspectors are concerned about the building work itself and with the approved plans and compliance with building regulations'.
(Booth & Dyson, 2003, p. 136)

5.1.1.3 Text/ object polysemy (or content/ container polysemy)

Under this kind of polysemy, the sense of an object (or container) is extended to stand for the text (or content) (Pustejovsky, 1995). For example, *book, letter, novel, report, and DVD* as containers can stand for their contents.

Consider the following examples:

- (65) a. I just bought Chomsky's latest book. (container)
b. Chomsky's latest book is awful. (content)
(Blank, 2003, pp. 278-279)
- (66) a. This book is heavy to carry around. (physical object)
b. I read an angry book. (text)
c. This book is great! (text and/ or physical object)
(Bouillon & Viegas, 1994, p. 37)
- (67) a. The DVD was boring. (content)
b. The DVD is scratched. (container)
(Glover, 2005, pp. 12-13)

I will show below how text/ object polysemy and the sense of 'many types' together may contribute to the appearance of the regular plural inside compounds.

i. Book editor vs. books editor

The use of the regular plural within compounds may be affected by the text/ object polysemy of a lexical item. *Book* in both senses are countable, which means that in both senses *book* accepts pluralisation. However, the difference is observed when it occurs in the non-head position of a compound. For example, **I have a books shelf in my house* sounds awkward because it fails to denote the sense of heterogeneity; probably because *books* here have the sense of objects not texts. In contrast, the regular plural inside *books editor* in the following extract has a heterogeneous reading, which might be helped by the text sense of *book*:

(68) 'After a discussion with our then books editor, Paul Akegwur, it was agreed that we needed to mobilise more fully the considerable intellectual power...if the task was needed to be completed'.

(Adefuye, 1993, p. XVI)

ii. Documents examiner vs. document examiner

Document has two sense alternations; it can be a text or an object. In the following extract, it adopts the text sense:

(69) 'To ensure a complete document examination, a document examiner must scrutinize the documents in question before this evidence is tested'.

(Girard, 2011, p. 162)

Use of the regular plural emphasises the interpretation of 'many types of texts', as demonstrated below:

(70) 'As a documents examiner you will be involved in a wide range of cases requiring expertise in all aspects of work in this field from handwriting comparison to ink and paper analysis'.

(Kaye, 1995, p. 265)

In the following, *document* has the object sense:

(71) 'The document database is assumed to consist of 20 million pages. It is assumed that there is very minimal updating of this database, only a few thousand additional pages are added to the data every year'.

(Green, 1993, p. 117)

Documents database was not found in the Google British books, probably because the plural form with an object sense gives the sense of 'many tokens' rather than 'many types'.

As in the case of *books editor*, it seems that the heterogeneous reading of the plural is affected by whether the lexical item denotes a text or an object.

5.1.1.4 Adjective/ noun polysemy

According to Johansson (1980), some pluralia tantum are transformed into adjectives when the plural suffix is stripped off (e.g. *futures, goods, greens, mains, materials, minerals, morals, odds, textiles, singles, solids, pharmaceuticals, receivables, reserves, rights*) and their appearance inside compounds in their plural forms is common, so as to avoid any misinterpretation (e.g. *future market* vs. *futures market*).

For other common nouns, noun/ adjective polysemy⁹⁵ is among the factors that motivate their plural forms within compounds, and again the heterogeneous interpretation of the plural non-head is associated.

⁹⁵ Here, Johansson regards nouns with related meaning but of different syntactic categories as homonyms. As mentioned before, insofar as the lexical items share the same core meanings, they are polysemous regardless of their syntactic categories (Cuyckens & Zawada, 1997).

i. Chemical industry vs. chemicals industry

The lexical item *chemical* can be either an adjective or noun. As an adjective, it means ‘relating to chemicals’:

(72) ‘The chemical industry produces such things as petrochemicals, drugs, and rubber’.

(Cambridge Online Dictionary, 2013)

Use of the regular plural inside *chemicals industry* will prove two things: (i) the non-head is a noun rather than adjective and (ii) the non-head refers to ‘many types of chemicals’:

(73) ‘The chemicals industry – which includes industrial chemicals, pharmaceuticals, pesticides, biocides, food, and feed additives and cosmetics – is one of the world’s largest industrial sectors’.

(OECD, 2010, p. 12)

ii. Explosive production vs. explosives production

The adjectival sense of *explosive*, ‘increasing suddenly’, is evident in the following extract:

(74) ‘Milam (2005) elucidated that reperfusion with delivery of oxygen to cell populations previously exposed to hypoxic conditions can lead to an explosive production of oxygen derived free radicals.’

(Becker, 2011, p. 2015)

The regular plural inside *explosives production* conveys a different meaning, of ‘a substance or a piece of equipment that can cause explosions’ (CED online, 2013)⁹⁶, as is evident in the following extract:

(75) ‘The most critical restraint on explosives production, however, was the supply of nitrates for nitric acid. The Americans decided to emulate the

⁹⁶ The noun *explosive* is listed in its plural form in the Oxford Online Dictionary (2013) as a plurale tantum, which would be an alternative account; however, in other dictionaries like Cambridge and Longman it is listed only in its singular form.

Germans in “fixing” nitrogen from the atmosphere, and constructed two huge installations for the....’

(Stevenson, 2011, p. 261)

iii. Cereal production, cereals production

The lexical item *cereal* is interesting because two kinds of polysemy are involved. One is adjective/ noun polysemy, whereby *cereal* can be used as an adjective, as seen in *cereal bar* (i.e. made of) or to refer to something ‘relating to grain or to the plants that produce’ cereal (Merriam-Webster English dictionary online, 2013), as seen in *cereal farming*. In this case, the regular plural cannot be used inside either *cereal bar* or *cereal farming*.

The other kind of polysemy is mass/ count polysemy. As a count noun, *cereal* is ‘a grain used for food, for example wheat, maize, or rye’; as a mass noun, *cereal* is ‘a breakfast food made from roasted grain, typically eaten with milk: a bowl of cereal’ (OED online, 2013). However, in CED online (2013), *cereal* as a countable noun refers also to ‘a food that is made from grain and eaten with milk, especially in the morning: *breakfast cereals*’. With use of plural morphology in *cereals production*, *cereals market*, *cereals industry*, *cereals sector*, not only countability is emphasized but also the meaning of ‘various kinds of cereals’:

(76) ‘The main producers include Kenya, Malawi, Tanzania, Zambia, and Zimbabwe, countries in which white maize represents two thirds and 90 percent of total cereals production’.

(FAO, 1997, p. 4)

It was also found that *cereal production* and *cereals production* were used in the same text. It demonstrates that the regular plural makes a difference in meaning. In the following quotation, the two variants are used in the same paragraph:

(77) 'The next section discusses some sustainability issues with respect to cereals production. The following section provides an overview of cereal production and trade aimed at getting further insight into the particular structure of cereal markets and trade'.

(Brouwer, 2012, p. 148)

Having examined what the author meant by the two uses, it was found that *cereal production* was used when there is reference to cereal food in general, while *cereals production* was used when there is reference to the production of grains. Nevertheless, *cereal production* with the latter sense is understandable in some other texts, meaning that the regular plural's function as an ambiguity resolver is optional.

6. DISCUSSION AND CONCLUSION

Based on the analysis of compounds in (78), the appearance of the regular plural inside compounds is conditioned on the heterogeneous reading of the regular plural:

(78) Enemies list, enemy list, appliances industry, appliance industry, car industry, weapons inspector, weapon inspector, drinks dispenser, drink dispenser, antiques shop, antique shop, paintings collection, painting collection, painting workshop, skill shortage, skill shortage, publications catalogue, publication catalogue, publication date, buildings inspector, building inspector, books editor, book editor, documents examiner, documents examiner, document database, chemicals industry, chemical industry, explosives production, explosive production, cereals production, cereal production.

For compounds having the plural morpheme on the non-head, there is no ambiguity between the meaning of 'one type' and 'various types'. That is, the meaning is resolved by the regular plural morphology.

However, an important question raised in the discussion was what contributes to that meaning and why the regular plural does not always convey the meaning of 'various types'. A compound like **toys box* is unacceptable because the regular plural affects the generic interpretation of the non-head; *toys* now refers to 'many tokens'.

The analysis of the compounds in (78) revealed that the polysemous nature of the lexical item of the left constituents contributes to the function of the regular plural as an ambiguity resolver. This is summarised at length below:

1. Mass/ count polysemy contributes to the heterogeneous reading of the regular plural inside compounds: **Pictures collection* and *paintings collection* are both countable nouns and share the same head, but the difference is that *painting* is polysemous between mass and count senses. Similarly, **jobs shortage* and *skills shortage* are both countable nouns and share the same head, but the difference is that *skill* is polysemous between mass and count senses. The function of the regular plural is to prove countability that happens to convey the meaning of variety. The latter interpretation is what makes the compound sound acceptable. It should be noted here that not all nouns with this kind of polysemy are involved—probably abstract non-count nouns only.

2. Text/ object polysemy contributes to the heterogeneous reading of the regular plural inside compounds. In *book shelf* and *book editor*, the text sense is clear in the latter, while the object sense is clear in the former. The semantic of the head clarifies this ambiguity. However, *book* with its text sense is ambiguous; whether *book editor* refers to an editor of one text, a type of texts, or many types of texts is unknown. This ambiguity motivates the regular plural to appear to clarify the last sense.

3. Adjective/ noun polysemy is resolved by the regular plural: As clearly illustrated by the comparison of *explosive production* and *explosives production*, both share the same modifiers and the same head. However, the modifier in *explosive production* is ambiguous between the noun and adjective categories, while it is clearly a noun in *explosives production*.

Another point raised during the discussion is whether using the regular plural can be considered optional. All the compounds in (78) can be found without a plural morpheme, making the role of the plural a clarifying rather than a necessary element, and thus optional. The generic interpretation of the non-head would be sufficient, but the stress on the meaning of 'many types' is the main factor.

Optionality would also be attributed to individuals' preferences, as illustrated earlier by the use of *cereals production* and *cereal production* in the same paragraph; the author preferred to use the plural form to clarify that he was referring to *grains* rather than the mass sense of the noun.

The context would be sufficient to understand the intended meaning. For example, the difference between *explosive* as a noun or adjective inside *production* can be easily understood from the context. The head also may have a role in disambiguation; for example, *antique dealer* vs. *antique chair*. The role of the head is obviously absent in a pair of compounds sharing the same head if only one accepts the regular plural, as illustrated in *paintings collection* vs. **pictures collection*, **cars collection*; *skills shortage* vs. **jobs shortage*; *publications catalogue* vs. **houses catalogue*. It is also absent in the case of *antique dealer* and *antiques dealer*; both may denote the same, but use of the plural form gives an emphasis effect on the meaning of ‘various types’.

Last but not least, the analysis certainly has implications on the interaction between the regular plural and compounding at stratum 2 within the model of base-driven stratification. I shall here demonstrate the implementation of the BDS model using Lieber’s operation of co-indexation. It is a tentative account which will be further developed in future research:

(a) *painting collection* vs. *paintings collection*: The semantic feature associated with the skeleton of *painting* is either [+material] to signal its countability or [-material] for its uncountability.

- | | | |
|------|-------------|--------------------|
| (79) | a. painting | [+ material ([])] |
| | b. painting | [- material ([])] |

On stratum 2, (79a) can be co-indexed with the skeleton of *collection*, resulting in *painting collection*. However, with the existence of the form *paintings collection*, I suggest that some speakers use the strategy of

pluralisation (via the rule of affixation in (80)) to stress the countability sense, before it undergoes the operation of co-indexation in (81):

(80) Insert /z/ in env. [painting_]N + plural → paintings

(81)	Skeleton	[+material, -dynamic ([i])]	[+dynamic ([i])]
		paintings	collection
	Body	<artefact>	<process>
		{different types of paintings; plural for imposing the count sense}	

The success of co-indexation is understood from the fact that the plural non-head still keeps the sense of 'type'.

(b) *books editor vs. *books shop*: With these constructions, it appears that the semantic bodies of the first elements play a role in the use of the regular plural; their skeletons are associated with the feature [+material], but the semantic body of the former is associated with the information <text>, while <object> with the latter:

(82)	a. skeleton	[+material ([])]
		book
	body	<text>
	b. skeleton	[+material ([])]
		book
	body	<object>

On stratum 2, (82a) can be co-indexed with the skeleton of the item *editor* to form *book editor*. With the existence of *books editor*, I suggest that the text/object polysemy might motivate some speakers to use the regular plural noun to impose the meaning of 'texts', indicating that the meaning of 'type'

is still preserved, as demonstrated in (83a). Compare this with (83b) in which *books* <object> fails to give the meaning of ‘many types’:

- (83) a. **skeleton** [+material ([i])] [+material ([i])]
 books editor
 <text> <human>
 body {types of books;
 plural for imposing
 the meaning of ‘text’}
- b. **skeleton** [+material ([])] / [+material ([])]
 *books shop
 body <object> <place>

The failure of co-indexation in (83b) can be seen in that *books* keeps the meaning of ‘many tokens’.

In conclusion, the claim that the internal regular plural morpheme should be seen as a linking element because there is no clear purpose for its use (Lieber & Štekauer, 2009) has been thoroughly argued against. The discussion demonstrated that the internal regular plural morpheme has an evident semantic function that restricts its interaction with compounding on stratum 2 of the base-driven stratification model.

CHAPTER IV

CONCLUSION

This research set out to study the phenomenon of the regular plural inside English compounds within the theory of base-driven stratification proposed by Giegerich (1999). In the theory, compounding and the regular plural are assigned to stratum 2. The main question concerned what motivates the regular plural to appear inside compounds to avoid generating otherwise unacceptable compounds such as **claws marks*.

The structure of this chapter is as follows: a synthesis of arguments and key issues presented in the research will be provided in (§ 1), followed by a discussion on the theoretical implications in (§ 2). In (§ 3), plans regarding further research on the topic will be outlined, followed by the conclusion in (§ 4).

1. SYNTHESIS

The first section of Chapter I explored how useful certain theories are in explaining the presence of the regular plural inside compounds: a lexical or syntactic theory of word formation. A comparison between lexicalism and distributed morphology (DM) showed that a two-system approach is indispensable in capturing the qualitative differences between lexical and phrasal constructions. Proponents of DM have attempted to account for such

differences, but DM still faces problems as a result of the demolition of not only morphology but also of the lexicon. Moreover, Williams (2007) argued that DM did not solve the empirical problems of lexicalism, but rather it was more concerned about reaching the same conclusions that lexicalism had reached. For example, with respect to the regular plural inside compounds, like some lexical stratification models, DM fails to account for its appearance, assuming that the internal plural morpheme always has idiosyncratic status (Siddiqi, 2006).

The second section of the chapter reviewed the theory of base-driven stratification that has directed the phenomenon in question. It was first proposed in Selkirk (1982) and largely developed by Giegerich (1999). A detailed comparison between affix- and base-driven models was provided, revealing that the base-driven model is superior to affix-driven stratification models (e.g. Kiparsky's level ordering, 1982). Concerning the morphological side of the theory, the model addresses the serious problems that discredited affix-driven stratification; for example, (i) a Class II prefix may precede a Class I suffix (e.g. *un#grammatical+ity*); (ii) a Class II suffix may precede a Class I suffix (e.g. *incre#ment+al*); (iii) affix-driven models fail to explain the ordering of affixes within the same stratum (e.g. **sensu+ous+ize*); and (iv) some affixes in both strata (e.g. *-able* → *cómparable* (stratum 1)/*compárable* (stratum 2)) have dual membership.

Unlike its predecessors, the base-driven theory, by placing the regular plural with compounding at the same stratum, recognises that not only

idiosyncratic plurals appear inside compounds. In relation to this particular issue, I discussed in the third section of the chapter the way in which the dichotomy between regular and irregular plurals within compounds (e.g. **claws marks* vs. *teeth marks*, respectively) has been used as supportive evidence for morphological and psycholinguistic theories such as level ordering, dual mechanism, and connectionism. Proponents of level-ordering and dual-mechanism models claim that the morphological constraint prevents the regular plural from appearing inside compounds (Kiparsky, 1982; Berent & Pinker, 2007, respectively), while proponents of connectionism have argued that the regular plural is processed in the associative memory like irregular plurals, but its absence inside a compound is attributed to semantic, phonological and orthographic features that affect the associative memory (Haskell et al., 2003; Buck-Gengler et al., 2004, respectively). The problem with these theories is that they assume a robust absence of a real regular plural morpheme as an internal inflection, which is inaccurate.

However, the base-driven stratification model, by assigning the regular plural and compounding to the same stratum, faces the problem of free interaction, thereby allowing for the generation of ill-formed compounds such as **cats lover* and **toys factory*. The important question that the research aimed to investigate was what motivates the non-idiosyncratic regular plural to interact with compounding at stratum 2. In relation to this question, I disagreed with the argument put forward by Lieber and Štekauer (2009) that

the phenomenon in question is purposeless and therefore should be bound up with that of linking elements. Both issues were discussed in detail in Chapter III. However, the discussion of lexicalism in chapter I (§ 1) involved a brief review of strong and weak lexical integrity hypotheses, which raised the question of whether the regular plural inflection should be generated inside the stratified lexicon. This question was important when discussing the interaction between the regular plural: Is it an interaction between two lexical rules? If not, how can we account for a syntactic rule inside a lexical rule? Chapter II was devoted to investigating this issue.

The first part of Chapter II reviewed three theories of the place of inflections: (i) Anderson (1982, 1992) argued for the split morphology hypothesis, suggesting that all inflections are generated outside the lexicon; (ii) Booij (1994, 1996, 1998) argued that all inflections are formed inside the lexicon; and (iii) Perlmutter (1988) suggested a weaker version of Anderson's theory, arguing that unproductive inflections are formed inside the lexicon, while productive inflections ought to be split from it. Anderson's main criterion is the relevancy of inflections to syntax. However, his theory was ruled out early in the chapter by evidence provided by proponents of the other theories. Booij (1996) demonstrated that inherent inflections and derivations are very similar and only contextual inflections are relevant to syntax. Perlmutter (1988) presented evidence from Yiddish showing that unproductive inflections may precede derivational affixes. At this point, Booij's perspective seemed equivocal; his evidence might be re-interpreted to

suggest that while the similarities between inherent inflections and derivation provide compelling evidence that both phenomena are generated in the lexicon, it is still possible that contextual inflections are generated extra-lexically, as Perlmutter theorised. Booij's lexical versus Perlmutter's syntactic accounts of contextual inflections were further investigated.

The outcome was that Booij's theory was borne out; the original assumption of the base-driven stratification model was maintained. This outcome was reached by investigating the status of the possessive inflection, which has been controversial; Anderson (2008, 2013) argued that it is not only a normal phrase-level inflection, but it has a special place in syntax. However, this claim was contradicted by three phenomena. First, the possessive inflection has suppletive forms, i.e. idiosyncratic possessive pronouns; Anderson's phrasal rule fails to apply to possessive pronouns in the head position (e.g. **you's lunch*). Second, it is sensitive to the morphological properties of the word to which it is attached; more specifically, it is phonologically lost in the presence of other homophonous inflections: the regular plural, the third-person singular present tense and the possessive affix.

A third phenomenon also contributed to this argument: the possessive inflection appears inside compounds. The status of the possessive affix inside a lexical construction has also been controversial in that it focused mainly on the status of the construction itself. For Anderson (2013), a 'descriptive genitive' is a syntactic construction, so it does challenge his theory of the

phrasal status of the possessive affix. For Shimamura (2000), it is a fixed expression like phrases found inside compounds; in other words, the internal possessive affix was originally a syntactic element that lost its status during the process of lexicalisation. Shimamura's claim then will not contradict Anderson's (1982) statement that "syntactic rules cannot make reference to any aspects of word-internal structure" (p. 573). However, I argued that both positions are difficult to maintain. Possessive compounds and noun-noun compounds showed similar features, structurally and semantically. They also showed the same problem of fuzziness; many compounds do not show pure lexical characteristics in terms of end-stress pattern or complete isolation from syntactic features. Phrases inside compounds are not always fixed expressions, as claimed by Shimamura (2000). A 'descriptive genitive' can be a compound and the appearance of the possessive inflection inside it is evidence that it is a lexical inflection. Its fuzzy nature can best be explained by the notion of modular overlap proposed by Giegerich (2005, 2009a) within the base-driven stratification theory, which is another advantage of this model. It provides a flexible solution for linguistic phenomena that show characteristics from both modules. Since the regular plural is generated in the lexicon at stratum 2, the question that had to be addressed in chapter III was what restricts its interaction with compounding.

Chapter III began with discussion of a debate on the semantic value of the regular plural inside compounds. Selkirk (1982) suggested that the regular plural reveals ambiguity, while Lieber and Štekauer (2009) claimed

that the regular plural should be regarded as a linking element because it has no function. Accordingly, the linking elements in German compounds were explored. They are relics of singular genitive inflections or plural suffixes; there is general agreement on their semantic emptiness (Wegener, 2008). In English, however, only a few English words exist whose internal inflection is similar to that found in German compounds, more specifically, as relics of the genitive inflection (e.g. *townsman*). Lieber and Štekauer's (2009) claim would have been supported if there were compounds whose internal plural suffix does not affect the singular interpretation of the non-head noun as in the German compound *Kinderstar* 'child star'. The regular plural does have a function. However, before proceeding to that discussion, three issues had to be addressed:

(a) *The confusion between the regular plural and the possessive morpheme within compounds:* In some compounds, the plural morpheme is obviously clear; in others, it might be confusing in terms of whether the morpheme is plural, possessive, or plural and possessive. This confusion was demonstrated by the compound *students union* (Krstev, Vitas, & Savary, 2006, p. 558). Therefore, the distribution of the possessive inflection inside compounds was investigated. A number of factors were suggested, but there was general agreement that animacy is a crucial motivator (Rosenbach, 2006, 2007; Taylor, 1996). Based on this factor, *students union* is more likely to carry the possessive; however, the construction is still ambiguous, whether the possessive is suppressed in the presence of a plural morpheme (i.e. *students'*

union) or not (i.e. *student's union*). Such a construction was excluded from the analysis of the function of the regular plural inside compound. On the other hand, a compound like *enemies list* was included in the analysis; such a compound is more likely to contain a possessive morpheme but the plural morpheme is clearly there, which is evident in its orthography (*enemy's list* vs. *enemies' list*). The interaction between the possessive inflection and compounding on stratum 2 was demonstrated by incorporating Lieber's (2004, 2009) mechanism of co-indexation. The semantic feature of the non-head element allows for the variation among speakers with respect to the use of the possessive as an internal inflection.

(b) *Pluralia tantum inside compounds*: The discussion was important to minimise the possibility that the internal plural is a plurale tantum and not a regular plural. For example, one might be tempted to analyse the function of the regular plural inside *admissions office*, while, in fact, it is not a regular plural but a type of pluralia tantum called 'pluralia tantum in specific sense only' by Johansson (1980), which means that *admissions* in that compound is not the plural form of *admission*, but it has a special meaning conveyed through the plural morpheme. Constructions with a potential plurale tantum were also excluded.

(c) *Plural phrases inside compounds*: Providing a reliable explanation for the purpose of the regular plural inside compounds required exclusion of compounds with embedded plural phrases. This was ensured by extracting from texts compounds whose plural non-heads are not independently

modified. For example, *buildings inspector* would sound strange, and one may claim that it does not exist without an adjectival modifier (e.g. *historic buildings inspector*) and the regular plural in this case is unproblematic. In fact, some texts showed that *the buildings inspector* existed, which then made it interesting to analyse the reason for using the regular plural inside it.

The final section of the chapter analysed the semantic function of the regular plural. The regular plural in all compounds involved in the analysis emphasises the meaning of 'many types', thus confirming Alegre and Gordon's (1999) and Sproat's (1985) suggestions that it is allowed if it is interpreted so. The regular plural, in this case, has a kind of ambiguity; the non-head noun has a generic interpretation that may refer to one type or many types, but the use of the regular plural confirmed the latter. However, this raised an interesting question; why is the meaning of 'many types' not always motivated? Take, for example, the difference between **pictures collection* and **paintings collection*, *books editor* and *?books shelf*. This suggested that other factors are involved.

Mass/count polysemy is involved in the appearance of the regular plural. The lexical items *picture* and *painting* are both countable, but the difference is that *painting* can be a mass noun as well. I demonstrated that compounds containing lexical items with this kind of polysemy accept the regular plural in compounds, suggesting that the regular plural can be used to prove countability. Text/object polysemy is also involved in the appearance of the regular plural. The left constituents of compounds with the

sense of texts rather than objects are more likely to accept the regular plural; *books editor* and *documents examiner* do not reveal the sense of ‘many tokens’ as in *?books shelf* and **documents database*. The regular plural inside compounds also resolves ambiguity resulting from adjective/noun polysemy that was illustrated by compounds such as *explosive production* and *explosives production*, *antiques shop* and *antique clock*. Again, the heterogeneous reading of the pluralised non-head is understandable, i.e. ‘many types of explosives’, ‘many types of antiques’. Finally, the BDS model was defended by discussing the effect of the semantic feature of the first element on the interaction between the regular plural and compounding on stratum 2. Here again I employed Lieber’s (2004, 2009) theory of co-indexation which, under certain conditions, allows for variation in the ultimate interpretation of the compound. The variation in the use of the regular plural inflection inside compounds has been attributed to the speaker’s preference for resolving the ambiguity and/or imposing the heterogeneity of the non-head noun.

2. THEORETICAL IMPLICATIONS

(a) A robust absence of the regular plural is inaccurate

Although compounds with an internal regular plural constitute the minority in comparison with compounds that do not accept such internal plurals, it is not infrequent or uncommon (Bergsten, 1911; Johansson, 1980) and thus should not be ignored.

The theories listed below have assumed a dichotomy between regular and irregular plurals within compounds; unlike irregular plurals, regular plurals never appear inside compounds. This kind of dichotomy has been used as supportive evidence for their structure of grammar:

Level ordering places the regular plural in a stratum after compounding.

The dual mechanism assumed two different systems, a mental grammar for regular inflections and a mental lexicon for irregular inflections.

Connectionism assumed one computational system, and the difference in the representation of the two types of inflections is attributed to semantic, phonological, and orthographic factors.

In chapter III, I argued that a real regular plural suffix appears inside compounds. A specific semantic function licensed its appearance. This, of course, means that evidence for any theory based on regular/irregular dichotomy inside compounds is not reliable. The structure of the lexicon in the base-driven stratification model recognises the dichotomy between the regular and irregular inflections but not within compounds. Irregular inflections are listed at stratum 1, so they are allowed to interact with compounding at stratum 2. The regular inflection and compounding are formed at stratum 2 and are also allowed to appear inside compounds, but they must be restricted.

(b) Inflections are not generated outside the lexicon

The discussion of the place of inflections in grammar in chapter II has implications for the direction of the analysis of the interaction between the regular plural and compounding, i.e. were we dealing with two different rules or two lexical rules? The outcome of the discussion supported the version of lexicalism suggesting that inflectional morphology is part of the lexicon. Hence, no changes occurred to the model adopted in the research; the regular plural remained at stratum 2 along with compounding. The evidence came from the properties of the possessive inflection. The possessive affix has been largely regarded as a phrasal affix; however, some of its properties are linked to morphology. The discussion refuted the split morphology hypothesis, both strong and weak versions.

(c) The regular plural inside compounds is real, not merely a linking element, a possessive inflection or a plurale tantum

The regular plural is homophonous to other morphemes that also happen to appear inside compounds: the linking element, a possessive inflection and a plurale tantum. A possessive inflection is largely motivated by the animacy of the left-constituent. A plurale tantum in many cases can be easily distinguished from the regular plural; however, in other cases, especially with 'pluralia tantum in specific sense only', a dictionary might be needed. The study showed that the regular plural that does not go under these three categories does occur.

(d) The regular plural inside compounds should not ultimately be bound up with a linking element

The discussion in chapter III refuted Lieber and Štekauer's (2009) view that the regular plural inside compounds should be regarded as a linking element; it clearly has a plural interpretation, but it is purposeless since the plural interpretation is understandable even with its absence. The semantic value of the regular plural was discussed with examples extracted from books. With the absence of the morpheme, there are two possibilities: the compound refers to 'one type' with many exemplars or 'many types'. Here, the morpheme can be used to 'emphasise' one meaning, i.e. 'many types'. This confirmed Sproat's (1985) and Alegre and Gordon's (1999) analysis of the function of the regular plural.

(e) Mass/count polysemy, text/object polysemy and adjective/noun polysemy contribute to the heterogeneous reading of the regular plural inside compounds

I demonstrated that these factors explain the difference between ill-formed compounds whose internal regular plural motivates the reading of 'many tokens' and well-formed compounds whose internal plural motivates the meaning of 'many types'.

(f) *The semantic function of the regular plural restricts its interaction with compounding at stratum 2*

The semantic function of the regular plural discussed in chapter III has implications regarding its interaction with compounding; it prevents the generation of unacceptable compounds (e.g. *computers lab). The regular plural is not allowed to appear inside compounds unless it carries the feature (+plural/+generic), which is motivated by the features (+count/-mass), (+text/-object), or (+N/-Adj). The study does not claim that these are the only factors involved.

3. FUTURE RESEARCH

For future research, it will be interesting to explore the optimality theory (OT) and examine its applicability to the phenomenon of the regular plural inside compounds. Two theoretical frameworks are of particular interest.

First is stratal OT which integrates two theories: lexical stratification and optimality theories (Kiparsky, 2007). At stratum 2, the interaction of faithfulness and markedness constraints govern the regular plural inside compounds. Second is Blunter's (1999) bidirectional OT within optimality theoretic semantics in which forms and meaning are interplayed. Consider the example in (1) below:

(1)	Form	Meaning
	painting collection f1	m1 one type of painting
	paintings collection f2	m2 different types of paintings

In OT, we have two candidate meanings of the same form *painting collection*, while *paintings collection* has only one candidate meaning. Blunter (1999) and Wunderlich (2001) argued that their model of OT can best deal with phenomena like ambiguity and synonymy.

Analysing the phenomenon within OT requires a descriptive generalisation which must be based on data (McCarthy, 2008). In other words, a data-based study will be required (e.g. an analysis of a large number of attested compounds) to examine whether factors other than those suggested in this research exist. Such factors would help to formulate a generalisation, from which constraints could be proposed; faithfulness constraints (F) that prevent the regular plural from interaction, and whose violation by markedness constraints (M) will result in compounds with pluralised non-heads.

4. Conclusion

Despite viewing the regular plural inside compounds as idiosyncratic or even a connective element, this study demonstrated that it is a real lexical suffix that acts as a disambiguator.

REFERENCES

- Abney, S. (1987). *The English noun phrase in its sentential aspect*. Indiana University, MIT. Retrieved from www.vinartus.com/spa/87a.pdf
- Ackema, P., & Neeleman, A. (2004). *Beyond morphology : interface conditions on word formation*. Oxford: Oxford University Press.
- Ackema, P., & Neeleman, A. (2007). Morphology ≠ syntax. In G. Ramchand & C. Reiss (Eds.), *Oxford handbooks in linguistics* (pp. 325-352). Oxford; New York: Oxford University Press.
- Acquaviva, P. (2008). *Lexical Plurals*. Oxford: Oxford University Press.
- Adams, V. (1973). *An introduction to modern English word-formation*. Harlow: Longman.
- Alegre, M., & Gordon, P. (1996). Red rats eater exposes recursion in children's word formation. *Cognition*, 60(1), 65-82.
- Alegre, M., & Gordon, P. (1999). *Why compounds researchers aren't rats eaters: semantic constraints on regular plurals inside compounds*.
- Allen, M. (1978). *Morphological investigations in English*. (PhD), University of Connecticut, Storrs.
- Altenberg, B. (1982). *The genitive v. the of-construction : a study of syntactic variation in 17th century English*. Lund: Gleerup.
- Anderson, S. (1982). Where's Morphology? *Linguistic Inquiry*, 13, 571-612.
- Anderson, S. (1988). Inflection. In M. Noonan & M. Hammond (Eds.), *Theoretical morphology : approaches in modern linguistics* (pp. 23-43). San Diego ; London: Academic Press.
- Anderson, S. (1992). *A-morphous morphology*. Cambridge: Cambridge University Press.
- Anderson, S. (2005). *Aspects of the theory of clitics*. New York: Oxford University.
- Anderson, S. (2008). The English "Group Genitive" is a special clitic. *English Linguistics*, 25, 1-20.

- Anderson, S. (2013). The marker of the English "group genitive" is a special clitic, not an inflection. In K. Börjars, D. Denison & A. Scott (Eds.), *Morphosyntactic categories and the expression of possession* (pp. 193-218). Amsterdam: John Benjamins.
- Apresjan, J. (1974). Regular polysemy. *Linguistics*, 12(142), 5-32.
- Aronoff, M. (1976). *Word formation in generative grammar*. Cambridge, Mass.: MIT Press.
- Aronoff, M. (1994). *Morphology by itself : stems and inflectional classes*. Cambridge, Mass. ; London: MIT Press.
- Aronoff, M., & Fuhrhop, N. (2002). Restricting suffix combinations in German and English: Closing suffixes and the monosuffix constraint. *Natural Language & Linguistic Theory*, 20(3), 451-490.
- Baayen, H. (1992). Quantitative aspects of morphological productivity. In G. Booij & J. van Marle (Eds.), *Yearbook of morphology 1991* (pp. 27-50). Netherlands: Springer
- Bache, C., & Davidsen-Nielsen, N. (1997). *Mastering English : an advanced grammar for non-native and native speakers*. Berlin ; New York: Mouton de Gruyter.
- Barfoot, C. (1991). Trouble with the apostrophe: Or, "you know what hairdresser's are like". In I. Tieken-Boon Van Ostade, J. Frankis, N. E. Osselton & C. Ewen (Eds.), *Language usage and description : studies presented to N.E. Osselton on the occasion of his retirement* (pp. 121- 137). Amsterdam ; Atlanta GA.
- Bauer, L. (1983). *English word-formation*. Cambridge: Cambridge University Press.
- Bauer, L. (1990). Be-heading the word. *Journal of Linguistics*, 26, 1-31.
- Bauer, L. (1998). When is a Sequence of Two Nouns a Compound in English? *English Language and Linguistics*, 2, 65-86.
- Bauer, L. (2003). *Introducing linguistic morphology*. Edinburgh: Edinburgh University Press.
- Bauer, L. (2005). Productivity: Theories. In P. Štekauer & R. Lieber (Eds.), (2005). *Handbook of word-formation*. Dordrecht: Springer.

- Bauer, L. (2006). Compounds and minor word-formation types. In B. Aarts & A. McMahon (Eds.), *The handbook of English linguistics* (pp. 483-506). Malden, Mass.: Blackwell Pub.
- Bauer, L., & Renouf, A. (2001). A corpus-based study of compounding in English. *Journal of English Linguistics*, 29, 101-123.
- Bell, M. (2012). *The English noun-noun construct: A morphological and syntactic object*. Greece: University of Patras Retrieved from http://imgd.philology.upatras.gr/en/research/downloads/MMM8_Proceedings.pdf#page=59.
- Berent, I., & Pinker, S. (2007). The dislike of regular plurals in compounds: Phonological familiarity or morphological constraint? *The Mental Lexicon*, 2(2), 129-181.
- Bergsten, N. (1911). *A study of compound substantives in English*. Uppsala: Almqvist & Wiksell
- Bermúdez-Otero, R., & Payne, J. (2011). There are no special clitics. In A. Galani, G. Hicks & G. Tsoulas (Eds.), *Morphology and its interfaces* (pp. 57-96). Amsterdam: John Benjamins.
- Blank, A. (2003). Polysemy in the lexicon and in discourse. In B. Nerlich, Z. Todd, V. Herman & D. Clarke (Eds.), *Polysemy: Flexible patterns of meaning in mind and language* (pp. 267-293). Berlin: Mouton de Gruyter.
- Blutner, R. (2000). Some aspects of optimality in natural language interpretation. *Journal of semantics*, 17(3), 189-216.
- Bock, J., Eberhard, K., Cutting, J., Meyer, A., & Schriefers, H. (2001). Some attractions of verb agreement. *Cognitive Psychology*, 43, 83-128.
- Bock, K., & Eberhard, K. (1993). Meaning, sound, and syntax in English number agreement. *Language and Cognitive Processes*, 8, 57-99.
- Booij, G. (1985). The interaction of phonology and morphology in prosodic phonology. In E. Gussmann (Ed.), *Phono-morphology: Studies in the interaction of phonology and morphology* (pp. 23-34). Lublin: Katolicki Uniwersytet Lubelski.
- Booij, G. (1994). Against split morphology 1993. In G. Booij & J. van Marle (Eds.), *Yearbook of morphology 1993* (pp. 27-50). Dordrecht: Kluwer.

- Booij, G. (1996). Inherent versus contextual inflection and the split morphology hypothesis. In G. Booij & J. van Marle (Eds.), *Yearbook of Morphology 1995* (pp. 1-16). Dordrecht: Kluwer.
- Booij, G. (1998). The demarcation of inflection: a synoptical survey. In F. Fabri, A. Ortmann & T. Parodi (Eds.), *Models of Inflection* (pp. 11-27). Tübingen: Niemeyer.
- Booij, G. (2002). *The morphology of Dutch*. Oxford: Oxford University Press.
- Borer, H. (1984). *The projection principle and rules of morphology*. Paper presented at the Proceedings of the Fourteenth Annual Meeting of NELS, Amherst.
- Botha, R. (1981). A Base rule theory of Afrikaans synthetic compounding. In M. Moortgat, H. van der Hulst & T. Hoekstra (Eds.), *The Scope of lexical rules* (pp. 1-77). Dordrecht: Foris.
- Bouillon, P., & Viegas, E. (1994). A semi-polymorphic approach to the interpretation of adjectival constructions: A cross-linguistic perspective. In W. Martin, W. Meijs, M. Moerland, E. ten Pas, P. van Sterkenburg & P. Vossen (Eds.), *Proceedings of the Sixth EURALEX International Congress* (pp. 36-44). Amsterdam: Free University of Amsterdam.
- Brinton, L., & Brinton, D. (2010). *The linguistic structure of modern English*. Amsterdam: John Benjamins Publishing Company.
- Buck-Gengler, C., Menn, L., & Healy, A. (2004). What 'mice trap' tells us about the mental lexicon. *Brain and Language*, 90, 453-464.
- Carstairs-McCarthy, A. (2002). *An introduction to English morphology : words and their structure*. Edinburgh: Edinburgh University Press.
- Carstairs-McCarthy, A. (2005). Phrases inside compounds: A puzzle for lexicon-free morphology. *SKASE Journal of Theoretical Linguistics*, 2(3), 34-42.
- Chierchia, G. (1998). Plurality of mass nouns and the notion of "semantic parameter". In S. Rothstein (Ed.), *Events and grammar* (pp. 53-103). Dordrecht: Kluwer.
- Chomsky, N. (1965). *Aspects of the theory of syntax*. Cambridge, Mass.: MIT Press.

- Chomsky, N. (1970). Remarks on nominalization. In R. Jacobs & P. Rosenbaum (Eds.), *Readings in English Transformational Grammar* (pp. 184-221). Waltham MA: Ginn.
- Chomsky, N., & Halle, M. (1968). *The sound pattern of English*. New York: Harper & Row.
- Clahsen, H. (1995). German plurals in adult second language development. In L. Eubank, L. Selinker & S. S. (Eds.), *The current state of interlanguage: Studies in honor of William E. Rutherford* (pp. 123- 137). Amsterdam: John Benjamins.
- Clahsen, H., Marcus, G., Bartke, S., & Wiese, R. (1996). Compounding and inflection in German child language. In G. Booij & J. van Marle (Eds.), *Yearbook of Morphology 1995* (pp. 115-142). Dordrecht: Kluwer.
- Clahsen, H., Rothweiler, M., Woest, A., & Marcus, G. (1992). Regular and irregular inflection in the acquisition of German noun plurals. *Cognition*, 45, 225-255.
- Clahsen, H., Sonnenstuhl, I., & Blevins, J. (2003). Derivational morphology in the German mental lexicon: a dual-mechanism account. In H. Baayen & R. Schreuder (Eds.), *Morphological structure in language processing* (pp. 125-155). Berlin: Mouton de Gruyter.
- Collins, C. (1991). *Notes on Dutch morphology*. Department of Brain & Cognitive Sciences. MIT.
- Corbett, G. (2000). *Number*. Cambridge: Cambridge University Press.
- Cummings, I., & Clahsen, H. (2007). The time-course of morphological constraints: Evidence from eye-movements during reading. *Cognition*, 104(3), 476-494.
- Cuyckens, H., & Zawada, B. (2001). *Polysemy in cognitive linguistics*. Paper presented at the The fifth international cognitive linguistics conference University of Amsterdam.
- Dabrowska, E. (1998). How metaphor affects grammatical coding: The Saxon genitive in computer manuals. *English Language and Linguistics*, 2, 121-127.
- Dalrymple, M., & Nikolaeva, I. (2006). Syntax of Natural and Accidental Coordination: Evidence from Agreement. *Language*, 82(4), 824-849.

- Denison, D., Scott, A., & Borjars, K. (2010). The real distribution of the English group genitive. *Studies in Language*, 34(3), 532-564.
- Di Sciullo, A.-M., & Williams, E. (1987). *On the definition of word*. Cambridge, Mass. ; London: MIT Press.
- Dixon, R., & Aikhenvald, A. (Eds.) (2002). *Word: A cross-linguistic typology*. Cambridge: CUP.
- Dressler, W., Libben, G., Stark, J., Pons, C., & Jarema, G. (2001). The processing of interfixed German compounds. In G. Booij & J. van Marie (Eds.), *Yearbook of morphology 1999* (pp. 185-220). Dordrecht: Kluwer.
- Embick, D., & Noyer, R. (2007). Distributed morphology and the syntax-morphology interface. In G. Ramchand & C. Reiss (Eds.), *The Oxford handbook of linguistic interfaces* (pp. 289-324). Oxford: Oxford University Press.
- Fabb, N. (1984). *Syntactic affixation*. (Ph. D.), Massachusetts Institute of Technology, Cambridge, Mass.
- Fabb, N. (1988). English suffixation is constrained only by selectional restrictions. *Natural Language and Linguistic Theory*, 6, 527-539.
- Fabb, N. (1998). Compounding. In A. Spencer & A. Zwicky (Eds.), *The handbook of morphology* (pp. 66-83). Oxford: Blackwell.
- Falkum, I. (2010). *Systematic polysemy and the count-mass distinction*. Paper presented at the UCL Working Papers in Linguistics. <http://www.ucl.ac.uk/psychlangsci/research/linguistics/publications/wpl/10papers/Falkum2010>
- Giegerich, H. (1999). *Lexical strata in English : morphological causes, phonological effects*. Cambridge: Cambridge University Press.
- Giegerich, H. (2004). Compound or phrase? English noun-plus-noun constructions and the stress criterion. *English Language and Linguistics*, 8, 1-24.
- Giegerich, H. (2005). Lexicalism and modular overlap in English. *SKASE Journal of Theoretical Linguistics*, 2(2), 43-62.

- Giegerich, H. (2009a). Compounding and lexicalism. In R. Lieber & P. Štekauer (Eds.), *The Oxford handbook of compounding* (pp. 178-200). Oxford: Oxford University Press.
- Giegerich, H. (2009b). Compounding and lexicalism. (pp. 1-24).
<http://www.lel.ed.ac.uk/aboutus/people/heinz/lexicalismandcompounding.pdf>
- Giegerich, H. (2009c). The English compound stress myth. *Word Structure*, 2(1), 1-17.
- Glover, K. (2005). *Polysemy. Methods and materials. Models and meanings* (MA), University of Essex. Retrieved from
<http://www.essex.ac.uk/linguistics/dissertations/2005/docs/Glover.pdf>
- Goldberg, A., & Jackendoff, R. (2004). The English resultative as a family of constructions. *Language*, 80, 532-568.
- Gordon, P. (1985). Level-ordering in lexical development. *Cognition*, 21, 73-93.
- Graves, P. G. (1990). *German grammar*. New York: Barron's Educational.
- Halle, M., & Marantz, A. (1993). Distributed morphology and the pieces of inflection. In K. H. S. J. Keyser (Ed.), *A view from building 20: Essays in linguistics in honor of Sylvian Bromberger* (pp. 111-176). Cambridge, Mass.: MIT Press.
- Halle, M., & Mohanan, K. (1985). Segmental phonology of modern English. *Linguistic Inquiry*, 16, 57-116.
- Halpern, A. L. (1995). *On the placement and morphology of clitics*. Stanford, Calif: CSLI Publications.
- Harley, H. (2009). Compounding in distributed morphology. In R. Lieber & P. Štekauer (Eds.), *The Oxford handbook of compounding* (pp. 129-144). Oxford: Oxford University Press.
- Harley, H., & Noyer, R. (1999). State-of-the-article: Distributed morphology. *Glott International*, 4(4), 3-9.
- Harley, H., & Noyer, R. (2000). Formal vs. encyclopaedic properties of vocabulary: Evidence from nominalizations. In B. Peeters (Ed.), *The lexicon/encyclopaedia interface* (pp. 349-374). Amsterdam: Elsevier Press.

- Haskell, T., MacDonald, M., & Seidenberg, M. (2003). Language learning and innateness: Some implications of compounds research. *Cognitive Psychology*, 47, 119-163.
- Hoeksema, J. (1992). The head parameter in morphology and syntax. In D. Gilbers & S. Looyenga (Eds.), *Language and Cognition 2* (pp. 119-132). Groningen: De Passage.
- Hohenhaus, P. (2005). Lexicalisation and institutionalisation. In P. Štekauer & R. Lieber (Eds.), *Handbook of English word-formation* (pp. 353-373). Dordrecht: Springer.
- Huddleston, R. (1984). *Introduction to the grammar of English*. Cambridge: Cambridge University Press.
- Huddleston, R., & Pullum, G. (2002). *The Cambridge grammar of the English language*. Cambridge: Cambridge University Press.
- Hundt, M. (1998). *New Zealand English grammar – Fact or fiction? A corpus-based study in morphosyntactic variation*. Amsterdam: John Benjamins.
- Hüning, M. (2010). Adjective + noun constructions between syntax and word formation in Dutch and German. In A. Onysko & S. Michel (Eds.), *Cognitive perspectives on word formation* (pp. 195– 215). Berlin: Mouton De Gruyter.
- Jahr Sorheim, M. (1980). *the s-genitive in Present-day English*. University of Oslo.
- Jespersen, O. (1954). *A modern English grammar on historical principles, part II. Syntax, Vol. 2*. Copenhagen; London: George Allen & Unwin LTD.
- Johansson, S. (1980). *Plural attributive nouns in present-day English*. Lund: CWK Gleerup.
- Katamba, F. (1993). *Morphology*. Basingstoke: Macmillan.
- Katamba, F. (2004). *Morphology : critical concepts in linguistics* (Vol. 1). London ; New York: Routledge.
- Kearns, K. (2006). Lexical semantics. In B. Aarts & A. McMahon (Eds.), *The handbook of English linguistics*. Malden, Mass.; Oxford: Blackwell Pub.

- Kiparsky, P. (1973). Elsewhere in phonology. In S. Anderson & P. Kiparsky (Eds.), *A Festschrift for Morris Halle* (pp. 93-106). New York: Holt, Rinehart and Winston.
- Kiparsky, P. (1982). Lexical phonology and morphology. In I. Yang (Ed.), *Linguistics in the morning calm* (pp. 3-91). Seoul: Hanshin.
- Kiparsky, P. (2000). "Opacity and Cyclicity". *The Linguistic Review*, 17, 351-366.
- Koester, D., Gunter, T., Wagner, S., & Friederici, A. (2004). Morphosyntax, prosody, and linking elements: The auditory processing of German nominal compounds. *Journal of Cognitive Neuroscience*, 16(9), 1647-1668.
- Krstev, C., Vitas, D., & Savary, A. (2006). *Prerequisites for a comprehensive dictionary of Serbian compounds*. Paper presented at the 5th International Conference: Advances in Natural Language Processing Turku, Finland.
- Lapointe, S. (1980). *The theory of grammatical agreement*. University of Massachusetts. Amherst.
- Lapointe, S. (1990). *EDGE features in GPSG*. Paper presented at the CLS 26 : papers from the 26th regional meeting of the Chicago Linguistic Society, Chicago.
- Lees, R. (1960). *The grammar of English nominalizations*. Bloomington, Ind.: Indiana University.
- Liberman, M., & Prince, A. (1977). On Stress and Linguistic Rhythm. *Linguistic Inquiry*, 8, 249-336.
- Liberman, M., & Sproat, R. (1992). The stress and structure of modified noun phrases in English. In I. Sag & A. Szabolcsi (Eds.), *Lexical matters* (pp. 131-181). Stanford: Stanford University Press.
- Lieber, R. (1981). *On the organization of the lexicon*. Bloomington: Indiana University Linguistics Club.
- Lieber, R. (1983). Argument linking and compounds in English. *Linguistic Inquiry*, 14, 251-286.
- Lieber, R. (1992a). Compounding in English. *Rivista di Linguistica*, 4, 79- 96.

- Lieber, R. (1992b). *Deconstructing morphology : word formation in syntactic theory*. Chicago ; London: University of Chicago Press.
- Lieber, R. (2004). *Morphology and lexical semantics*. Cambridge: Cambridge University Press.
- Lieber, R. (2009). A lexical semantic approach to compounding. In R. Lieber & P. Stekauer (Eds.), *The Oxford Handbook of Compounding* (pp. 78-104). Oxford: Oxford University Press.
- Lieber, R., & Scalise, S. (2006). The lexical integrity hypothesis in a new theoretical universe. *Lingue e linguaggio*, 1, 7-32.
- Lieber, R., & Štekauer, P. (Eds.) (2009). *The Oxford handbook of compounding*. Oxford: Oxford University Press.
- Lipka, L. (2005). Lexicalization and institutionalization: Revisited and extended. *SKASE Journal of Theoretical Linguistics*, 2(2), 40-42.
- Lyons, J. (1977). *Semantics*. Cambridge ; New York: Cambridge University Press.
- Marantz, A. (1997). No escape from syntax: Don't try morphological analysis in the privacy of your own lexicon. In A. Dimitriadis, L. Siegel, C. Surek-Clark & A. Williams (Eds.), *Proceedings of the 21st Annual Penn Linguistics Colloquium* (pp. 201-225). Philadelphia: University of Pennsylvania.
- Marantz, A. (2001). *Words*. Paper presented at the West Coast Conference on Formal Linguistics, University of Southern California Los Angeles. <http://web.mit.edu/marantz/Public/EALING/WordsWCCFL.pdf>
- Marantz, A. (2007). Phases and words. In S. Choe (Ed.), *Phases in the theory of grammar* (pp. 191-222). Seoul: Dong.
- Marchand, H. (1965a). On the analysis of substantive compounds and suffixal derivatives not containing a verbal element. *Indogermanische Forschungen*, 70, 117-145.
- Marchand, H. (1965b). The analysis of verbal nexus substantives. *Indogermanische Forschungen*, 70, 57-71.
- Marchand, H. (1969). *The categories and types of present-day English word-formation : a synchronic-diachronic approach* (Second, completely revised and enlarged edition. ed.). München: Beck.

- Marcus, G. (2000). Children's overregularisation and its implication for cognition. In P. Broeder & J. Murre (Eds.), *Models of Language Acquisition: Inductive and deductive approaches* (pp. 154-176). Oxford: Oxford University Press.
- Marcus, G., Brinkmann, U., Clahsen, H., Wiese, R., & Pinker, S. (1995). German inflection: The exception that proves the rule. *Cognitive Psychology*, 29, 189-256.
- McCarthy, J. J. (2008). *Doing optimality theory : applying theory to data*. Malden, Mass. ; Oxford: Blackwell Pub.
- Miller, P. (1992). *Clitics and constituents in phrase structure grammar*. New York: Garland.
- Mohanan, K. (1982). *Lexical phonology*. (Ph.D. thesis), M.I.T., Bloomington, Ind.
- Mohanan, K. (1986). *The theory of lexical phonology*. Dordrecht ; Lancaster: Reidel.
- Montgomery, B. (2001). *Studies in German and English morphology with special reference to 'linking elements'*. (Ph.D. thesis), University of Edinburgh.
- Murphy, V. (2000). Compounding and the representation of L2 inflectional morphology. *Language Learning*, 50, 153-197.
- Neef, M. (2009). IE, Germanic: German. In R. Lieber & P. Štekauer (Eds.), *The Oxford handbook of compounding* (pp. 386-399). Oxford: Oxford University Press.
- Nevis, J. (1985). *Finnish particle clitics and general clitic theory*. Columbus: Ohio State University.
- Nübling, D., & Szczepaniak, R. (2008). On the way from morphology to phonology: German linking elements and the role of the phonological word. *Morphology*, 18(1), 1-25.
- Nunberg, G. (1978). *The pragmatics of reference*. (Ph.D. thesis), City University of New York, Bloomington, Ind.
- Nunberg, G. (1979). The non-uniqueness of semantic solutions: Polysemy. *Linguistics and Philosophy*, 3(2), 143-184.
- Olsen, S. (2000). Compounding and Stress in English. *Linguistische Berichte*, 181, 55-69.

- Padrosa-Trias, S. (2010). *Complex word-formation and the morphology syntax interface* (Ph.D thesis), Universitat Autònoma de Barcelona. Retrieved from http://filcat.uab.cat/clt/publicacions/tesis/pdf/Complex%20word%20formation_Padrosa.pdf
- Payne, J. (2009). The English genitive and double case. *Transactions of the Philological Society*, 107(3), 322-357.
- Payne, J., & Huddleston, R. (2002). Nouns and noun phrases. In R. Huddleston & G. Pullum (Eds.), *The Cambridge grammar of the English language* (pp. 323-523). Cambridge: Cambridge University Press.
- Payne, T. (2011). *Understanding English grammar : a linguistic introduction*. Cambridge: Cambridge University Press.
- Perlmutter, D. (1988). The split morphology hypothesis: Evidence from Yiddish. In M. Hammond & M. Noonan (Eds.), *Theoretical morphology: Approaches in modern linguistics* (pp. 79-100). San Diego: Academic Press.
- Pethő, T. (2007). On Irregular Polysemy. In P. Marina, P. Gergely & R. Csilla (Eds.), *The cognitive basis of polysemy: New sources of evidence for theories of word meaning* (pp. 123-156). Frankfurt, Main: Peter Lang.
- Pinker, S. (1999). *Words and rules : the ingredients of language*. London: Weidenfeld & Nicolson.
- Pinker, S., & Prince, A. (1988). On language and connectionism: Analysis of a parallel distributed model of language acquisition. *Cognition*, 28, 73-193.
- Pinker, S., & Prince, A. (1992). Regular and irregular morphology and the psychological status of rules of grammar. In L. Sutton, C. Johnson & R. Shields (Eds.), *Proceedings of the 17th Annual Meeting of the Berkeley Linguistics Society* (pp. 230-251). Berkeley: Berkeley Linguistics society.
- Plag, I. (1996). Selectional restrictions in English suffixation revisited: a reply to Fabb (1988). *Linguistics*, 34(4), 769-798.
- Plag, I. (2003). *Word-formation in English*. Cambridge: Cambridge University Press.
- Plag, I., Braun, M., Lappe, S., & Schramm, M. (2009). *Introduction to English linguistics*. Berlin ; New York: Mouton De Gruyter.

- Plag, I., Kunter, G., Lappe, S., & Braun, M. (2008). The role of semantics, argument structure, and lexicalization in compound stress assignment in English. *Language*, 84, 760–794.
- Pustejovsky, J. (1995). *The generative lexicon*. Cambridge, Mass ; London: MIT Press.
- Pustejovsky, J., & Boguraev, B. (1996). *Lexical semantics : the problem of polysemy*. Oxford: Clarendon Press.
- Quirk, R., Greenbaum, S., Leech, G., & Svartvik, J. (1972). *A grammar of contemporary English*. London: Longman.
- Quirk, R., Greenbaum, S., Leech, G., & Svartvik, J. (1985). *A Comprehensive grammar of the English language*. London: Longman.
- Radford, A. (2004). *English syntax : an introduction*. Cambridge, UK ; New York: Cambridge University Press.
- Radford, A. (2006). *English syntax: An introduction*. University of Essex.
- Roeper, T., & Siegel, M. (1978). A lexical transformation for verbal compounds. *Linguistic Inquiry*, 9, 199-260.
- Rosenbach, A. (2002). *Genitive variation in English : conceptual factors in synchronic and diachronic studies*. Berlin: Mouton de Gruyter.
- Rosenbach, A. (2006). Descriptive genitives in English: A case study on constructional gradience. *English Language and Linguistics*, 10, 77-118.
- Rosenbach, A. (2007). Emerging variation: Determiner genitives and noun modifiers in English. *English Language and Linguistics*, 11, 143-189.
- Rosenbach, A. (2008). Animacy and grammatical variation—Findings from English genitive variation. *Lingua*, 118(2), 151-171.
- Scalise, S. (1988). Inflection and derivation. *Linguistics*, 26(4), 561-582.
- Schwartz, L. (2002). *Corpus-based acquisition of head noun countability features* (MA dissertation), University of Cambridge.
- Selkirk, E. (1982). *The syntax of words*. Cambridge, Mass.; London: MIT Press.
- Senghas, A., Kim, J., & Pinker, S. (2007). *Plurals-inside compounds: morphological constraints and their implications*. Barnard college.

- Senghas, A., Kim, J., Pinker, S., & Collins, C. (1991). *Plurals-inside compounds: morphological constraints and their implications for acquisition*. Paper presented at the the sixteenth annual Boston University conference on language development.
- Shimamura, R. (2000). *Lexicalization of syntactic phrases: the case of genitive compounds*. Tsuda College.
- Siddiqi, D. (2006). *Minimize exponence: Economy effects on a model of the morphosyntactic component of the grammar* (Ph.D. thesis), University of Arizona. Retrieved from http://babel.ucsc.edu/~hank/mrg.readings/Siddiqi_Diss.pdf
- Siddiqi, D. (2009). *Syntax within the word: economy, allomorphy, and argument selection in distributed morphology*. Amsterdam: John Benjamins Publishing Company.
- Siegel, D. (1974). *Topics in English morphology*. (Ph.D. thesis), Massachusetts Institute of Technology.
- Siegel, D. (1979). *Topics in English morphology*. New York: Garland Pub.
- Sklar, E. (1976). The possessive apostrophe: The development and decline of a crooked mark. *College English*, 38, 175- 183.
- Sneed, E. (2002). The acceptability of regular plurals in compounds. In M. Andronis, E. Debenport, A. Pycha & K. Yoshimura (Eds.), *Proceedings of CLS 38* (pp. 617-631). Chicago: Chicago Linguistics Society.
- Spencer, A. (1988). Bracketing paradoxes and the English lexicon. *Language*, 64, 663-682.
- Spencer, A. (1991). *Morphological theory : an introduction to word structure in generative grammar*. Oxford: Basil Blackwell.
- Spencer, A. (2000). Morphology and Syntax. In G. Booij, C. Lehmann & J. Mugdan (Eds.), *Morphology: An international handbook on inflection and word-formation* (pp. 312-335). Berlin: Walter de Gruyter.
- Spencer, A. (2001). The word-and-paradigm approach to morphosyntax. *Transactions of the Philological Society*, 99, 279-313.

- Spencer, A. (2003). Does English have productive compounding? In G. Booij, J. DeCesaris, A. Ralli & S. Scalise (Eds.), *Topics in morphology: selected papers from the third Mediterranean morphology meeting* (pp. 329–341). Barcelona: Universitat Pompeu Fabra.
- Spencer, A., & Luís, A. (2012). Canonical clitics. In D. Brown, M. M. Chumakina & G. Corbett (Eds.), *Canonical morphology and syntax* (pp. 123–150). Oxford: Oxford University Press.
- Sproat, R. (1985). *On deriving the lexicon*. Bloomington: MIT.
- Strauss, S. (1982). On "Relatedness Paradoxes" and Related Paradoxes. *Linguistic Inquiry*, 13, 694-700.
- Stump, G. (1998). Inflection. In A. Spencer & A. Zwicky (Eds.), *The handbook of morphology* (pp. 13–43). Oxford: Blackwell.
- Stump, G. (2001). *Inflectional morphology : a theory of paradigm structure*. Cambridge: Cambridge University Press.
- Tallerman, M. (2013). *Understanding syntax*. London: Routledge.
- Taylor, J. (1996). *Possessives in English : an exploration in cognitive grammar*. Oxford: Clarendon Press.
- Trousdale, G. (2008). A constructional approach to lexicalization processes in the history of English: Evidence from possessive constructions. *Word Structure*, 1(2), 156-177.
- Venezky, R. (1999). *The American way of spelling: The structure and origins of American English orthography*. New York: Guilford.
- Vikner, C., & Jensen, P. (2002). A semantic analysis of the English genitive. Interaction of lexical and formal semantics. *Studia Linguistica*, 56(2), 191-226.
- Ward, G., Sproat, R., & McKoon, G. (1991). A pragmatic analysis of so-called anaphoric islands. *Language*, 67, 439-474.
- Wegener, H. (2008). The regrammaticalization of linking elements in German. In S. Seoane & M. LópezCouso (Eds.), *Theoretical and empirical issues in grammaticalization* (pp. 333–354). Amsterdam: Benjamins.
- Wiese, R. (1996). Phrasal compounds and the theory of word syntax. *Linguistic Inquiry*, 27, 183-193.

- Williams, E. (1981). On the notions "lexically related" and "head of a word". *Linguistic Inquiry*, 12(2), 245-274.
- Williams, E. (2007). Dumping lexicalism. In G. Ramchand & C. Reiss (Eds.), *The Oxford handbook of linguistic interfaces* (pp. 353-381). Oxford: Oxford University Press
- Wiltschko, M. (2008). The syntax of non-inflectional plural marking. *Natural Language & Linguistic Theory*, 26(3), 639-694.
- Wunderlich, D. (2001). *Bidirectional OT in morphology*. University of Düsseldorf.
- Zawada, B. (2007). Conceptual integration and intercategory polysemy. *Language Matters: Studies in the Languages of Africa*, 38(1), 150-175.
- Zwicky, A. (1977). *On clitics*. Bloomington: Indiana University Linguistics Club.
- Zwicky, A. (1985). Rules of allomorphy and syntax-phonology interactions. *Journal of Linguistics*, 21, 431-436.
- Zwicky, A. (1987). Suppressing the Zs. *Journal of Linguistics*, 23, 133-148.
- Zwicky, A., & Pullum, G. (1983). Cliticization vs. inflection: English n't. *Language*, 59, 502-513.

REFERENCES TO TEXTS TAKEN FROM GOOGLE BOOKS

- Adefuye, A. (1993). *Seven years of IBB: Foreign policy* Retrieved from <http://books.google.co.uk/books?id=52MuAQAAIAAJ&q=Seven+Years+of+IBB:+Foreign+Policy+books+editor&dq=Seven+Years+of+IBB:+Foreign+Policy+books+editor&hl=en&sa=X&ei=z2ZtUq7OCuiI0AWpy4DQCA&ved=0CEUQ6AEwAQ>
- Arslan, F. (2005). *September 11 fiction of matrix* Retrieved from <http://books.google.co.uk/books?id=1a8obtp0ni4C&pg=PA107&dq=After+the+Gulf+War+he+worked+in+Iraq+as+a+weapon+inspector+between&hl=en&sa=X&ei=nFZtUsbuNamc0wW31YGgCA&ved=0CDMQ6AEwAA#v=snippet&q=weapon%20inspector%20&f=false>

- Becker, I. (2011). *Comprehensive occlusal concepts in clinical practice* Retrieved from [http://books.google.co.uk/books?id=EIGVmuE1iWAC&pg=PA2015&dq=Milam+\(2005\)+elucidated+that+reperfusion+with+delivery+of+oxygen+to+cell+populations+previously+exposed+to+hypoxic+conditions+can+lead+to+an+explosive+production+of+oxygen+derived+free+radicals&hl=en&sa=X&ei=VGptUvTXMOeV0QXC14GACA&ved=0CDYQuwUwAA#v=snippet&q=explosive%20production%20&f=false](http://books.google.co.uk/books?id=EIGVmuE1iWAC&pg=PA2015&dq=Milam+(2005)+elucidated+that+reperfusion+with+delivery+of+oxygen+to+cell+populations+previously+exposed+to+hypoxic+conditions+can+lead+to+an+explosive+production+of+oxygen+derived+free+radicals&hl=en&sa=X&ei=VGptUvTXMOeV0QXC14GACA&ved=0CDYQuwUwAA#v=snippet&q=explosive%20production%20&f=false)
- Bollinger, L. (1994). *Images of a free press* Retrieved from <http://books.google.co.uk/books?id=NXqDUxL-h8QC&pg=PA195&dq=The+enemy+list+contained+a+total+of+fifty-six+reporters,+editors,+columnists,+and+television+commentators%E2%80%99&hl=en&sa=X&ei=c45tUtGpJuSr0QWwz4GoCA&ved=0CDMQ6AEwAA#v=onepage&q=the%20enemy%20list&f=false>
- Booth, T., & Dyson, M. (2003). *Building your own home: The ultimate guide to managing a self-build project and creating your dream house* Retrieved from <http://books.google.co.uk/books?id=Vz1K7GP3SdAC&pg=PA136&dq=Building+inspectors+are+concerned+about+the+building+work+it+self&hl=en&sa=X&ei=pWVtUsydK6Ok0QXoq4CIBg&ved=0CDMQ6AEwAA#v=onepage&q=Building%20inspectors%20&f=false>
- Brouwer, F. (2012). *The economics of regulation in agriculture* Retrieved from <http://books.google.co.uk/books?id=V18FD4UmX-gC&pg=PA148&dq=The+next+section+discusses+some+sustainability+issues+with+respect+to+cereals+production.+The+following+section+provides+an+overview+of+cereal+production+and+trade+aimed+at+getting+further+insight+into+the+particular+structure+of+cereal+markets+and+trade&hl=en&sa=X&ei=WGxtUpWmIerH0QX1g4HACg&ved=0CDYQuwUwAA#v=onepage&q=The%20next%20section%20discusses%20some%20sustainability%20issues%20with%20respect%20to%20cereals%20production&f=false>
- Colin, B. (2012). *Strip the willow* Retrieved from <http://books.google.co.uk/books?id=0DshkWsmn5EC&printsec=frontcover&dq=Strip+the+Willow&hl=en&sa=X&ei=g1xtUqW3HYmd0AXzgoH4CQ&ved=0CDMQ6AEwAA#v=onepage&q=drink%20cabinet%20&f=false>

- Dorrien, G. (2010). *Economy, difference, empire* Retrieved from <http://books.google.co.uk/books?id=QZg7AAAAQBAJ&pg=PT313&dq=Former+U.N.+weapons+inspector+Scott+Ritter+gave+a+different+picture+of+the+weapons+issue&hl=en&sa=X&ei=5VVtUpGDF8G00wW87oDACg&ved=0CDMQ6AEwAA#v=onepage&q=weapons%20inspector%20Scott%20Ritter%20&f=false>
- Eberts, M. (1992). *Careers for culture lovers and other artsy types* Retrieved from <http://books.google.co.uk/books?id=ErnZIwAACAAJ&dq=Careers+for+Culture+Lovers+and+Other+Artsy+Types,+Eberts+%26+Gisler,+1999&hl=en&sa=X&ei=EF9tUue5EsjT0QW56IGwCg&ved=0CDgQ6AEwAQ>
- Eberts, M., & Gisler, M. (2006). *Careers for culture lovers and other artsy types* Retrieved from <https://www.google.co.uk/search?q=Careers+for+Culture+Lovers+and+Other+Artsy+Types,+John+Drum+has+owned+his+own+antique+shop+specializing+in+seventeenth+and+eighteenth-century+decorative+furniture%E2%80%99&hl=en&noj=1&source=Inms&tbm=bks&sa=X&ei=jl1tUpOGOqOk0QXoq4CIBg&ved=0CA4QAUoAg&biw=1440&bih=799>
- FAO. (1997). *White Maize: A traditional food grain in developing countries* Retrieved from http://books.google.co.uk/books?id=QH1u4FmRjksC&pg=PA4&dq=The+main+producers+include+Kenya,+Malawi,+Tanzania,+Zambia,+and+Zimbabwe,+countries+in+which+white+maize+represents+two+thirds+and+90+percent+of+total+cereals+production%E2%80%99&hl=en&sa=X&ei=oGttUuncC-_60gW49YGoCw&ved=0CDMQ6AEwAA#v=onepage&q=cereals%20production%E2%80%99&f=false
- G.P.O., U. S. (2002). *United States policy in Iraq* Retrieved from <http://books.google.co.uk/books?id=diI4Ao-cxkkC&q=United+States+Policy+in+Iraq,+2002&dq=United+States+Policy+in+Iraq,+2002&hl=en&sa=X&ei=91ptUraNG-Sr0QWwz4GoCA&sqi=2&ved=0CDEQ6AEwAA>
- Garcia, E., & Lucas, A. (2012). *Sociology of organizations* Retrieved from http://books.google.co.uk/books?id=-2Pc2qcT_u4C&printsec=frontcover&dq=Sociology+of+Organizations&hl=en&sa=X&ei=IEttUsDCIKmr0AWI84AQ&ved=0CD0Q6AEwAg#v=onepage&q=appliances%20industry&f=false

Girard, J. E., & Girard, J. (2011). *Criminalistics: Forensic science, crime, and terrorism* Retrieved from <http://books.google.co.uk/books?id=JRe7qd5u0yAC&pg=PA162&dq=To+ensure+a+complete+document+examination,+a+document+examiner+must+scrutinize+the+documents+in+question+before+this+evidence+is+tested&hl=en&sa=X&ei=R2dtUrL7Humf0QWc9oCACg&ved=0CDwQ6AEwAA#v=onepage&q=document%20examiner%20&f=false>

Green, W. (1993). *Introduction to electronic document management systems* Retrieved from <http://books.google.co.uk/books?id=lzGGHLDERYIC&pg=PA117&dq=The+document+database+is+assumed+to+consist+of+20+million+pages.+It+is+assumed+that+there+is+very+minimal+updating+of+this+database,+only+a+few+thousand+additional+pages+are+added+to+the+data+every+year%E2%80%99&hl=en&sa=X&ei=3mhtUsrTDZT0gW1hoGwCA&ved=0CDMQ6AEwAA#v=onepage&q=document%20database%20&f=false>

Heffetz, O., & Frank, R. (2011). Preferences for status: Evidence from economic implications. In J. Benhabib, M. Mathews & A. Bisin (Eds.), *Handbook of social Economics*. Amsterdam: Elsevier. Retrieved from http://books.google.co.uk/books?id=QAtohqFTJQMC&printsec=frontcover&dq=handbook+of+social+economics&hl=en&sa=X&ei=9VJtUu6WCOLW0QXOsoGwCg&redir_esc=y#v=onepage&q=admission%20office%20&f=false.

Hurley, L., & Lustbader. (1997). Project support: Engaging children and families in the educational process. *Adolescence*, 32, 523-531. <https://www.google.com/url?sa=t&rct=j&q=&esrc=s&source=web&cd=1&ved=0CDQQFjAA&url=http%3A%2F%2Fatriskyouth.wikispaces.com%2Ffile%2Fview%2FPROJECT%2BSUPPORT%2BMentor%2BPrograms.doc&ei=k1JtUoD-LYea1AXiqYGwCA&usq=AFQjCNEkqWvphTb0VM8ykEdsIeu-BxG2OQ&bvm=bv.55123115,d.d2k>

Janik, C. (2009). *The monopoly guide to real estate: rules and strategies for profitable investing* Retrieved from <http://books.google.co.uk/books?id=wcNBDDoUrUgC&pg=PA45&dq=Most+small+towns+have+a+buildings+inspector.+Mid-to-large+cities+have+a+buildings+department+within+which+buildings+inspectors+work%E2%80%A6buildings+inspectors+also+inspect+multifamily+units+and+apartment+houses%E2%80%99&hl=en&sa=X&ei=n2RtUv6WHcjT0QW56IGwCg&ved=0CD8QuwUwAA#v=onepage&q=buildings%20inspector&f=false>

Kaplan, M. (1993). *Barbershopping: Musical and social harmony*. from <http://books.google.co.uk/books?id=KY98anuErg4C&printsec=frontcover&dq=Barbershopping:+Musical+and+Social+Harmony&hl=en&sa=X&ei=D05tUqLeCIOx0QWSpocQCg&ved=0CDMQ6AEwAA#v=onepage&q=admission%20charge%20&f=false>

Kaye, B. (1995). *Science and detective* Retrieved from <http://books.google.co.uk/books?id=kNyPkc2ADTsC&printsec=frontcover&dq=Science+and+Detective,+Kaye&hl=en&sa=X&ei=FmhtUujIM4md0AXzgoH4CQ&ved=0CDQQuwUwAA#v=snippet&q=document%20examiner%20&f=false>

Lee, G. (2011). *Advances in automation and robotics* Retrieved from <http://books.google.co.uk/books?id=da4OxM-AjQcC&pg=PA144&dq=But+to+market,+consumers+and+ordinary+people+who+focus+on+the+vehicles&hl=en&sa=X&ei=OVVtUo2cJqqs0QXZ5YC4CQ&ved=0CDwQ6AEwAA#v=onepage&q=vehicles%20industry&f=false>

Lowry, G., & Turner, R. (2007). *Information systems and technology education: from the university to the workplace* Retrieved from http://books.google.co.uk/books?id=9PHSA_YZtJcC&printsec=frontcover&dq=Information+Systems+and+Technology+Education:+From+the+University+to+the+Workplace,+Glenn+%26+Turner&hl=en&sa=X&ei=0mJtUvWZJqOo0wWkhYHACQ&ved=0CEYQ6AEwAA#v=onepage&q=SKILLS%20SHORTAGE&f=false

Macpherson, K. (2006). *Landscape Painting Inside and Out*, MacPherson Retrieved from <http://books.google.co.uk/books?id=yMObx1gScycC&pg=PA126&dq=Participating+in+a+painting+workshop+is+not+just+for+beginners,+and+it%E2%80%99s+not+just+for+professional+artists.+Anyone+can+benefit+from+the+experience%E2%80%99&hl=en&sa=X&ei=o2FtUuPxF-Gx0AWkyIDoCQ&ved=0CDUQuwUwAA#v=onepage&q=Participating%20in%20a%20painting%20workshop%20is%20not%20just%20for%20beginners%2C%20and%20it%E2%80%99s%20not%20just%20for%20professional%20artists.%20Anyone%20can%20benefit%20from%20the%20experience%E2%80%99&f=false>

- OECD. (2010). *Cutting costs in chemicals management* Retrieved from http://books.google.co.uk/books?id=mJU0MJR7ioMC&pg=PA12&dq=The+chemicals+industry%E2%80%94which+includes+industrial+chemicals,+pharmaceuticals,+pesticides,+biocides,+food,+and+feed+additives+and+cosmetics%E2%80%94is+one+of+the+world%E2%80%99s+largest+industrial+sectors%E2%80%99&hl=en&sa=X&ei=oWltUujxKjTBb3_gNgK&ved=0CDUQuwUwAA#v=onepage&q=chemicals%20industry&f=false
- Oslon, J. (1999). *Historical dictionary of the 1979s* Retrieved from <http://books.google.co.uk/books?id=YKkF8vQRcp0C&pg=PA142&dq=The+enemies+list+was+a+term+given+to+a+plan+in+the+Richard+Nixon&hl=en&sa=X&ei=yU5tUoLXPOOx0AWtpYGgCg&ved=0CDUQ6AEwAA#v=onepage&q=The%20enemies%20list%20was%20a%20term%20given%20to%20a%20plan%20in%20the%20Richard%20Nixon&f=false>
- Pagoso, C., Dinio, R., & Villasis, G. (2008). *Principles of economics* Retrieved from http://books.google.co.uk/books?id=n4gJWEwhHT8C&pg=PA214&dq=Differentiated+oligopoly,+on+the+other+hand,+exists+in+industries+where&hl=en&sa=X&ei=eFRtUqKclqbL0AWP_YC4CQ&ved=0CDEQ6AEwAA#v=onepage&q=Differentiated%20oligopoly%2C%20on%20the%20other%20hand%2C%20exists%20in%20industries%20where&f=false
- Stevenson, D. (2011). *With our backs to the wall* Retrieved from <http://books.google.co.uk/books?id=ouBWCDPh6RUC&pg=PT584&dq=The+most+critical+restraint+on+explosives+production,+however,+was+the+supply+of+nitrates+for+nitric+acid.&hl=en&sa=X&ei=BWttUoWXDIyW0QXJ3YCACQ&ved=0CDYQuwUwAA#v=snippet&q=explosives%20production&f=false>
- Sweatt, D. (1977). A philosophy and public affairs reader. In M. Cohen, T. Nagel & T. Scanlon (Eds.), *Equality and Preferential Treatment*. Retrieved from <http://books.google.co.uk/books?id=3r-vugN4HicC&pg=PA69&dq=Any+admissions+policy+must+put+some+applicants+at+a+disadvantage,+and+a+policy+of+preference+for+minority+applicants+can+reasonably&hl=en&sa=X&ei=WU9tUszSHqOu0QWLi4C4Cw&ved=0CDkQuwUwAQ#v=onepage&q=Any%20admissions%20policy%20must%20put%20some%20applicants%20at%20a%20disadvantage%2C%20and%20a%20policy%20of%20preference%20for%20minority%20applicants%20can%20reasonably&f=false>.

Vincent, M. (2006). *Don't get mad – Get even* Retrieved from <http://books.google.co.uk/books?id=wfBOYC8I8LoC&printsec=frontcover&dq=Don't+Get+Mad%E2%80%94Get+Even&hl=en&sa=X&ei=61ttUpjPOOmF0QWc9oCACg&ved=0CDsQ6AEwAg#v=onepage&q=dinks%20cabinet&f=false>

Welch, E. (2000). *Art in renaissance Italy, 1350–1500* Retrieved from http://books.google.co.uk/books?id=HSWB_UtEAukC&pg=PA351&dq=The+major+paintings+collection+in+Florence+with+a+remarkable+range+of+fifteenth-century+works+from+Tuscany+and+other+regions+of+Italy%E2%80%99&hl=en&sa=X&ei=WmFtUu3fGoyo0wW9_4DYCg&ved=0CDUQuwUwAA#v=onepage&q=The%20major%20paintings%20collection%20in%20Florence%20with%20a%20remarkable%20range%20of%20fifteenth-century%20works%20from%20Tuscany%20and%20other%20regions%20of%20Italy%E2%80%99&f=false

William, R. (1998). *The Informational systems of international inter-governmental organizations* Retrieved from <http://books.google.co.uk/books?id=j3Q0mSk3jr0C&pg=PA19&dq=Habitat+also+issues+a+series+of+specialized+bibliographies+on+a+wide+variety+of+topics+related+to+the+housing+and+human+settlements.+See+the+publication+catalogue+for+a+listing+of+these&hl=en&sa=X&ei=YWRtUtXYIs ex0AW00oGYCg&ved=0CDMQ6AEwAA#v=onepage&q=publication%20catalogue%20&f=false>